

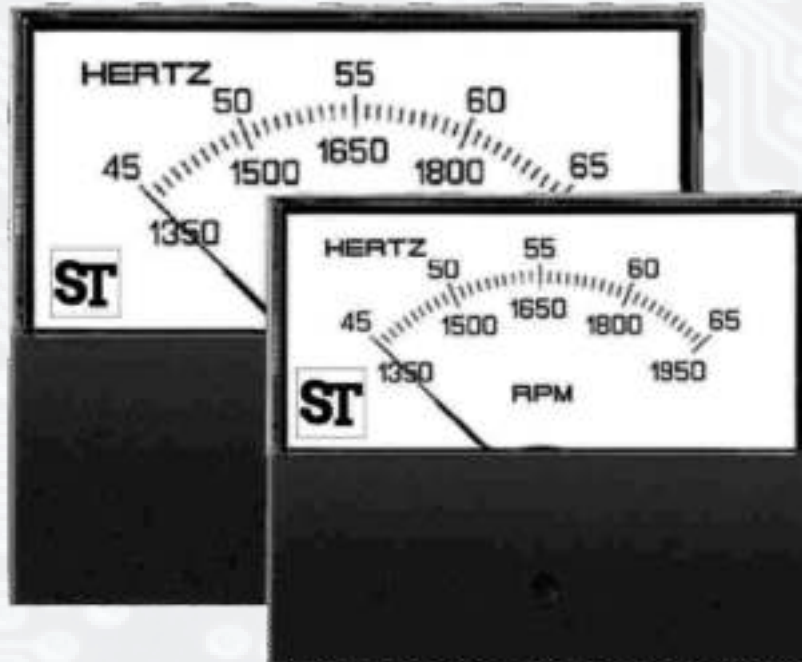

Technical Data Sheet

011 and 012 Anush Series



The Anush range of analog panel meters offers accurate measurement and indication of most electrical and electronic parameters in industry standard sizes. This innovative design features a detachable lower fascia plat which allows the flexibility of either surface or window mounting. The fascia is simply unclipped to achieve the completely flush panel appearance of panel window mounting.

Special Features

- Measuring and indication of AC amps, volts, frequency and DC signals.
- Surface or window mounting.
- High torque pivot and jewel movement.
- True RMS measurement meters.
- AC and DC inputs.
- Up to 40A DC direct connected.
- Up to 50A AC direct connected.

Application

The Anush range of analog panel meters offers accurate measurement and indication of most electrical and electronic parameters in industry standard sizes. This innovative design features a detachable lower fascia plate which allows the flexibility of either surface or window mounting. The fascia is simply unclipped to achieve the completely flush panel appearance of panel window mounting. 1 1/2" and 2 1/2" case Application The range offers AC and DC ammeters, voltmeters and frequency meters utilizing a high torque scale value and features a rear zero adjuster screw for temperproof installation. AC moving iron meters provided high accuracy true RMS measurement of 1.5%.

Applications

- Marine
- Switchgear
- Distribution systems
- Control panels
- Embedded generation
- Energy management
- Building management
- Utility power monitoring
- Process control
- Motor monitoring

Benefits

- AC moving iron and moving coil mechanisms.
- Reduced inventory.
- ANSI standard case sizes.
- Detachable lower fascia plate.

Compliant With

- ANSI C39.1
- IEC 51
- UL 3111-1

Applicable Standards

Nominal case and cutout dimensions for indicating electrical instruments.	DIN 43700
Scale and pointer for electrical measuring instruments.	DIN 43802
Connections and Terminal markings for panel meters	DIN 43807
Terminal bolts / leads	DIN 46200/46282

Clamp straps for connections.	DIN 46282
Safety requirements and protective measures for Electrical indicating instruments and their accessories.	DIN 40050 / 8-70 VDE 0110 /11-72 VDE 0410 /10-76 IEC 529,IEC 1010
Performance specifications for direct acting indicating analogue electrical measuring instruments & their accessories	IEC 51/DIN EN 60051 DIN 43701
Environmental conditions	VDE / VDI 3540
Front frames for indicating measuring instruments principle dimensions.	DIN 43718
UL Compatibility Class	UL 94 V-0
Technical conditions of delivery for electrical instruments.	DIN 43701
Mechanical strength (Free fall test,vibration test)	VDE 0411, part I, Sec.43/44, IEC 1010
E M C compliance as per following standards	E N 50081-2,EN 50082-2,N 55011/CISPR 11, EN 60555-2,IEC 555-2 EN 61000-4-4/IEC 1000-4-4, EN 61000-4-2/IEC 1000-4-2, EN 61000-4-5/IEC 1000-4-5,ENV 50140.

Comply with following European directives:

2004 / 108 / EC (EMC directive) , 2006 / 95 / EC (low voltage directive) & amendment 93/68/EEC, For CE Marking.

Applications

Accuracy	
DC Ammeters and Voltmeters	1.5% 0 to100% of full scale deflection
AC Ammeters and Voltmeters	Moving Iron: 1.5% 10 to 100% of full scale deflection
Frequency Meters	0.5% of end scale value

Input Ratings

DC Moving Coil Ammeters	50mA to 50A
DC Moving Coil Voltmeters	50 mV to 600V
AC Moving Coil Ammeters (VQ)	1mA to 10A
AC Moving Coil Voltmeters (VQ)	6V to 600V
AC Moving Iron Ammeters (EQ)	100mA to 60A
AC Moving Iron Voltmeters (EQ)	6V to 600V
Burden	20 to 500V AC. Standard 900ohms/volt
Frequency Meters	45-55-55Hz, 55-60-65Hz, 45-55-65Hz
Overload	continuous
Voltmeters	2 times for 0.5 sec : 9 overloads 2 times for 5 sec : 1 overload
Ammeters DC Center Zero Voltmeter	10 times for 0.5 sec:9 overloads 10 times for 5 sec : 1 overload

Enclosure

Movement	High torque pivot and jewel moving coil and moving iron
Scale Balance	Within 1% of scale length
Relative Humidity	25% to 80%nominal range of use
Operating Temperature	0° C to +40° C
Storage Temperature	20° C to +55° C
Enclosure Code	IP 42
Case and Cover	Matt black Case UL94V0 Polycarbonate Cover
Bezel	Matt Black
Window	Shatterproof polycarbonate
Fixing	Surface mounting: 4 corner studs 4-40 UNC Rear of panel mounting: 2 through hole mounts
Terminals	011-8-32 UNC 012-1/4"-28 UNC

Compliant With

Performance	ANSI C39.1 and IEC 51
Manufacture	UL3111-1
Scaling	ANSI C39.1
Safety	IEC61010-1 (LVD) and BS EN 61326:(EMC)
Vibration	ANSI C39.1 cl. 5.13

Operation**Moving Coil Meter**

These meters offer a centre cored, self shielding moving coil movement using pivots, hairsprings and sprung jewels. Variations in movement are limited by design. All DC voltmeters are 1000 ohms per volt, moving coil rectified products run at 900 ohms per volt. Millivolt meters use te 5 milliamps/50mV resistance.

Moving Iron Meter

This clapper type repulsion design utilizes a pivot, hairspring and jewel movement. The bottom jewel is oil filled to provide damping while the top is sprung for resilience. All voltmeters are manufactured with internal voltage dropper resistors.

Frequency Meter

Frequency meters use a 1mA/350 ohm movement driven by an EMC hard frequency conversion circuit.feature a highly repeatable flattened are scale shape, ensuring consistently accurate measurement reading. Dials are interchangeable between the challenger range of products using the same input within the published specification of the meter. Options for non standard customer specific dials are available upon request.

Dimension Details

A) 012

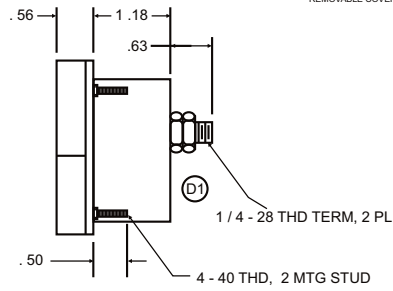
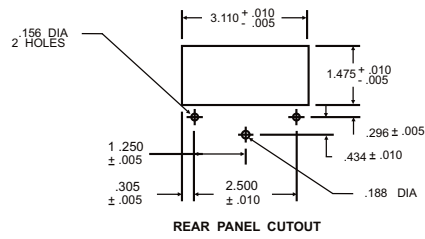
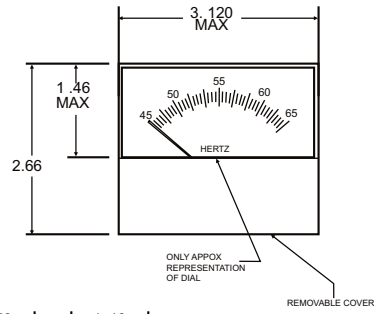
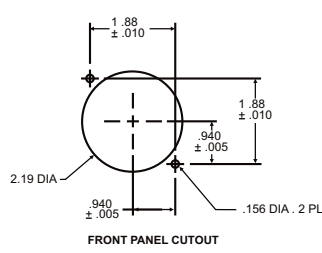

A) 012

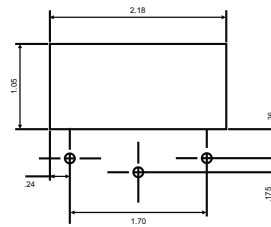
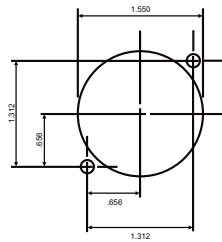
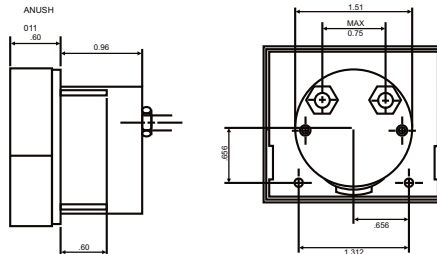
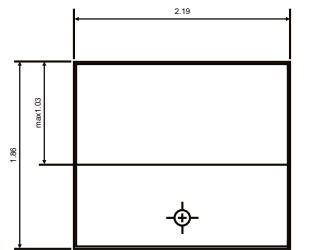

Ordering Information- Only For Representative Products

Anush 012 AC Meter

Part No.	Description	Class
EQ2A-V2BX1AW0000ST	012, 30V AC	CL-1
EQ2A-V2CX1AW0000ST	012, 150V AC	CL-1
EQ2A-V2DX1AW0000ST	012, 300V AC	CL-1
EQ2A-V2FX1AW0000ST	012, 500V AC	CL-1

Part No.	Description	Class
EQ2A-I04X1AX0000ST	012, 5A	CL-1
EQ2A-I05X1AX0000ST	012, 10A	CL-1
EQ2A-I06X1AX0000ST	012, 15A	CL-1
EQ2A-I08X1AX0000ST	012, 25A	CL-1

Anush 012 DC Meter

Part No.	Description	Class
PQ2A-V11L2AW0000ST	012, 10V	CL-1
PQ2A-V12L2AW0000ST	012, 15V	CL-1
PQ2A-V13L2AW0000ST	012, 30V	CL-1
PQ2A-V14L2AW0000ST	012, 50V	CL-1

Part No.	Description	Class
PQ2A-I03L2AW000000	012, 1mA	CL-1
PQ2A-I09L2AW000000	012, 5A	CL-1
PQ2A-I11L2AW000000	012, 10A	CL-1

Anush 012 Frequency Meter

Part No.	Description
ZQ2A-46023AW0000ST	45-55-65 Hz, 240V
ZQ2A-46053AW0000ST	45-55-65 Hz, 120V
ZQ2A-46063AW0000ST	45-55-65 Hz, 480V

Part No.	Description
ZQ2A-56023AW0000ST	55-60-65 Hz, 240V
ZQ2A-56053AW0000ST	55-60-65 Hz, 120V
ZQ2A-56063AW0000ST	55-60-65 Hz, 480V

Anush 011 DC Meter

Part No.	Description	Class
PQ1A-V11L2AW0000ST	011, 10V	CL-1
PQ1A-V12L2AW0000ST	011, 15V	CL-1
PQ1A-V13L2AW0000ST	011, 30V	CL-1
PQ1A-V214L2AW0000ST	011, 50V	CL-1

Part No.	Description	Class
PQ1A-I03L2AW000000	011, 1mA	CL-1
PQ1A-I09L2AW000000	011, 5A	CL-1
PQ1A-I11L2AW000000	011, 10A	CL-1



Sifam Tinsley Instrumentation Inc.
3105, Creekside Village Drive,
Suite No. 801, Kennesaw,
Georgia 30144 (USA)
E-mail Id : psk@sifamtinsley.com
Web : www.sifamtinsley.com
Contact No. : +1 404 736 4903

Sifam Tinsley Instrumentation Ltd
Unit 1 Warner Drive,
Springwood Industrial Estate
Braintree, Essex, UK, CM72YW
E-mail: sales@sifamtinsley.com
Web: www.sifamtinsley.com/uk
Contact: +44(0)1803615139