

DESCRIPTION: FEMALE - SOLDER CUP / MACHINED - PREMIUM

WILL ACCEPT 26-20 AWG WIRE

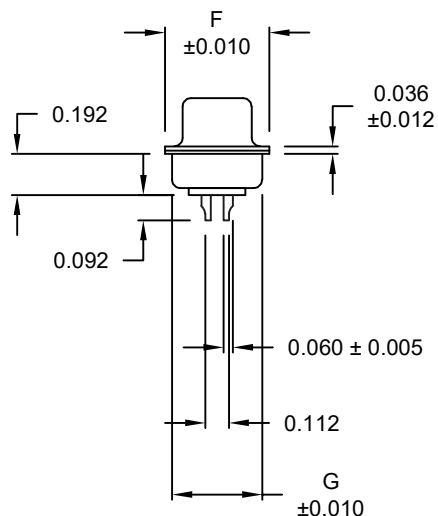
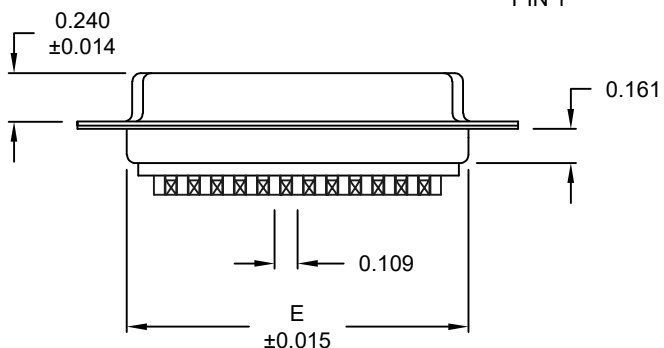
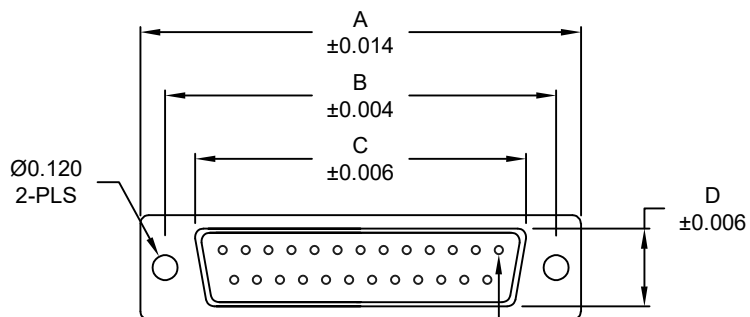

MATERIAL:

SHELL: STEEL, NICKEL PLATED
 INSULATOR: PA6T, UL94 V-0
 PROCESS TEMP.: 260°C
 CONTACT: BRASS

ELECTRICAL:

CURRENT RATING: 5 AMPS
 CONTACT RESISTANCE: 15 mOhms Max.
 INSULATION RESISTANCE: 1,000 MOhms Min.
 VOLTAGE: 500VAC FOR 1 MINUTE
 TEMPERATURE: -50° C TO 100° C

RoHS COMPLIANT

DIMENSIONS

No. OF PINS	A	B	C	D	E	F	G
9	1.213	0.984	0.642	0.315	0.760	0.496	0.429
	30.80	24.99	16.30	8.00	19.30	12.60	10.90
15	1.541	1.312	0.969	0.315	1.083	0.496	0.429
	39.15	33.32	24.60	8.00	27.51	12.60	10.90
25	2.088	1.852	1.512	0.315	1.630	0.496	0.429
	53.04	47.04	38.40	8.00	41.40	12.60	10.90
37	2.729	2.500	2.157	0.315	2.276	0.496	0.429
	69.32	63.50	54.80	8.00	57.81	12.60	10.90
50	2.635	2.406	2.059	0.425	2.182	0.598	0.535
	66.93	61.11	52.30	10.80	55.42	15.20	13.60

172-YYY-203RYY1

SERIES _____
 POSITIONS _____
 009
 015
 025
 037
 050
 GENDER _____
 2 = FEMALE
 TERMINATION _____
 0 = SOLDER CUP
 SHELL PLATING _____
 3 = NICKEL
 HARDWARE OPTIONS _____
 00 = NO HARDWARE
 01 = .065" CLINCH NUT (SOLDER SIDE)
 02 = .250" CLINCH NUT (SOLDER SIDE)
 03 = .250" CLINCH NUT (MATING SIDE)
 05 = .237" 4-40 BOARD LOCK
 91 = .237" 4-40 SPACER/ BOARD LOCK
 PLATING OPTIONS _____
 1 = GOLD FLASH
 2 = 30MICRO-INCH GOLD

DO NOT SCALE FROM DRAWING

	THESE DRAWINGS AND SPECIFICATIONS ARE THE PROPERTY OF NorComp AND SHALL NOT BE REPRODUCED, COPIED OR USED AS THE BASIS FOR THE MANUFACTURE OF SALE OF APPARATUS WITHOUT WRITTEN PERMISSION.		DRAWN: PAM JENKINS	DATE: 08-24-98
	NorComp		SCALE: NTS	SHEET OF 1 2
DWG NO. 172-YYY-203RYY1				

ALL CLINCH-NUTS ARE 4-40 INTERNAL THREADS

01X 0.065" (SOLDER SIDE)

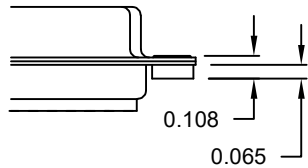

02X 0.250" (SOLDER SIDE)

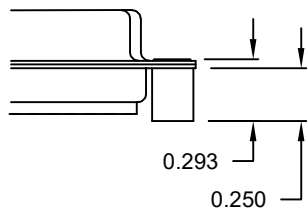

03X..... 0.250" (MATING SIDE)

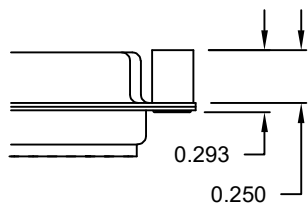

05X 0.237" (SOLDER SIDE)

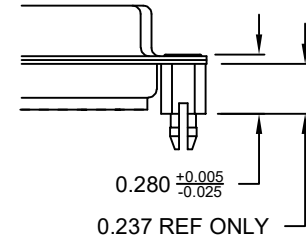

91X 0.237" (SOLDER SIDE)

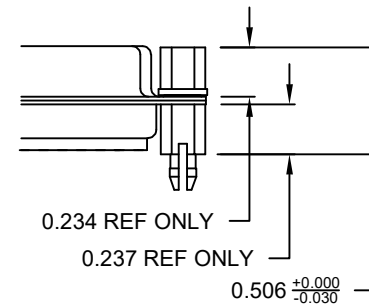

NOTE: 4-40 FEMALE SCREW LOCK IS REMOVABLE

TOLERANCE:
ALL DIMENSIONS ARE ± 0.010
UNLESS OTHERWISE
SPECIFIED

DO NOT SCALE FROM DRAWING

RoHS COMPLIANT

	THESE DRAWINGS AND SPECIFICATIONS ARE THE PROPERTY OF NorComp AND SHALL NOT BE REPRODUCED, COPIED OR USED AS THE BASIS FOR THE MANUFACTURE OF SALE OF APPARATUS WITHOUT WRITTEN PERMISSION.		DRAWN: PAM JENKINS	DATE: 08-24-98
			SCALE: NTS	SHEET OF 2 2
<h1>NorComp</h1>			DWG NO. 172-YYY-203RYY1	