

Device Features

- OIP3 = 51.0 dBm @ 1900 MHz
- Gain = 14.0 dB @ 1900 MHz
- Output P1 dB = 33.3 dBm @ 1900 MHz
- Highly Reliable InGaP/GaAs HBT Technology
- RoHS2-compliant SOIC-8 SMT package

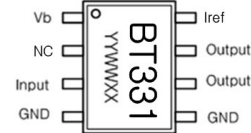

YY = Year, WW = Work week,
XX = Wafer Number

Product Description

BeRex's BT331 is a high power and a high dynamic range amplifier in a low cost surface mount package(SOIC-8) with a RoHS2-compliant, that incorporates reliable hetero-junction-bipolar-transistor (HBT) devices fabricated with InGaP GaAs technology. This device is designed for use where high linearity is required and features high OIP3 and Power with low consumption current (400mA) and requires a few external matching components such as a DC blocking capacitors on the In/Output pin, a bypass capacitor and a RF choke for the out port. All devices are 100% RF/DC tested.

Applications

- Base station Infrastructure/RFID
- Commercial/Industrial/Military wireless system
- Wireless LAN

Application Circuits

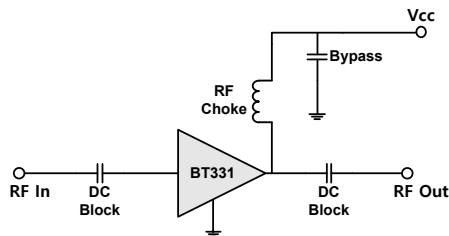

*External matching circuit: refer to the page 4 to 16.

Electrical Specifications

Device performance _ measured on a BeRex evaluation board at 25°C, Vc=5V, 50 Ω system.

Parameter	Conditions	Min	Typ	Max	Unit
Operational		700		4000	MHz
Test Frequency			1900		MHz
Gain		12.5	14.0		dB
Input Return Loss			-14.0		dB
Output Return Loss			-11.0		dB
Output IP3	20 dBm/tone,	48.0	51.0		dBm
Output P1dB		32.3	33.3		dBm
WCDMA 1FA ACLR*		22.2	23.2		dBm
WCDMA 4FA ACLR*		21.0	22.0		dBm
Noise Figure			5.0		dB

*ACPR CH Power is measured at 55dBc, ACLR CH Power _ measured at 50dBc.

- ACPR Test set-up: IS-95 CDMA, 9Ch. FWD, +885KHz offset, PAR 9.7dB at 0.01% Prob.

- ACLR Test set-up: 3GPP WCDMA, TM1+64DPCH, +5MHz offset, PAR 10.34 at 0.01% Prob.

Recommended Operating Conditions

Parameter	Min	Typ	Max	Unit
Bandwidth	700		4000	MHz
I _C @ (V _c = 5V)	340	415	490	mA
V _C	4.75	5.0	5.25	V
R _{TH}		10.0		°C/W
Operating Case Temperature	-40		+85	°C

Electrical specifications are measured at specified test conditions.

Specifications are not guaranteed over all recommended operating conditions.

Absolute Maximum Ratings

Parameter	Rating	Unit
Storage Temperature	-55 to +155	°C
Junction Temperature	+170	°C
Supply Voltage	+5.5	V
Supply Current	900	mA
Input RF Power	28	dBm

*Operation of this device above any of these parameters may result in permanent damage.

Typical Performance (Vc=5V, Ic=415mA, T=25°C)

Parameter	Frequency						Unit
	900	1900	2140	2450	2600	3500	
Gain	19.5	14.0	13.0	12.0	12.1	10.7	dB
S11	-16.0	-14.0	-15.0	-20.0	-19.0	-20.4	dB
S22	-11.0	-11.0	-12.0	-10.0	-12.7	-13.0	dB
OIP3	50.0	51.0	51.0	50.0	47.0	45.8	dBm
P1dB	31.5	33.3	32.3	31.0	31.2	29.5	dBm
IS-95C ACPR	23.3	-	-	-	-	-	dBm
WCDMA ACLR	-	23.3	23.4	21.5	21.5	20.1	dBm
Noise Figure	4.8	5.0	5.0	5.3	5.4	6.2	dB

V-I Characteristics

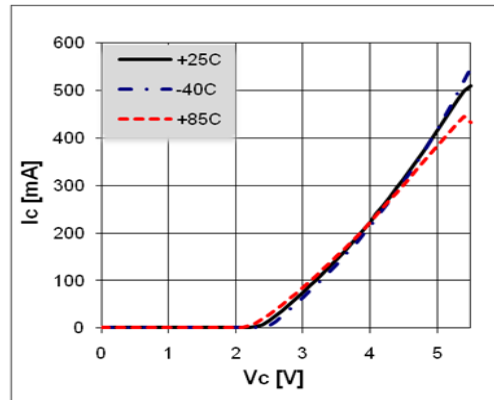

BeRex SOIC-8 Evaluation Board

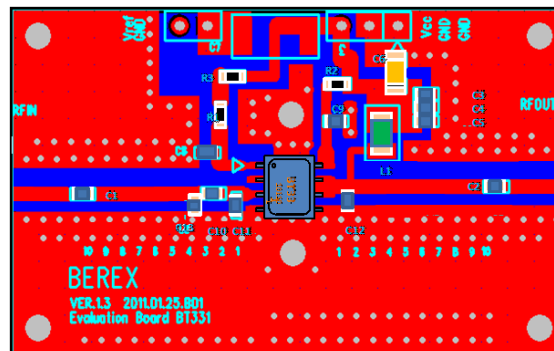

*Dielectric constant _ 4.2 *RF pattern width 52mil *31mil thick FR4 PCB

Typical Device Data

S-parameters (Vc=5V, Ic=415mA, T=25°C)

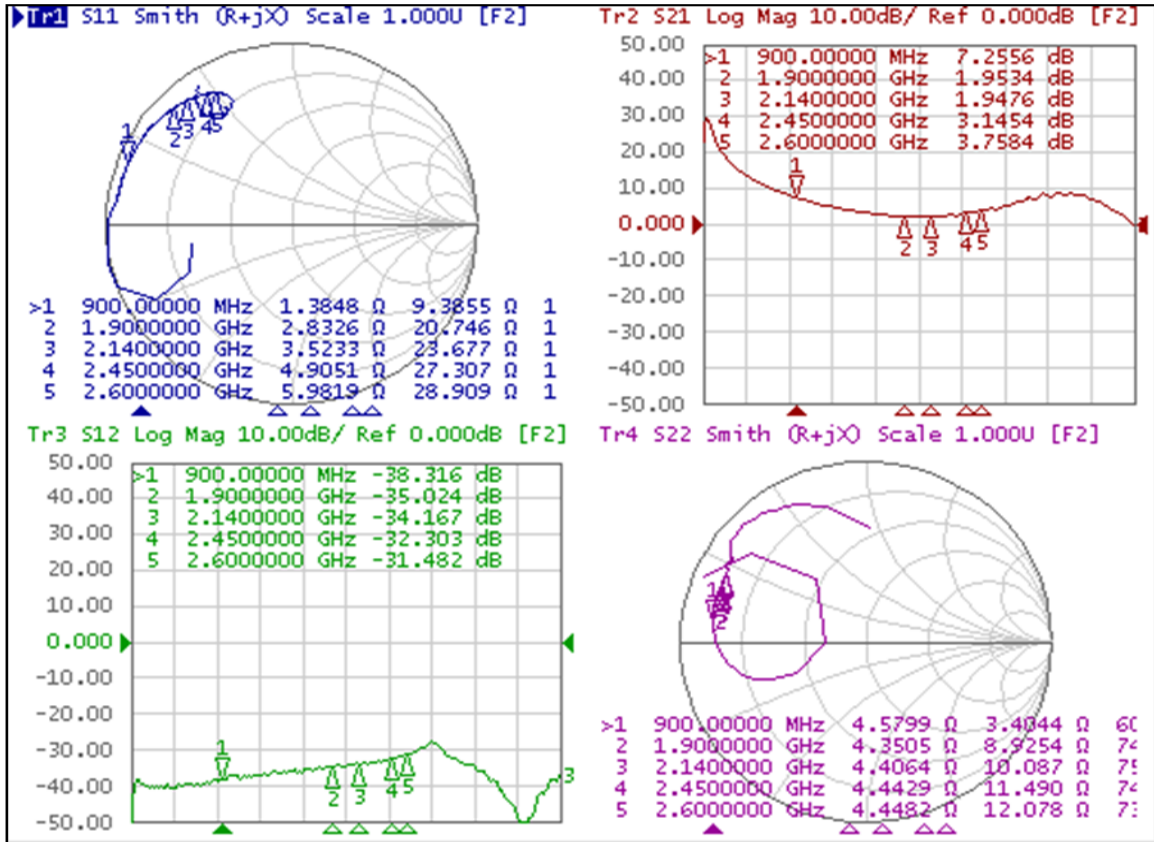

S-Parameter

(Vdevice = 5.0V, Icc = 415mA, T = 25 °C, calibrated to device leads)

Freq [MHz]	S11 [Mag]	S11 [Ang]	S21 [Mag]	S21 [Ang]	S12 [Mag]	S12 [Ang]	S22 [Mag]	S22 [Ang]
	100	0.919	-155.332	27.202	171.888	0.011	81.778	0.335
500	0.949	168.743	4.153	90.122	0.010	35.600	0.805	-179.714
1000	0.941	156.029	2.065	78.875	0.011	47.384	0.833	170.693
1500	0.929	143.815	1.444	71.101	0.016	48.347	0.840	163.704
2000	0.895	131.767	1.226	65.133	0.019	50.235	0.838	158.159
2500	0.847	120.721	1.393	57.189	0.024	47.782	0.839	153.001
3000	0.735	118.042	2.132	32.334	0.024	2.709	0.848	147.516
3500	0.757	125.918	2.326	-38.115	0.007	-11.874	0.904	140.189
4000	0.910	122.065	0.796	-127.288	0.014	66.759	0.495	79.167

Application Circuit: 900 MHz

Schematic Diagram	BOM	Tolerance																																																																
	<table border="1"> <tr><td>C1</td><td>0603</td><td>100pF</td><td>±5%</td></tr> <tr><td>C2</td><td>0603</td><td>100pF</td><td>±5%</td></tr> <tr><td>C3</td><td>0603</td><td>100pF</td><td>±5%</td></tr> <tr><td>C4</td><td>0603</td><td>1nF</td><td>±5%</td></tr> <tr><td>C5</td><td>0603</td><td>1uF</td><td>±5%</td></tr> <tr><td>C6</td><td>1206</td><td>10uF</td><td>±20%</td></tr> <tr><td>C7</td><td></td><td>NC</td><td></td></tr> <tr><td>C8</td><td></td><td>NC</td><td></td></tr> <tr><td>C9</td><td>0603</td><td>1pF</td><td>±5%</td></tr> <tr><td>C10</td><td>0603</td><td>3.3pF</td><td>±5%</td></tr> <tr><td>C11</td><td>0603</td><td>10pF</td><td>±5%</td></tr> <tr><td>C12</td><td>0603</td><td>8pF</td><td>±5%</td></tr> <tr><td>L1</td><td>1008</td><td>18nH</td><td>±5%</td></tr> <tr><td>L2</td><td>0603</td><td>8.2nH</td><td>±5%</td></tr> <tr><td>R1</td><td>0603</td><td>4.3KΩ</td><td>±5%</td></tr> <tr><td>R2</td><td>0603</td><td>100Ω</td><td>±5%</td></tr> </table>	C1	0603	100pF	±5%	C2	0603	100pF	±5%	C3	0603	100pF	±5%	C4	0603	1nF	±5%	C5	0603	1uF	±5%	C6	1206	10uF	±20%	C7		NC		C8		NC		C9	0603	1pF	±5%	C10	0603	3.3pF	±5%	C11	0603	10pF	±5%	C12	0603	8pF	±5%	L1	1008	18nH	±5%	L2	0603	8.2nH	±5%	R1	0603	4.3KΩ	±5%	R2	0603	100Ω	±5%	
	C1	0603	100pF	±5%																																																														
	C2	0603	100pF	±5%																																																														
	C3	0603	100pF	±5%																																																														
	C4	0603	1nF	±5%																																																														
	C5	0603	1uF	±5%																																																														
	C6	1206	10uF	±20%																																																														
	C7		NC																																																															
	C8		NC																																																															
	C9	0603	1pF	±5%																																																														
	C10	0603	3.3pF	±5%																																																														
	C11	0603	10pF	±5%																																																														
	C12	0603	8pF	±5%																																																														
	L1	1008	18nH	±5%																																																														
L2	0603	8.2nH	±5%																																																															
R1	0603	4.3KΩ	±5%																																																															
R2	0603	100Ω	±5%																																																															
PCB Diagram	Notice																																																																	
	<ol style="list-style-type: none"> 1. PCB: 31mil thick FR4 2. Distance between the center of the shunt Inductor(L2) and the input pin of BT331 _ 6.45 mm. 3. Distance between the center of the series cap.(C10) and the input pin of BT331 _ 2.8mm. 4. Distance between the center of the shunt cap.(C11) and the input pin of BT331 _ 1.5 mm. 5. Distance between the center of the shunt cap.(C12) and the output pin of BT331 _ 8.25 mm. <p>※ BT331 with both input and output ports opened simultaneously may cause instability. Please See an application note or contact company for application support.</p>																																																																	

Typical Performance
($V_c=5V, I_{cq}=415mA, T=25^\circ C$)

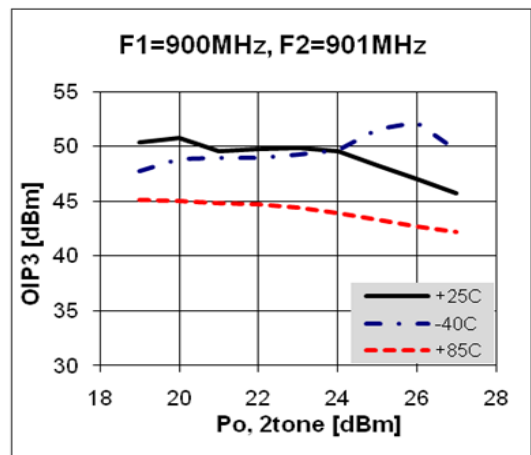
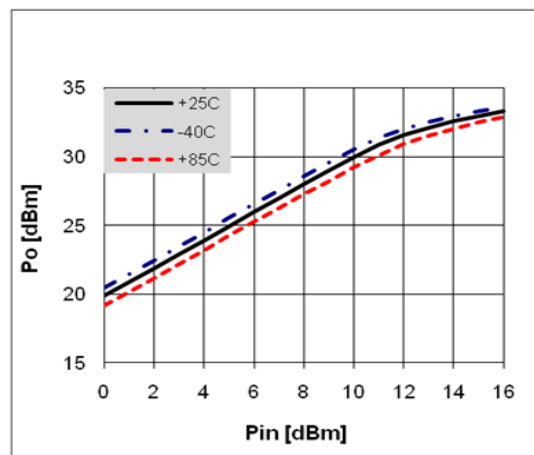
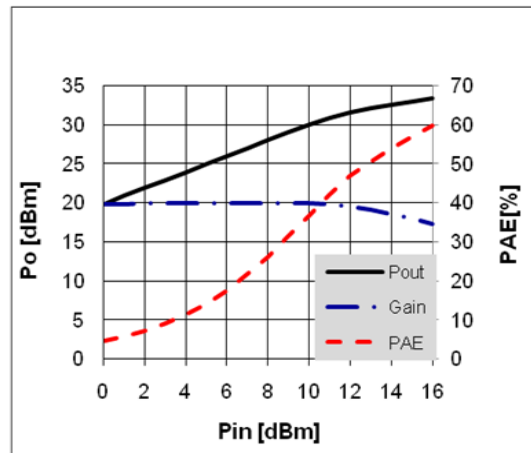
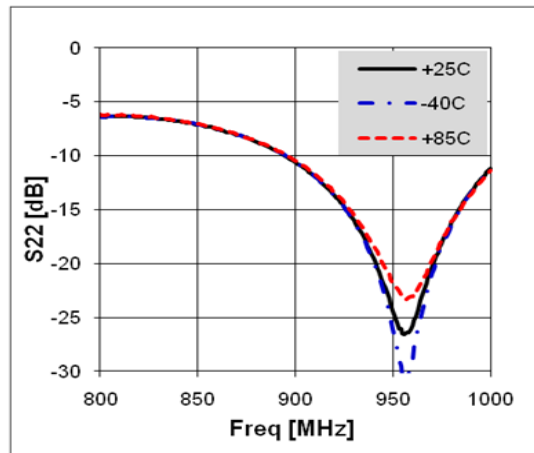
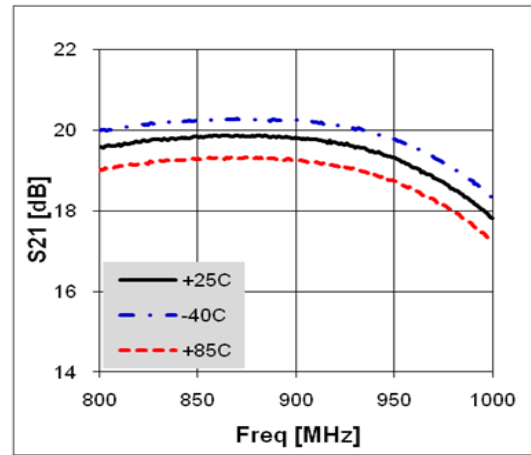
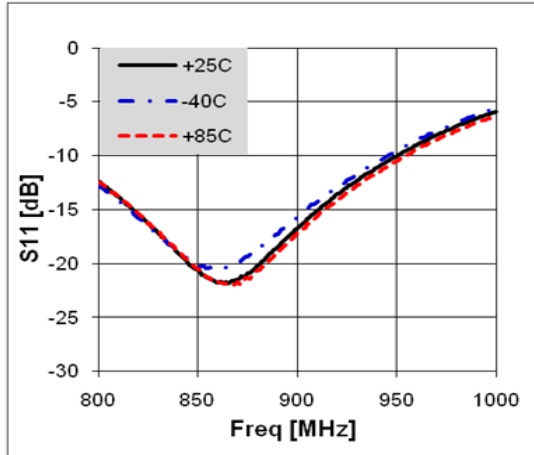

700-4000 MHz 1.5~2.0W Power Amplifier

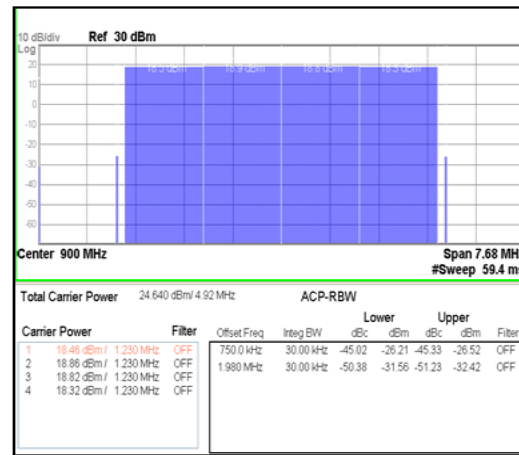
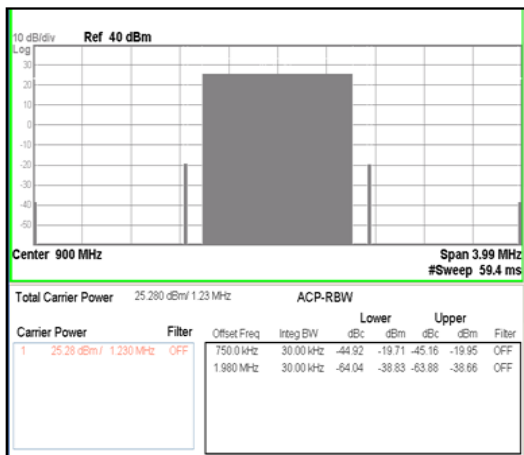
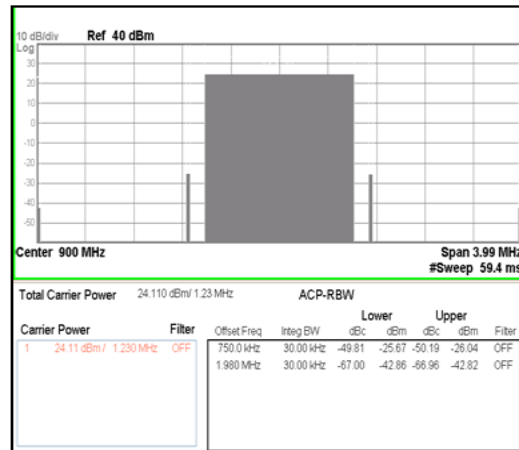
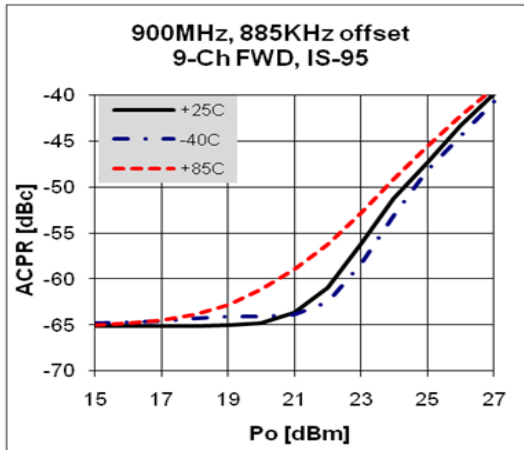

Application Circuit: 1900 MHz

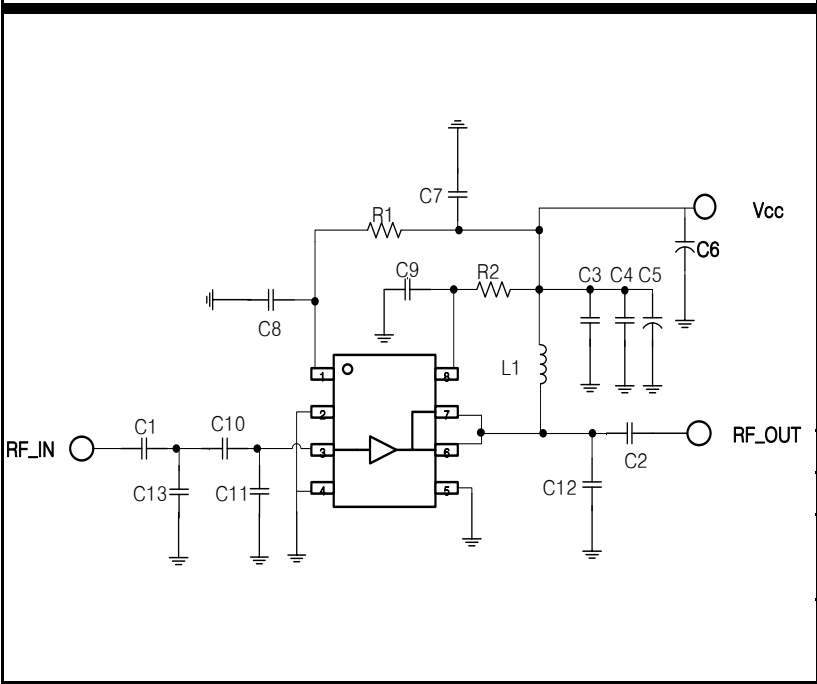
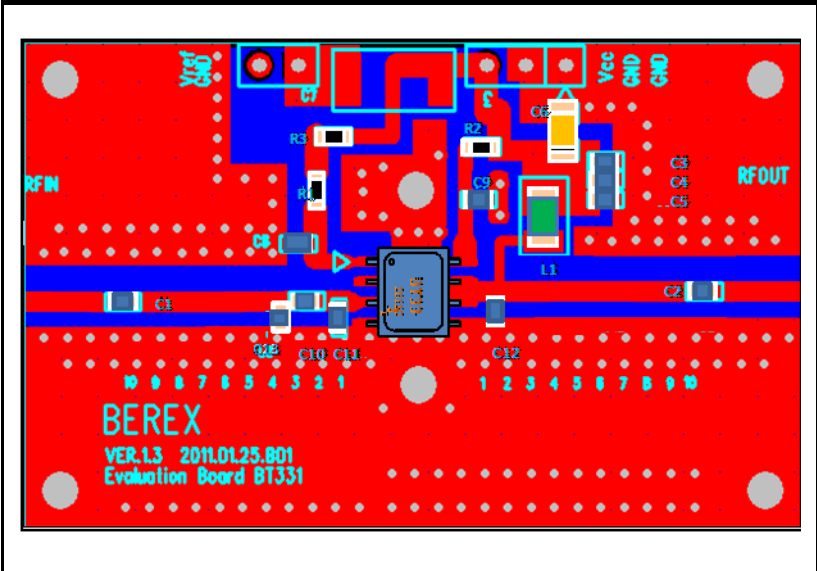
Schematic Diagram	BOM	Tolerance		
	C1	0603	100pF	±5%
	C2	0603	100pF	±5%
	C3	0603	100pF	±5%
	C4	0603	1nF	±5%
	C5	0603	1uF	±5%
	C6	1206	10uF	±20%
	C7		NC	
	C8	0603	2pF	±5%
	C9	0603	10pF	±5%
	C10	0603	3pF	±5%
	C11	0603	0.5pF	±5%
	C12	0603	2.7pF	±5%
	C13	0603	2.5pF	±5%
	L1	1008	56nH	±5%
R1	0603	4.3KΩ	±5%	
R2	0603	100Ω	±5%	
PCB Diagram	Notice			
	<ol style="list-style-type: none"> 1. PCB: 31mil thick FR4 2. Distance between the center of the shunt cap.(C13) and the input pin of BT331 _ 5.25 mm. 3. Distance between the center of the series cap.(C10) and the input pin of BT331 _ 2.8mm. 4. Distance between the center of the shunt cap.(C11) and the input pin of BT331 _ 1.5 mm. 5. Distance between the center of the shunt cap.(C12) and the output pin of BT331 _ 2.25 mm. 			

Typical Performance
($V_c=5V, I_{cq}=415mA, T=25^\circ C$)

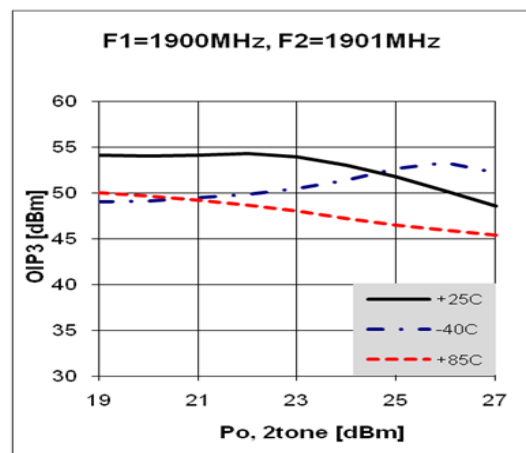
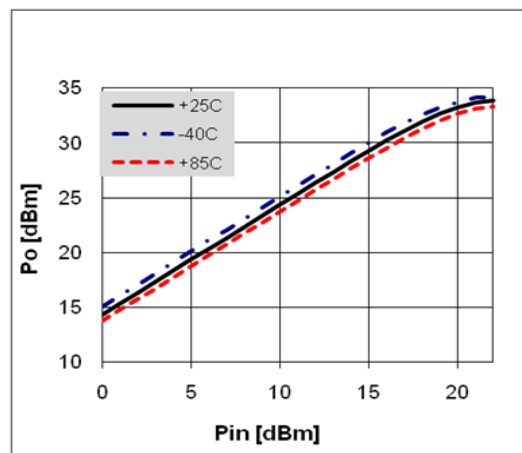
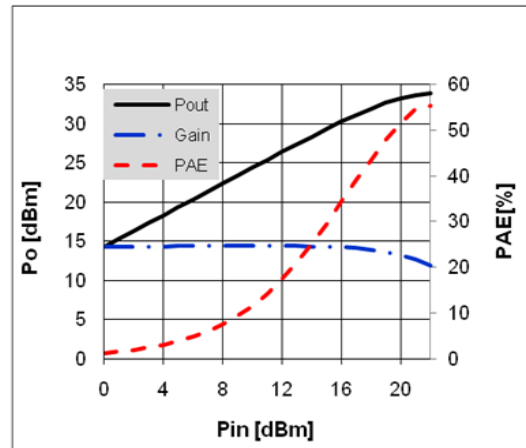
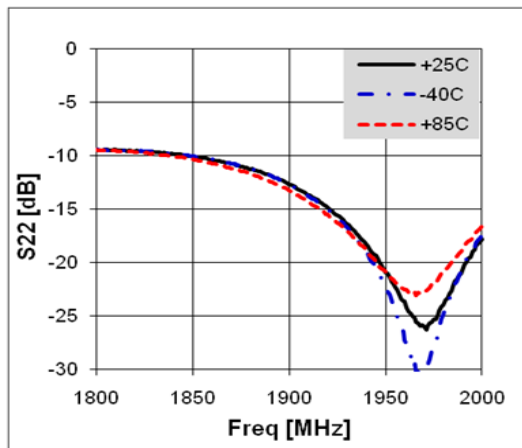
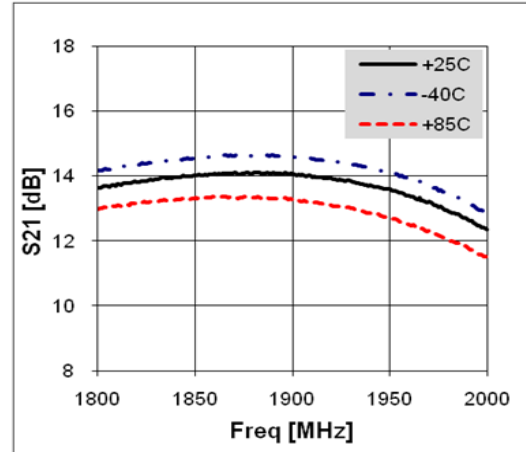
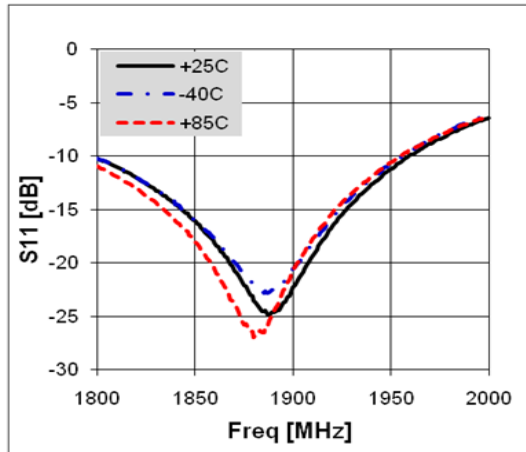

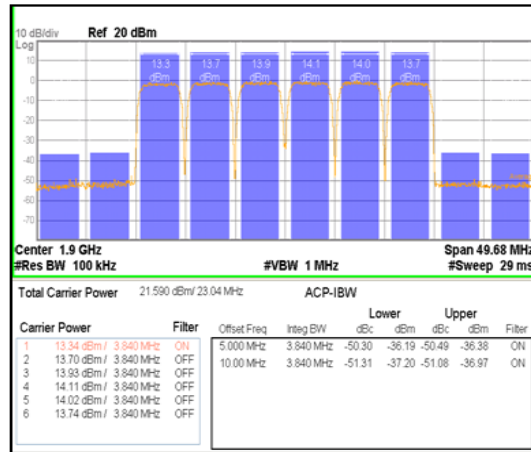
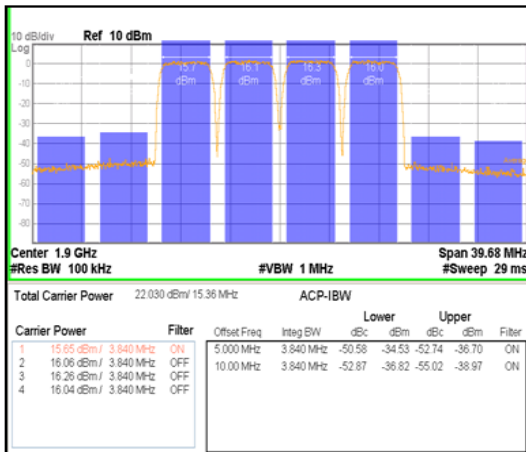
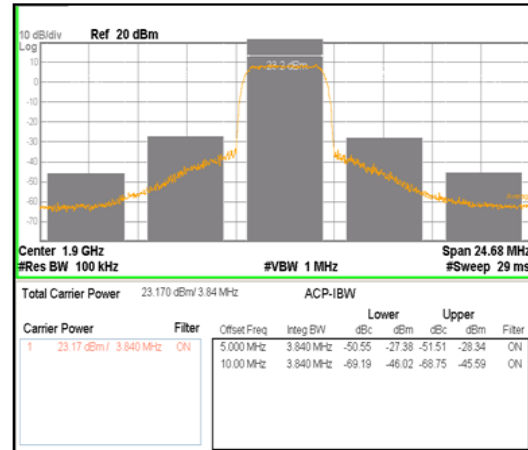
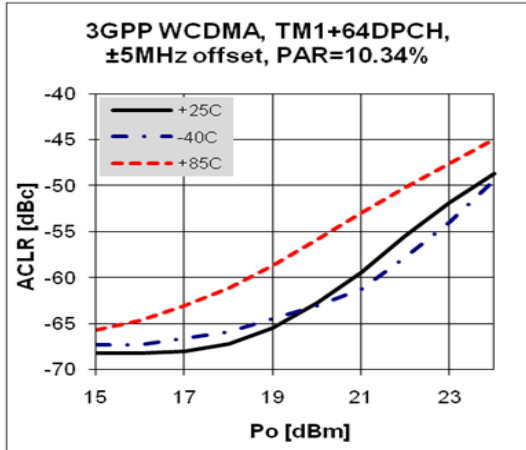

Application Circuit: 2140 MHz

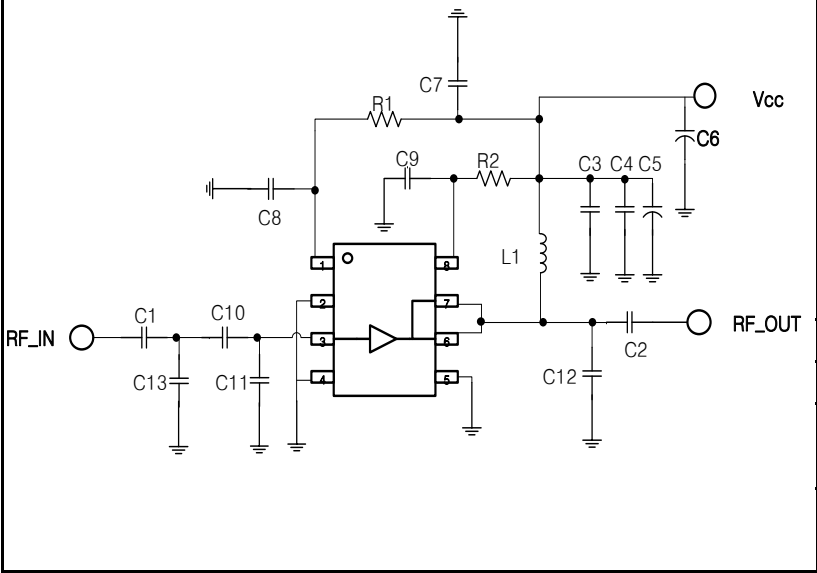
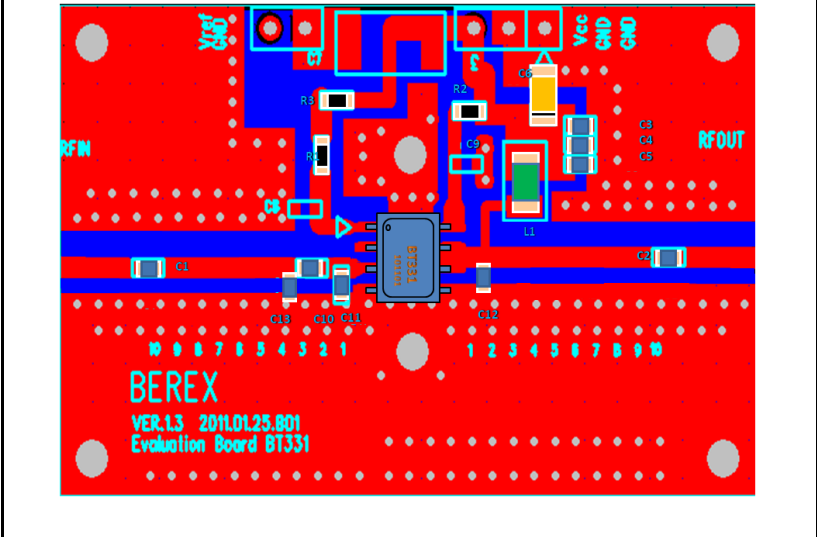
Schematic Diagram	BOM	Tolerance																																																																
	<table border="1"> <tr><td>C1</td><td>0603</td><td>100pF</td><td>±5%</td></tr> <tr><td>C2</td><td>0603</td><td>100pF</td><td>±5%</td></tr> <tr><td>C3</td><td>0603</td><td>100pF</td><td>±5%</td></tr> <tr><td>C4</td><td>0603</td><td>1nF</td><td>±5%</td></tr> <tr><td>C5</td><td>0603</td><td>1uF</td><td>±5%</td></tr> <tr><td>C6</td><td>1206</td><td>10uF</td><td>±20%</td></tr> <tr><td>C7</td><td></td><td>NC</td><td></td></tr> <tr><td>C8</td><td>0603</td><td>5pF</td><td>±5%</td></tr> <tr><td>C9</td><td></td><td>NC</td><td></td></tr> <tr><td>C10</td><td>0603</td><td>1.8pF</td><td>±5%</td></tr> <tr><td>C11</td><td>0603</td><td>0.5pF</td><td>±5%</td></tr> <tr><td>C12</td><td>0603</td><td>2pF</td><td>±5%</td></tr> <tr><td>C13</td><td>0603</td><td>2pF</td><td>±5%</td></tr> <tr><td>L1</td><td>1008</td><td>22nH</td><td>±5%</td></tr> <tr><td>R1</td><td>0603</td><td>5.6KΩ</td><td>±5%</td></tr> <tr><td>R2</td><td>0603</td><td>100Ω</td><td>±5%</td></tr> </table>	C1	0603	100pF	±5%	C2	0603	100pF	±5%	C3	0603	100pF	±5%	C4	0603	1nF	±5%	C5	0603	1uF	±5%	C6	1206	10uF	±20%	C7		NC		C8	0603	5pF	±5%	C9		NC		C10	0603	1.8pF	±5%	C11	0603	0.5pF	±5%	C12	0603	2pF	±5%	C13	0603	2pF	±5%	L1	1008	22nH	±5%	R1	0603	5.6KΩ	±5%	R2	0603	100Ω	±5%	
	C1	0603	100pF	±5%																																																														
	C2	0603	100pF	±5%																																																														
	C3	0603	100pF	±5%																																																														
	C4	0603	1nF	±5%																																																														
	C5	0603	1uF	±5%																																																														
	C6	1206	10uF	±20%																																																														
	C7		NC																																																															
	C8	0603	5pF	±5%																																																														
	C9		NC																																																															
	C10	0603	1.8pF	±5%																																																														
	C11	0603	0.5pF	±5%																																																														
	C12	0603	2pF	±5%																																																														
	C13	0603	2pF	±5%																																																														
L1	1008	22nH	±5%																																																															
R1	0603	5.6KΩ	±5%																																																															
R2	0603	100Ω	±5%																																																															
PCB Diagram	Notice																																																																	
	<ol style="list-style-type: none"> 1. PCB: 31mil thick FR4 2. Distance between the center of the shunt cap.(C13) and the input pin of BT331 _ 5.25 mm. 3. Distance between the center of the series cap.(C10) and the input pin of BT331 _ 2.8mm. 4. Distance between the center of the shunt cap.(C11) and the input pin of BT331 _ 1.5 mm. 5. Distance between the center of the shunt cap.(C12) and the output pin of BT331 _ 2.25 mm. 																																																																	

Typical Performance
($V_c=5V, I_{cq}=415mA, T=25^\circ C$)

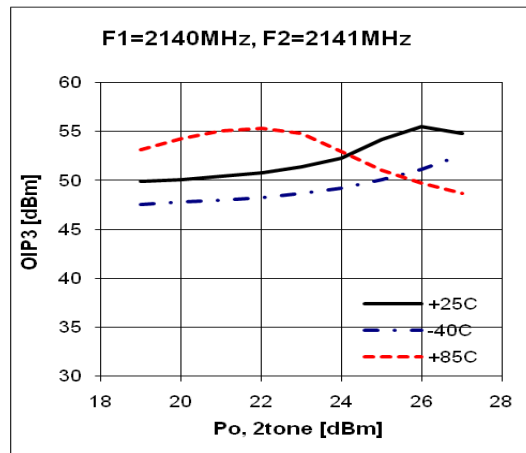
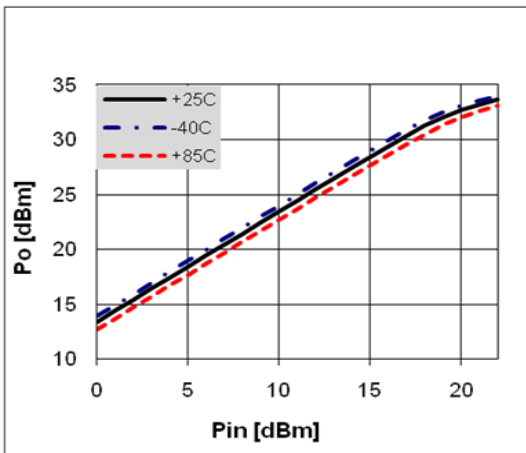
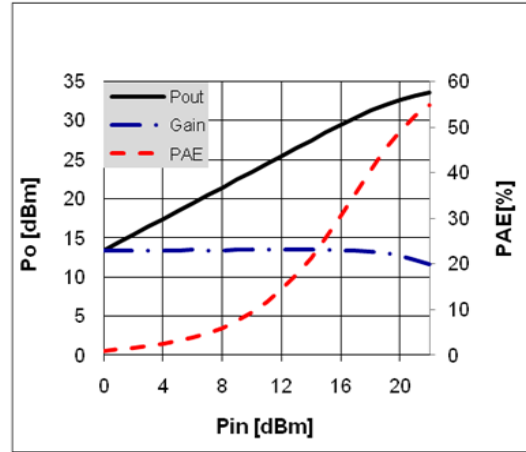
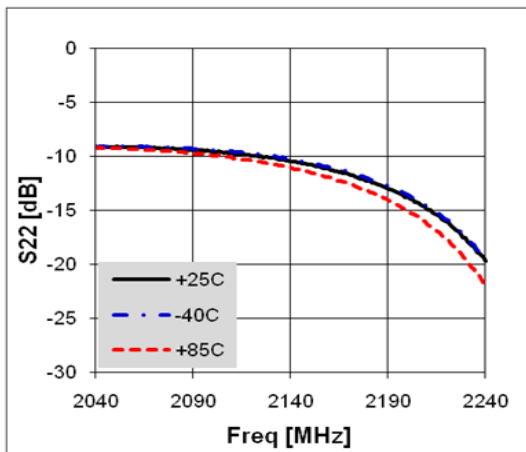
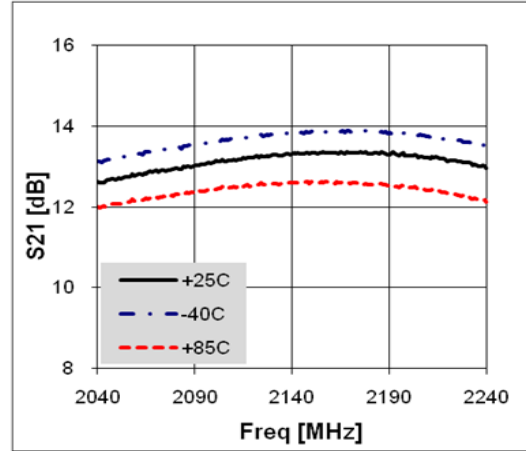
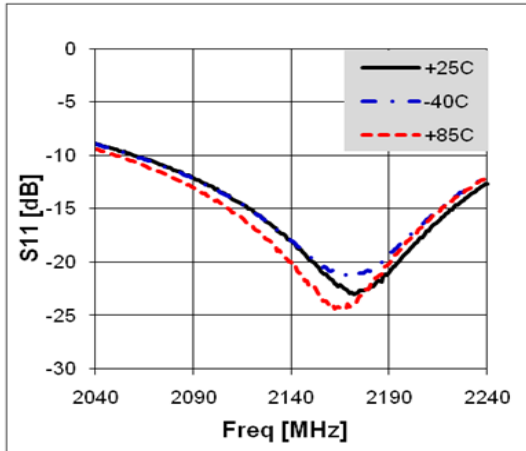

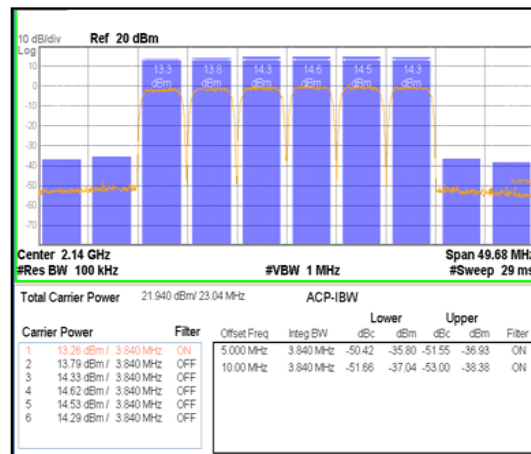
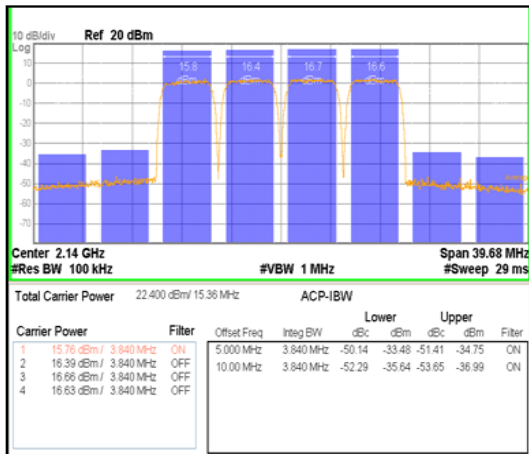
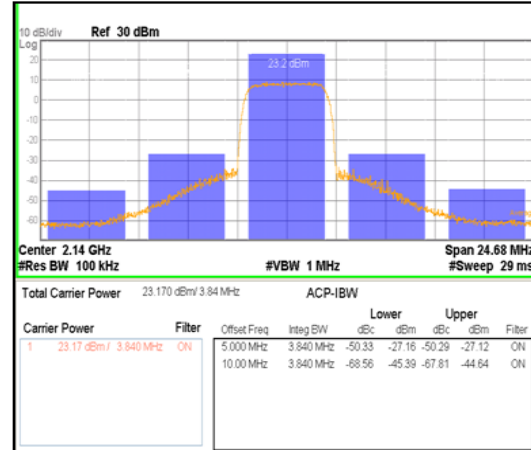
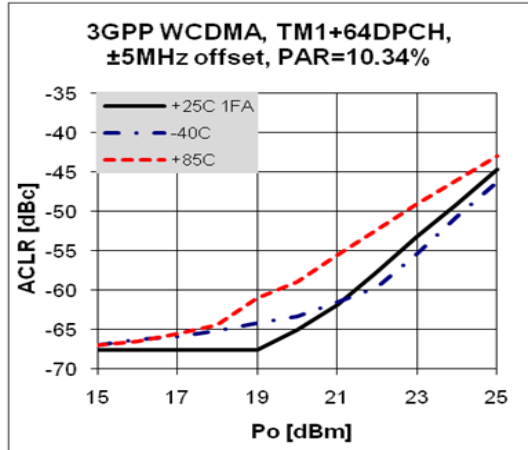

Application Circuit: 2450 MHz

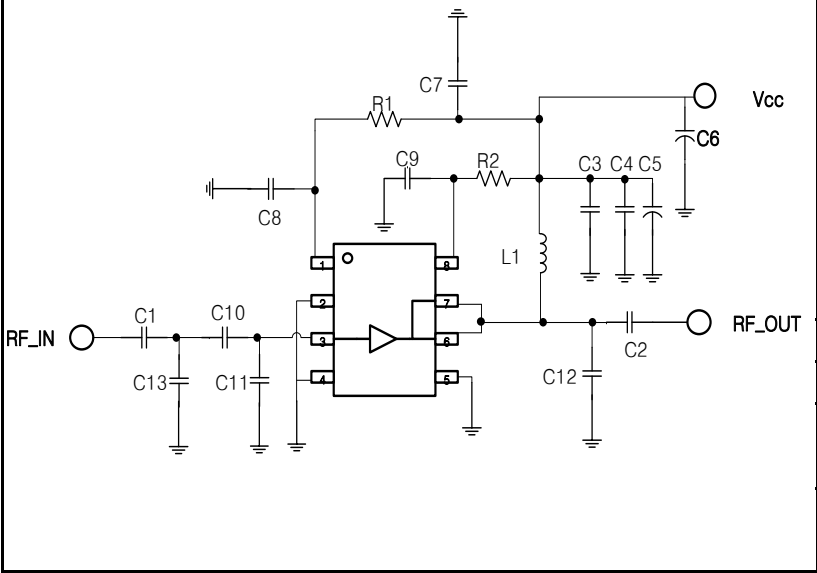
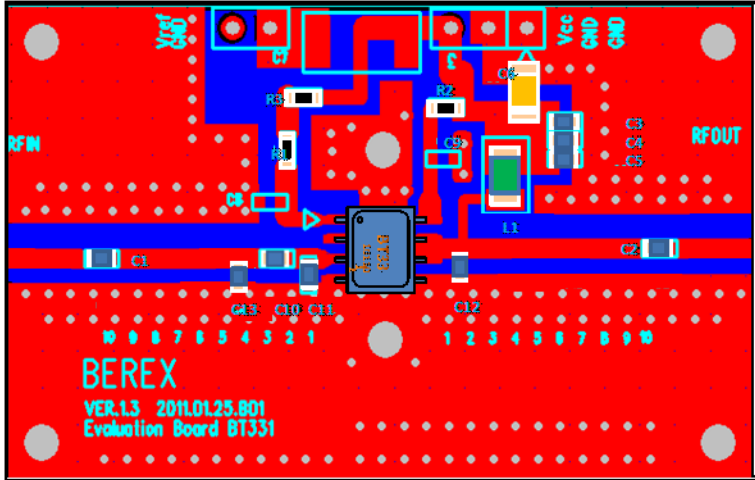
Schematic Diagram	BOM	Tolerance																																																																
	<table border="1"> <tr><td>C1</td><td>0603</td><td>100pF</td><td>±5%</td></tr> <tr><td>C2</td><td>0603</td><td>100pF</td><td>±5%</td></tr> <tr><td>C3</td><td>0603</td><td>100pF</td><td>±5%</td></tr> <tr><td>C4</td><td>0603</td><td>1nF</td><td>±5%</td></tr> <tr><td>C5</td><td>0603</td><td>1uF</td><td>±5%</td></tr> <tr><td>C6</td><td>1206</td><td>10uF</td><td>±20%</td></tr> <tr><td>C7</td><td></td><td>NC</td><td></td></tr> <tr><td>C8</td><td></td><td>NC</td><td></td></tr> <tr><td>C9</td><td></td><td>NC</td><td></td></tr> <tr><td>C10</td><td>0603</td><td>1pF</td><td>±5%</td></tr> <tr><td>C11</td><td>0603</td><td>0.5pF</td><td>±5%</td></tr> <tr><td>C12</td><td>0603</td><td>1.8pF</td><td>±5%</td></tr> <tr><td>C13</td><td>0603</td><td>1pF</td><td>±5%</td></tr> <tr><td>L1</td><td>1008</td><td>5.7nH</td><td>±5%</td></tr> <tr><td>R1</td><td>0603</td><td>5.6KΩ</td><td>±5%</td></tr> <tr><td>R2</td><td>0603</td><td>100Ω</td><td>±5%</td></tr> </table>	C1	0603	100pF	±5%	C2	0603	100pF	±5%	C3	0603	100pF	±5%	C4	0603	1nF	±5%	C5	0603	1uF	±5%	C6	1206	10uF	±20%	C7		NC		C8		NC		C9		NC		C10	0603	1pF	±5%	C11	0603	0.5pF	±5%	C12	0603	1.8pF	±5%	C13	0603	1pF	±5%	L1	1008	5.7nH	±5%	R1	0603	5.6KΩ	±5%	R2	0603	100Ω	±5%	
	C1	0603	100pF	±5%																																																														
	C2	0603	100pF	±5%																																																														
	C3	0603	100pF	±5%																																																														
	C4	0603	1nF	±5%																																																														
	C5	0603	1uF	±5%																																																														
	C6	1206	10uF	±20%																																																														
	C7		NC																																																															
	C8		NC																																																															
	C9		NC																																																															
	C10	0603	1pF	±5%																																																														
	C11	0603	0.5pF	±5%																																																														
	C12	0603	1.8pF	±5%																																																														
	C13	0603	1pF	±5%																																																														
L1	1008	5.7nH	±5%																																																															
R1	0603	5.6KΩ	±5%																																																															
R2	0603	100Ω	±5%																																																															
PCB Diagram	Notice																																																																	
	<ol style="list-style-type: none"> 1. PCB: 31mil thick FR4 2. Distance between the center of the shunt cap.(C13) and the input pin of BT331 _ 6.0 mm. 3. Distance between the center of the series cap.(C10) and the input pin of BT331 _ 2.8mm. 4. Distance between the center of the shunt cap.(C11) and the input pin of BT331 _ 1.5 mm. 5. Distance between the center of the shunt cap.(C12) and the output pin of BT331 _ 2.5 mm. 																																																																	

Typical Performance
(Vc=5V, Icq=415mA, T=25°C)

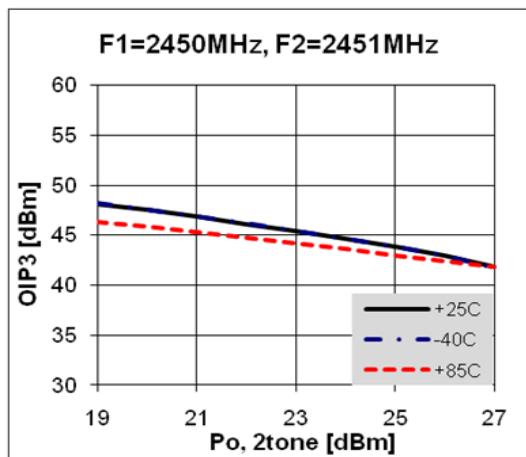
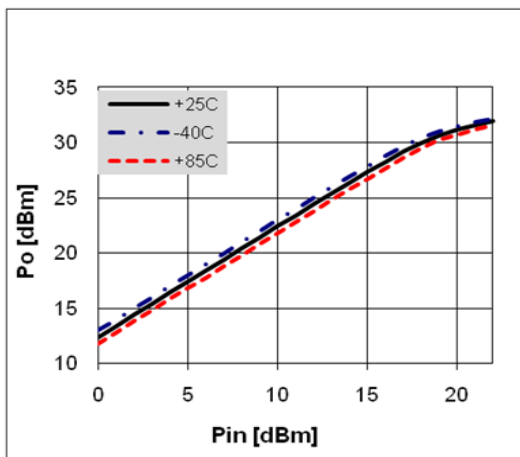
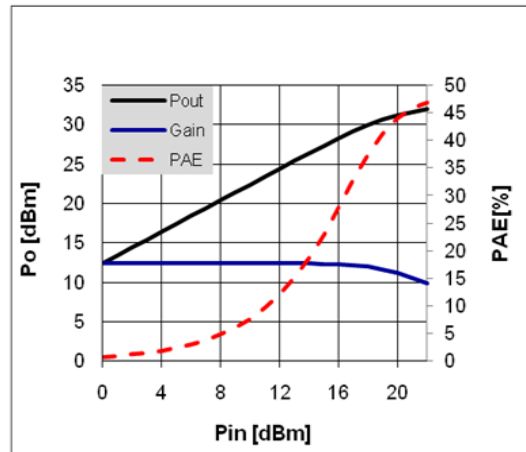
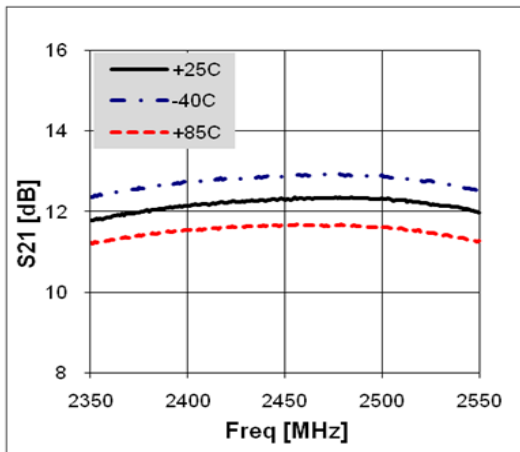
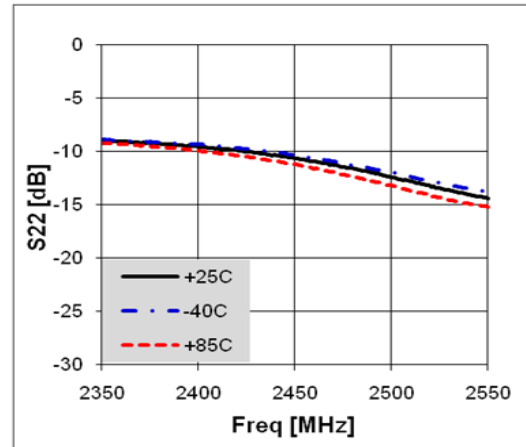
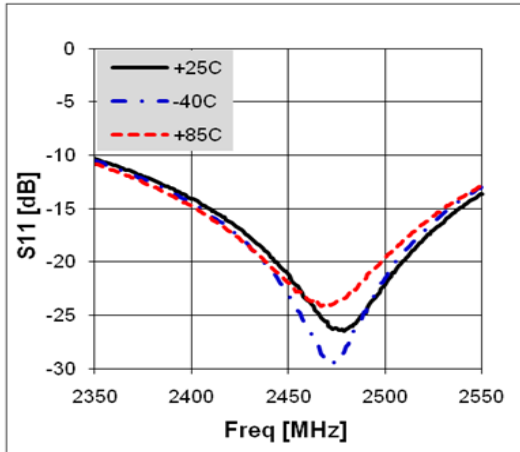

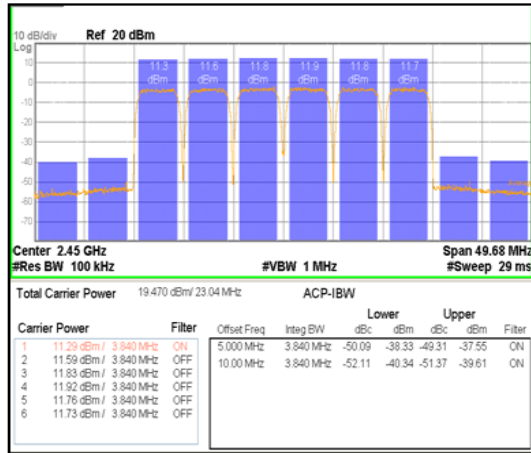
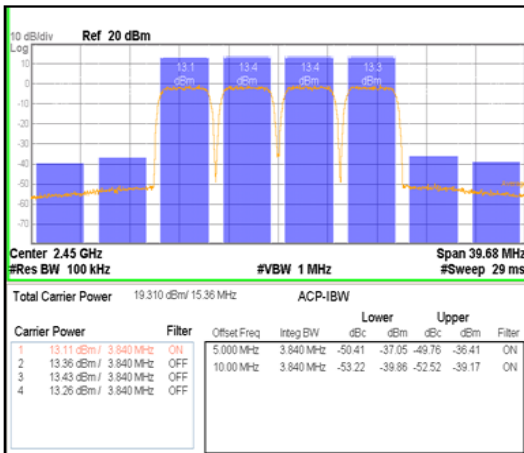
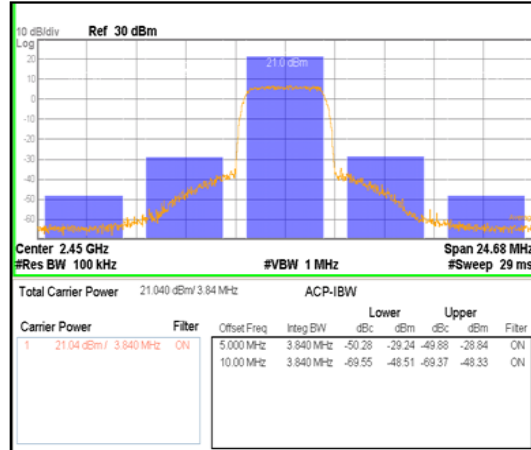
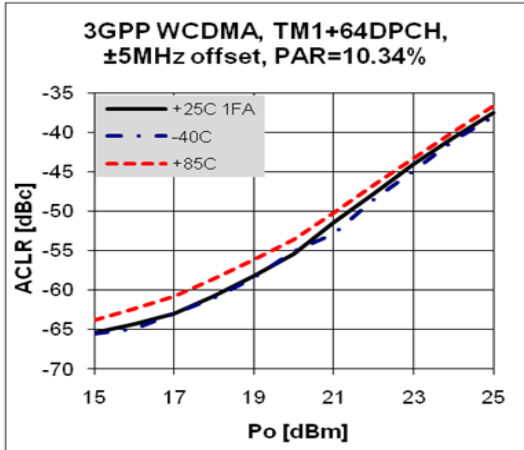

Application Circuit: 2600 MHz

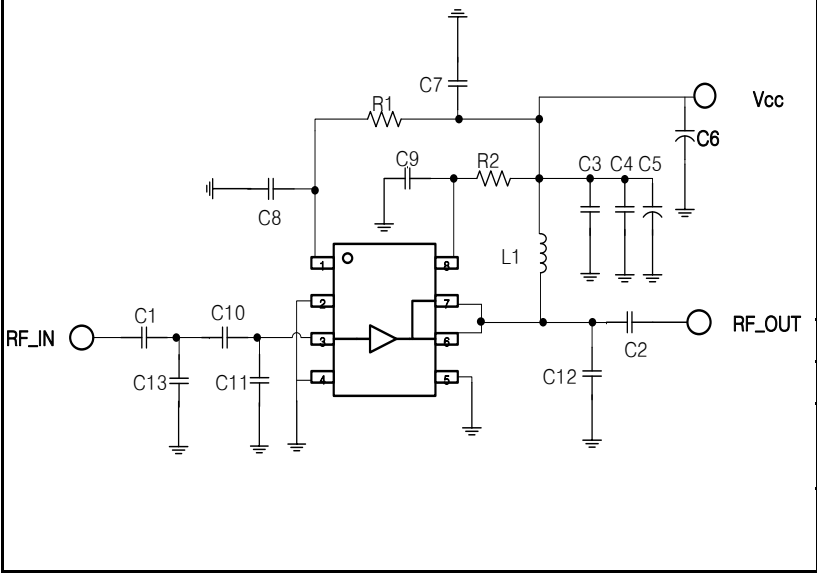
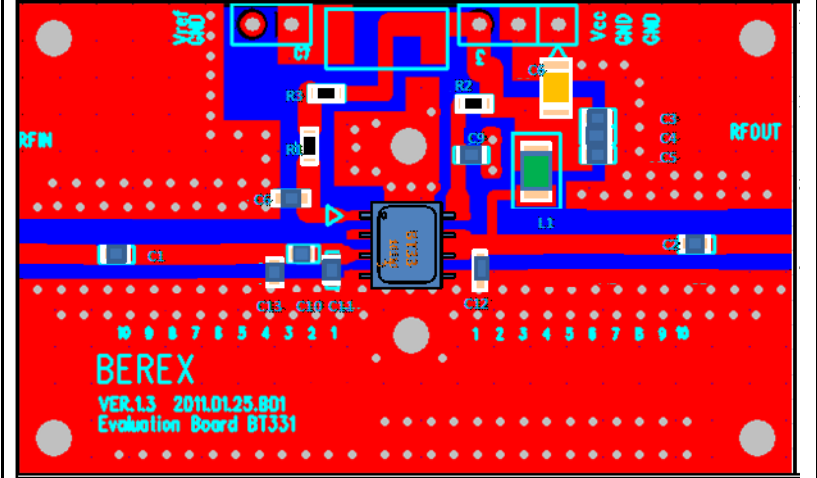
Schematic Diagram	BOM	Tolerance																																																																
	<table border="1"> <tr><td>C1</td><td>0603</td><td>100pF</td><td>±5%</td></tr> <tr><td>C2</td><td>0603</td><td>100pF</td><td>±5%</td></tr> <tr><td>C3</td><td>0603</td><td>100pF</td><td>±5%</td></tr> <tr><td>C4</td><td>0603</td><td>1nF</td><td>±5%</td></tr> <tr><td>C5</td><td>0603</td><td>1uF</td><td>±5%</td></tr> <tr><td>C6</td><td>1206</td><td>10uF</td><td>±20%</td></tr> <tr><td>C7</td><td></td><td>NC</td><td></td></tr> <tr><td>C8</td><td>0603</td><td>5pF</td><td>±5%</td></tr> <tr><td>C9</td><td>0603</td><td>2.5pF</td><td>±5%</td></tr> <tr><td>C10</td><td>0603</td><td>1pF</td><td>±5%</td></tr> <tr><td>C11</td><td>0603</td><td>0.5pF</td><td>±5%</td></tr> <tr><td>C12</td><td>0603</td><td>1.8pF</td><td>±5%</td></tr> <tr><td>C13</td><td>0603</td><td>1pF</td><td>±5%</td></tr> <tr><td>L1</td><td>1008</td><td>5.7nH</td><td>±5%</td></tr> <tr><td>R1</td><td>0603</td><td>5.6KΩ</td><td>±5%</td></tr> <tr><td>R2</td><td>0603</td><td>100Ω</td><td>±5%</td></tr> </table>	C1	0603	100pF	±5%	C2	0603	100pF	±5%	C3	0603	100pF	±5%	C4	0603	1nF	±5%	C5	0603	1uF	±5%	C6	1206	10uF	±20%	C7		NC		C8	0603	5pF	±5%	C9	0603	2.5pF	±5%	C10	0603	1pF	±5%	C11	0603	0.5pF	±5%	C12	0603	1.8pF	±5%	C13	0603	1pF	±5%	L1	1008	5.7nH	±5%	R1	0603	5.6KΩ	±5%	R2	0603	100Ω	±5%	
	C1	0603	100pF	±5%																																																														
	C2	0603	100pF	±5%																																																														
	C3	0603	100pF	±5%																																																														
	C4	0603	1nF	±5%																																																														
	C5	0603	1uF	±5%																																																														
	C6	1206	10uF	±20%																																																														
	C7		NC																																																															
	C8	0603	5pF	±5%																																																														
	C9	0603	2.5pF	±5%																																																														
	C10	0603	1pF	±5%																																																														
	C11	0603	0.5pF	±5%																																																														
	C12	0603	1.8pF	±5%																																																														
	C13	0603	1pF	±5%																																																														
L1	1008	5.7nH	±5%																																																															
R1	0603	5.6KΩ	±5%																																																															
R2	0603	100Ω	±5%																																																															
PCB Diagram	Notice																																																																	
	<ol style="list-style-type: none"> 1. PCB: 31mil thick FR4 2. Distance between the center of the shunt cap.(C13) and the input pin of BT331 _ 5.25 mm. 3. Distance between the center of the series cap.(C10) and the input pin of BT331 _ 2.8mm. 4. Distance between the center of the shunt cap.(C11) and the input pin of BT331 _ 1.5 mm. 5. Distance between the center of the shunt cap.(C12) and the output pin of BT331 _ 1.5 mm. 																																																																	

Typical Performance (Vc=5V, Icq=415mA, T=25°C)

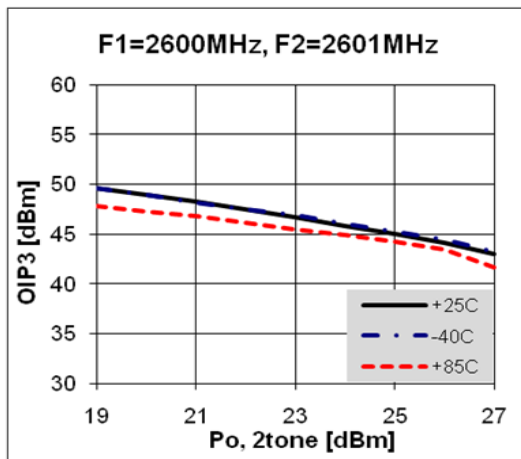
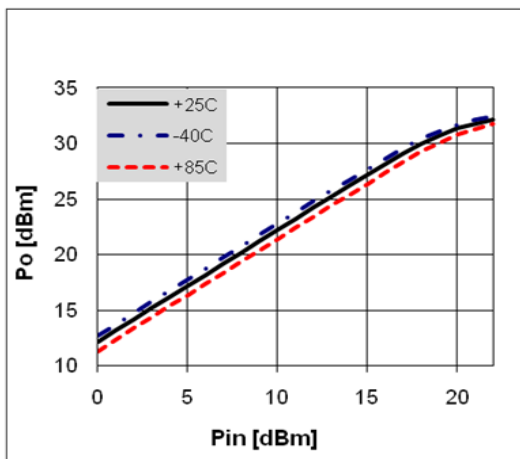
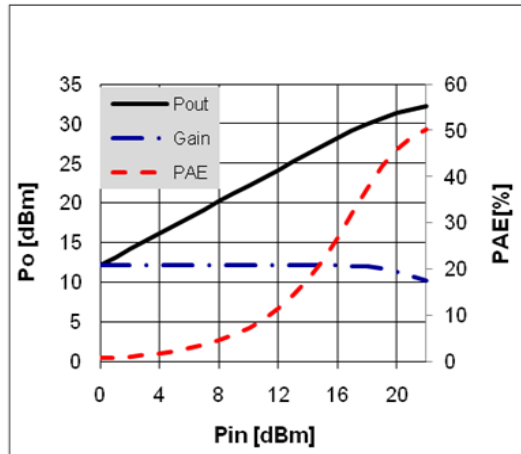
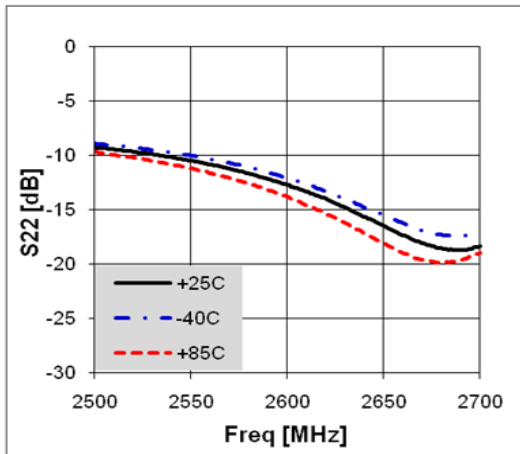
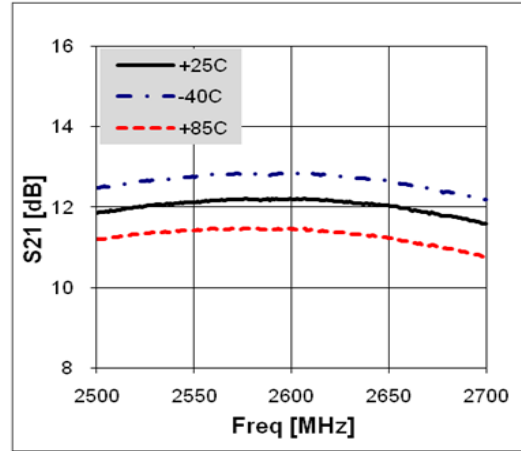
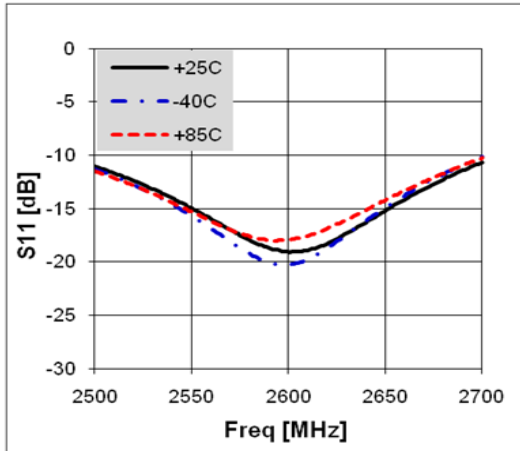

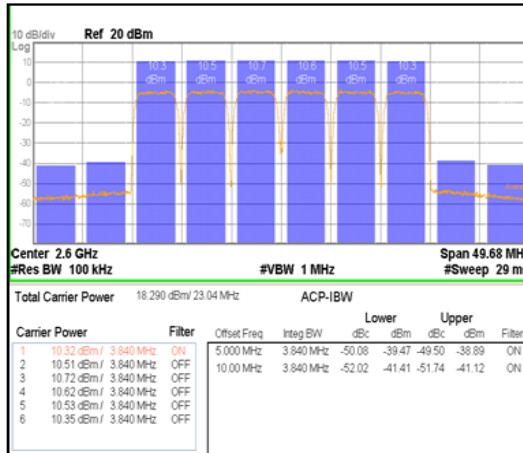
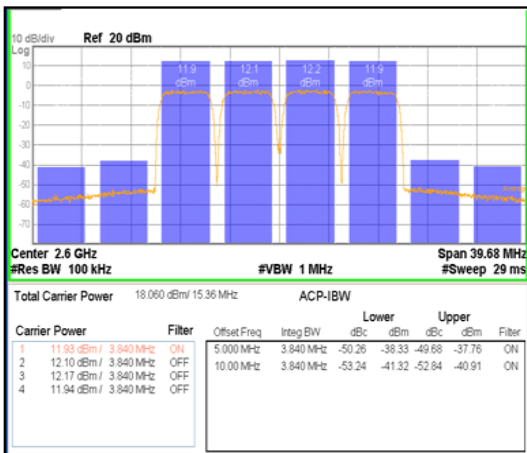
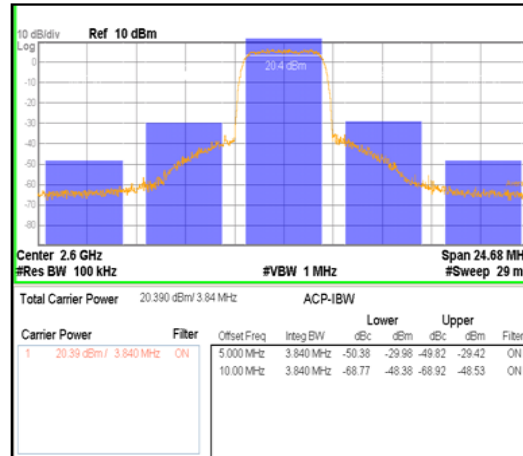
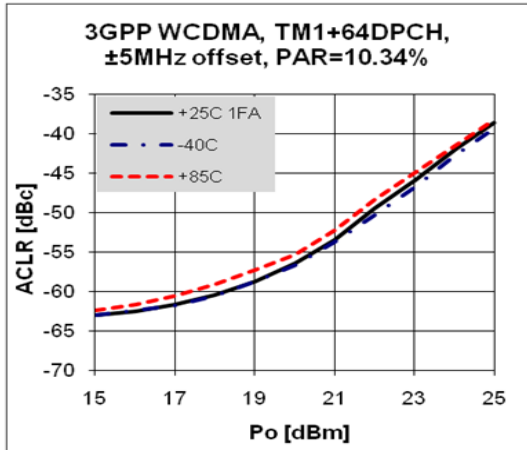

Typical Performance (Pout vs. Icc)
 (Vc=5V, Icq=415mA, T=25°C)

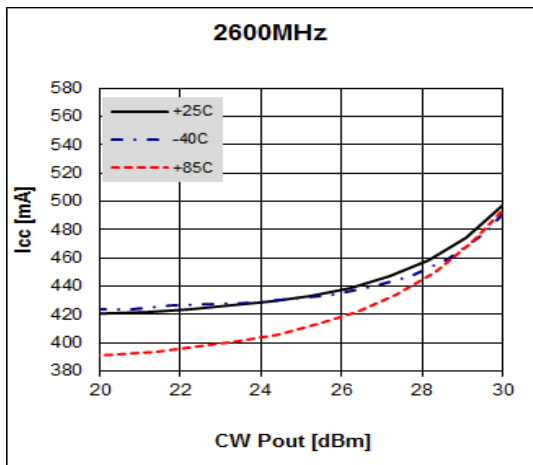
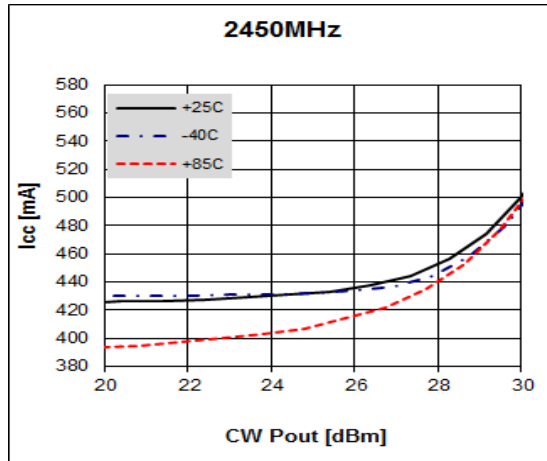
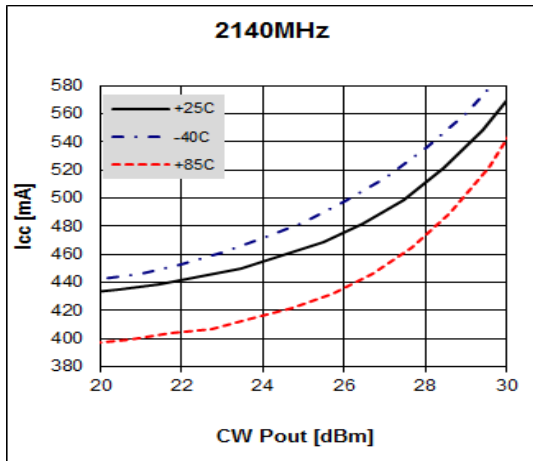
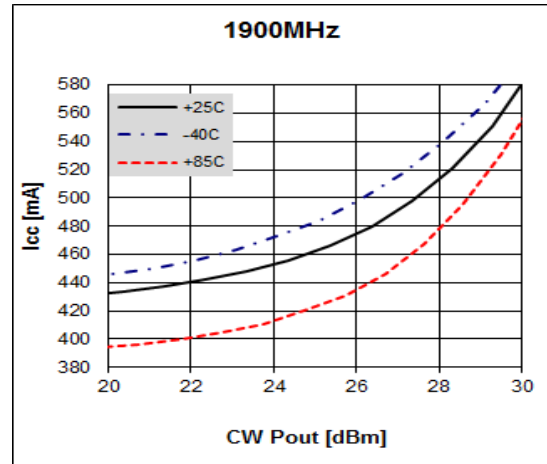
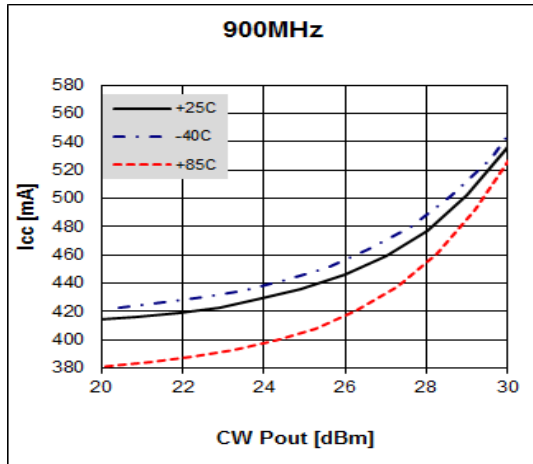

Package Outline Dimension

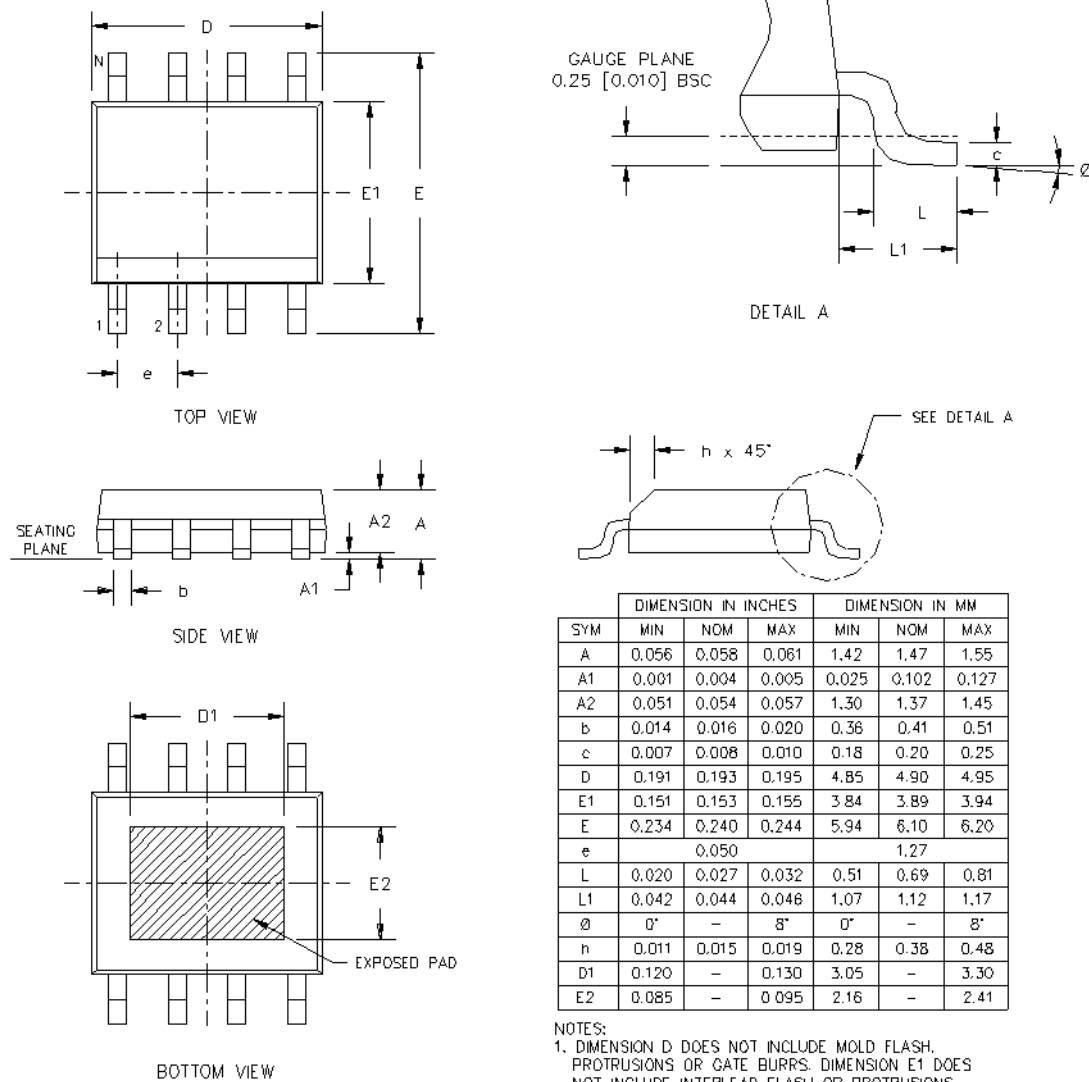

- NOTES:
1. DIMENSION D DOES NOT INCLUDE MOLD FLASH, PROTRUSIONS OR GATE BURRS. DIMENSION E1 DOES NOT INCLUDE INTERLEAD FLASH OR PROTRUSIONS.
 2. COPLANARITY APPLIES TO THE TERMINALS. COPLANARITY SHALL NOT EXCEED 0.003" [0.08 mm]
 3. BASED FROM JEDEC MS-012 VARIATION AA.

Suggested PCB Land Pattern and PAD Layout

PCB Land Pattern

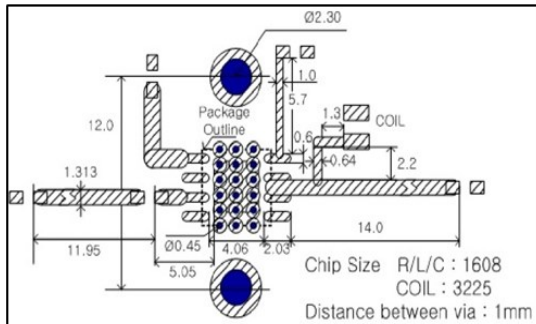

Note : All dimension are in millimeters

PCB lay out _on BeRex website

PCB Mounting

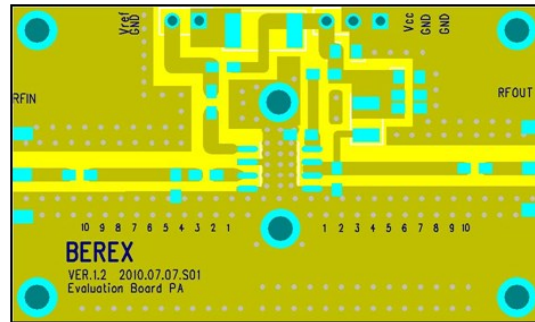

Package Marking

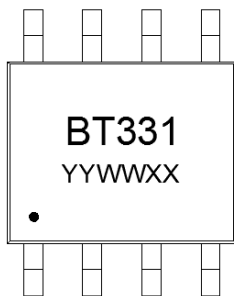

Pin 1

YY = Year, WW = Working Week,
XX = Wafer No.

Tape & Reel

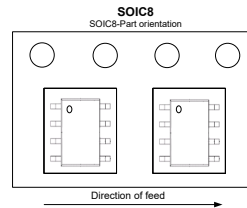

Packaging information:

Tape Width (mm): 12

Reel Size (inches): 7

Device Cavity Pitch (mm): 8

Devices Per Reel: 1000

Lead plating finish

100% Tin Matte finish

(All BeRex products undergoes a 1 hour, 150 degree C, Anneal bake to eliminate thin whisker growth concerns.)

MSL / ESD Rating

ESD Rating:	Class 0A
Value:	Passes <125V
Test:	Human Body Model (HBM)
Standard:	JEDEC Standard JS-001-2017
MSL Rating:	Level 3 at +260°C convection reflow
Standard:	JEDEC Standard J-STD-020



Proper ESD procedures should be followed when handling this device.

RoHS Compliance

This part is compliant with Restrictions on the Use of Certain Hazardous Substances in Electrical and Electronic Equipment (RoHS) Directive 2011/65/EU as amended by Directive 2015/863/EU.

This product also is compliant with a concentration of the Substances of Very High Concern (SVHC) candidate list which are contained in a quantity of less than 0.1%(w/w) in each components of a product and/or its packaging placed on the European Community market by the BeRex and Suppliers.

NATO CAGE code:

2	N	9	6	F
---	---	---	---	---