

The POEM Technology DASH (the former Hologram DASH)

Introduction The Dash v1.2 is a fully open source reference design and prototyping platform for developers to rapidly test and move applications to market. The Dash makes connectivity simple and enables embedded applications to access peripherals and sensors through an array of GPIO pins and serial interfaces. The on-board microcontrollers implement user and system functions separately for ease of development. Battery management includes charging and fuel gauge functions, making the Dash ideal for low power applications. Two versions are available, one is certified on all major carriers but Verizon. The second version is certified on all major carriers including Verizon. Please specify which version when ordering. Each DASH includes a sim card from Hologram to get you connected immediately. Hologram also offers a free developer account to test your design and develop your portal.

Microcontrollers

System Microcontroller The System microcontroller is Freescale's MKL17Z256VFM4 which features a 32-bit ARM Cortex-M0+ that runs at 48 MHz and has 256 kB Flash and 32 kB RAM. This microcontroller manages the u-blox modem as well as connections into Hologram's cloud.

- Open source System microcontroller firmware
- Datasheet for the MKL17Z256VFM4

User Microcontroller The User microcontroller is Freescale's MK22FN1M0AVLH12 which features a 32-bit ARM Cortex-M4 that runs at 120MHz and has 1MB Flash and 256kB RAM. This microcontroller exclusively hosts user programs that are fully compatible with Arduino APIs. (Note: although the firmware is fully Arduino-compatible, when loading Arduino libraries on the Dash, it is important to check the library for hardware-specific calls. In these cases these libraries will not be compatible with the Dash out of the box.)

- Open source User microcontroller firmware
- Datasheet for the MK22FN1M0AVLH12
- Reference sheet for the MK22FN1M0AVLH12

Open Source Hardware POEM Technology has taken over the manufacture of the DASH and we stand by the original Hologram commitment to provide open source hardware to developers seeking a field-tested and readily scalable reference design.

The Dash v1.2, as originally manufactured by Hologram, is certified by the OSHWA (Open Source Hardware Association) under identifier US000082. The design can be modified and adapted to any application (commercial or otherwise). POEM Technology's build of the DASH is identical but for markings.

[dash-hardware on github](#)

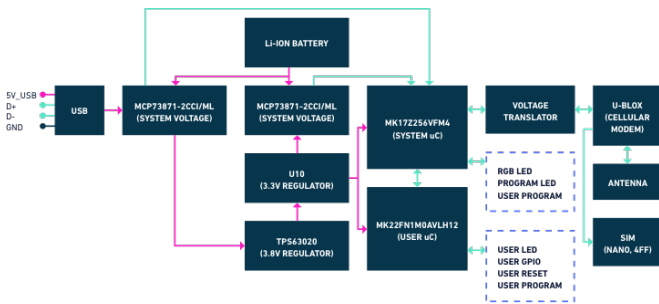

Block Diagram

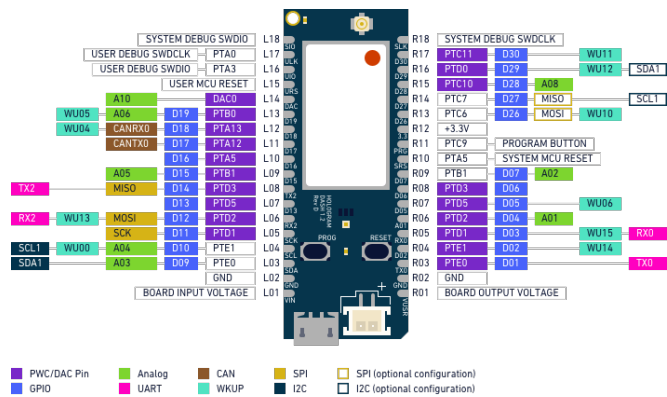

■ PWC/DAC Pin ■ Analog ■ CAN ■ SPI ■ SPI (optional configuration)
■ GPIO ■ UART ■ WKUP ■ I2C ■ I2C (optional configuration)

Pinout

Power Input/Output Characteristics The Dash v1.2 can be powered using the USB_5V, VBATT, or SystemVin pins. The Dash v1.2 can power other peripherals through the VSystem_User and 3.3V pins. Allowable minimum and maximum voltage and current for these power inputs and power outputs is listed below.

SYMBOL	DESCRIPTION	MIN	TYPICAL	MAX
USB_5V	USB 5V input	4.7	5V	5.25V / 2.1A
VBATT	Battery input	2.0V @ 0.1mA	4.2V	200mA
3.3V	3.3V output		3.3V	3.32V / 250mA
SystemVin	5V input	4.75V	5V	7V / 1.8A
VSystem_User	5V output			VSystem-.7* / 250mA**

*VSystem_User is a reference to the internal 5V power supply, protected by an input diode.

** Current draw by peripherals on this pin should be limited to 250mA to maintain normal operation of internal Dash components.

Peripherals and GPIO Peripherals and GPIO on the Dash v1.2 minimum and maximum voltages are listed below. The Dash user microcontroller works at 3.3V (i.e. 3.3V registers as a "1" for digital GPIO and analog input) and the digital pins are 5V tolerant whereas the analog pins are 4.1V tolerant.

FUNCTION	# OF PINS	INPUT/OUT	MIN	MAX
DIGITAL GPIO	25	BOTH	-0.3	5.5V
ADC	10	INPUT	-0.3	4.1V
DAC	1	OUTPUT	0	3.3V
I2C	2	BOTH	-0.3	5.5V
UART	2	BOTH	-0.3	5.5V
SPI	2*	BOTH	-0.3	5.5V
CAN	1	BOTH	-0.3	5.5V

*Denotes single SPI with 2 configurations

Power Management

DEEP SLEEP The Dash has three different power operating modes that are configurable via API:

- Normal (default): Both microcontrollers are running at standard clock rates (48MHz and 120MHz for the System and User microcontrollers, respectively) and the u-blox modem is on. The User modem can be configured for 120MHz, 100MHz, or 48MHz.
- Sleep: Instruction clock is paused and peripherals and interrupts remain active.
- deepSleep: Lowest possible power mode on the Dash. Most peripherals and interrupts are disabled, only select wake-up interrupts can wake from deepSleep (select I/O pins, alarm) when configured. The system microcontroller, user microcontroller, and u-blox modem can be placed into deepSleep independently. Current consumption in deepSleep is nominally 900µA.

BATTERY CHARGING Battery charging is automatically managed by the MCP73871-2CCI/ML IC.

The details for the MCP73871-2CCI/ML can be found on the [datasheet](#).

Radio Specifications The Dash v1.2 features the global band SARA-U201 or the global band SARA-R410M depending on 3G/2G or Cat-M/NB-IoT variant, respectively. Both of these modems are considered global band and work anywhere we have 2G/3G or Cat-M1 coverage, respectively.

The SARA-U201 modem supports a global list of 2G and 3G frequencies:

- 3G Bands:
 - ◇ Americas: Band 5 (850MHz), Band 2 (1900MHz)
 - ◇ Europe/Asia/Africa: Band 8 (900MHz), Band 1 (2100MHz)
- 2G Bands:
 - ◇ GSM - 850MHz
 - ◇ E-GSM - 900MHz
 - ◇ DCS - 1800 MHz
 - ◇ PCS - 1900 MHz

The SARA-R410M modem supports a global list of Cat-M1 and NB-IoT bands:

- 1, 2, 3, 4, 5, 8, 12, 13, 17, 18, 19, 20, 25, 26, 28 (and band 39 in M1-only)

These bands correspond to Uplink and Downlink frequencies in the following ranges (in MHz):

- 700, 800, 850, 900, 1700, 1800, 1900, 2100

The full list of bands and frequencies can be found in the [u-blox SARA datasheet](#).

Mechanical Dimensions

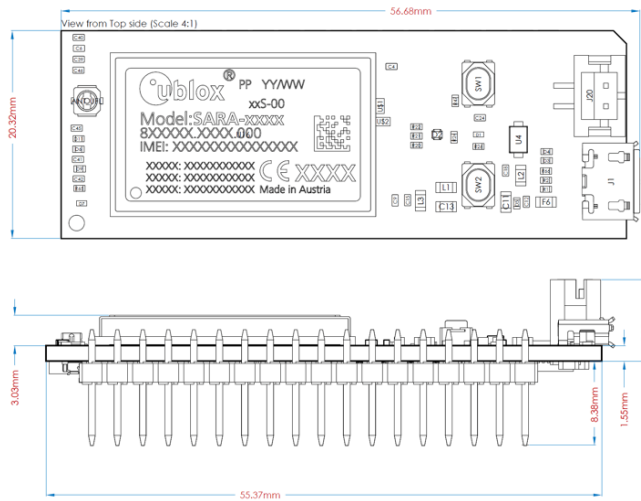

LEDs and Buttons The Dash includes 3 different LEDs and two different buttons:

- Reset Button: Resets the user microcontroller.
- Program Button: used to put Dash into programming mode.
- Program LED: flashes when the Dash is in programming mode.

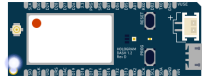

- User LED: full configurable by user programs using the Arduino IDE.

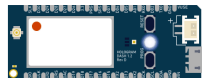

- RGB LED: configurable by user programs RGB LED.

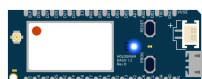
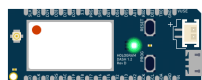
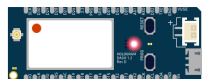

Antenna The Dash is made for ultimate flexibility and this extends to the antenna. The stock black antenna has the following characteristics:

- Size (main radiator): 2cm x 7cm
- Size (cable length): 10cm
- Connector: UFL
- Mounting: Adhesive 3M tape
- Temperature: -40C - +85C
 - ◇ VSWR 824MHz - 960MHz: < 3
 - ◇ 1710MHz - 2170MHz: < 3
- Impedance: 50ohm



Ordering Information

POEM Technology, LLC

100 Terminal Dr.

Plainview, NY 11803

sales@poemtechnology.com

Read more about configuring both User and RGB LEDs in our [Dash API reference](#).