

Build Your Own Clone Phase Royal Kit Instructions



Warranty:

BYOC, LLC guarantees that your kit will be complete and that all parts and components will arrive as described, functioning and free of defect. Soldering, clipping, cutting, stripping, or using any of the components in any way voids this guarantee. BYOC, LLC guarantees that the instructions for your kit will be free of any major errors that would cause you to permanently damage any components in your kit, but does not guarantee that the instructions will be free of typos or minor errors. BYOC, LLC does not warranty the completed pedal as a whole functioning unit nor do we warranty any of the individual parts once they have been used. If you have a component that is used, but feel it was defective prior to you using it, we reserve the right to determine whether or not the component was faulty upon arrival. Please direct all warranty issues to:

sales@buildyourownclone.com This would include any missing parts issues.

Return:

BYOC, LLC accepts returns and exchanges on all products for any reason, as long as they are unused. We do not accept partial kit returns. Returns and exchanges are for the full purchase price less the cost of shipping and/or any promotional pricing. Return shipping is the customer's responsibility. This responsibility not only includes the cost of shipping, but accountability of delivery as well. Please contact sales@buildyourownclone.com to receive a return authorization before mailing.

Tech Support:

BYOC, LLC makes no promises or guarantees that you will successfully complete your kit in a satisfactory manner. Nor does BYOC, LLC promise or guarantee that you will receive any technical support. Purchasing a product from BYOC, LLC does not entitle you to any amount of technical support. BYOC, LLC does not promise or guarantee that any technical support you may receive will be able to resolve any or all issues you may be experiencing.

That being said, we will do our best to help you as much as we can. Our philosophy at BYOC is that we will help you only as much as you are willing to help yourself. We have a wonderful and friendly DIY discussion forum with an entire section devoted to the technical support and modifications of BYOC kits.

www.buildyourownclone.com/board

When posting a tech support thread on the BYOC forum, please post it in the correct lounge, and please title your thread appropriately. If everyone titles their threads "HELP!", then it makes it impossible for the people who are helping you to keep track of your progress. A very brief description of your specific problem will do. It will also make it easier to see if someone else is having or has had the same problem as you. The question you are about to ask may already be answered. Here are a list of things that you should include in the body of your tech support thread:

1. A detailed explanation of what the problem is. (not just, "It doesn't work, help")
2. Pic of the top side of your PCB.
3. Pic of the underside of your PCB.
4. Pic that clearly shows your footswitch/jack wiring and the wires going to the PCB
5. A pic that clearly shows your wiring going from the PCB to the pots and any other switches (only if your kit has non-PC mounted pots and switches)
6. Is bypass working?
7. Does the LED come on?
8. If you answer yes to 6 and 7, what does the pedal do when it is "on"?
9. Battery or adapter. (if battery, is it good? If adapter, what type?)

Also, please only post pics that are in focus. You're only wasting both parties' time if you post out of focus, low res pics from your cell phone.

Revision Notes:

Rev 1.0 There are no known errors.

Rev 1.1: Replaced 2 '47n' capacitors with electrolytic capacitors. **See page 18 for an explanation.**

Copyrights:

All material in this document is copyrighted 2009 by BYOC, LLC



**PHASE ROYAL
KIT
INSTRUCTION INDEX**

Before You Get Started.....page 4 - 6

Parts Checklist.....page 7 - 8

Populating the Circuit Board.....page 9 - 21

Main PCB Assembly.....page 22 - 24

Wiring.....page 25 - 28

Installing the IC's and Finishing Up.....page 29

Operation Overview.....page 30 - 31

Schematic.....page 32 - 33

Before you get started....

There are a two things about this particular build that you should be aware of so that you don't get confused when you compare the parts list to the layout on the PCB.

1. There is a 2.2M resistor that will be inserted into the PCB so that it is standing on end rather than laying flat like all the other resistors. The PCB will have a "2M2" printed on it with an arrow pointing to the eyelets on the PCB where this resistor will go. (see page 10 - 11 for instructions)
2. There is an 8 pin dual op amp that goes on the bottom of the PCB.

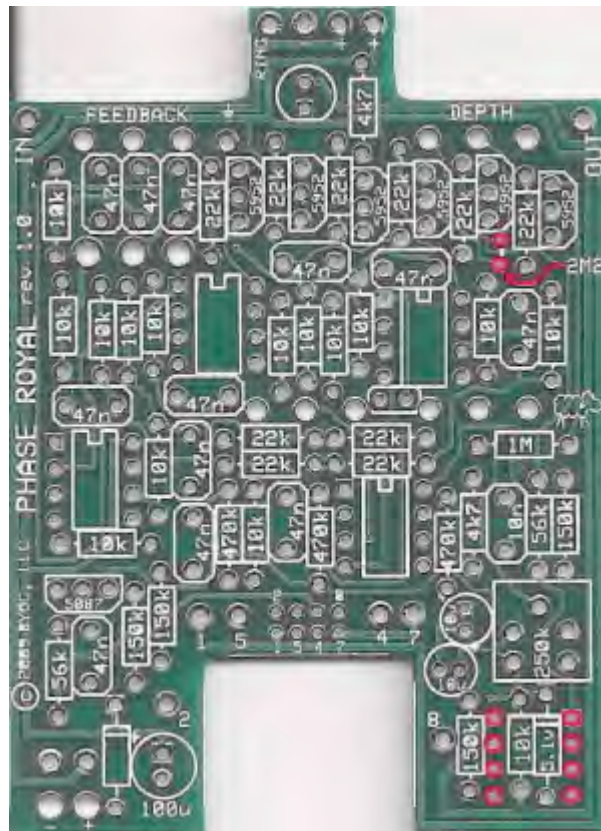

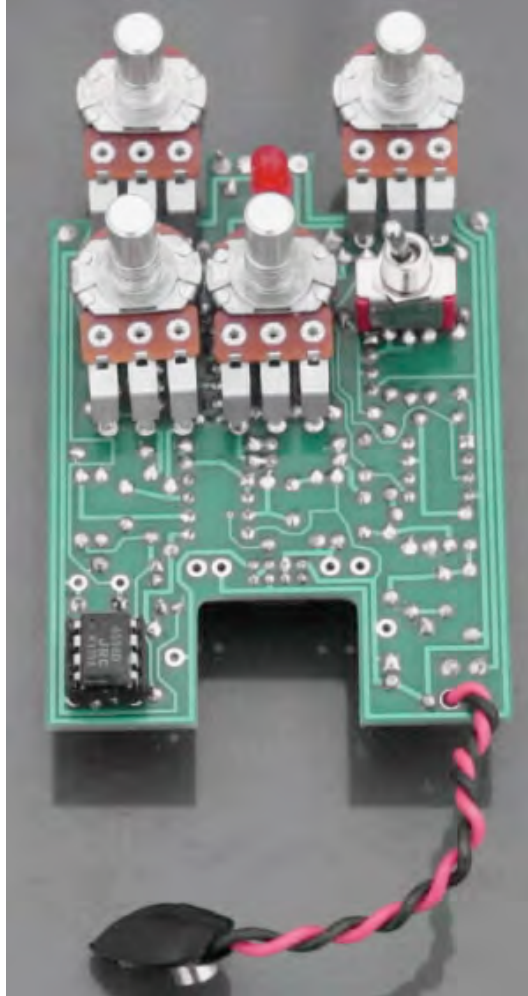
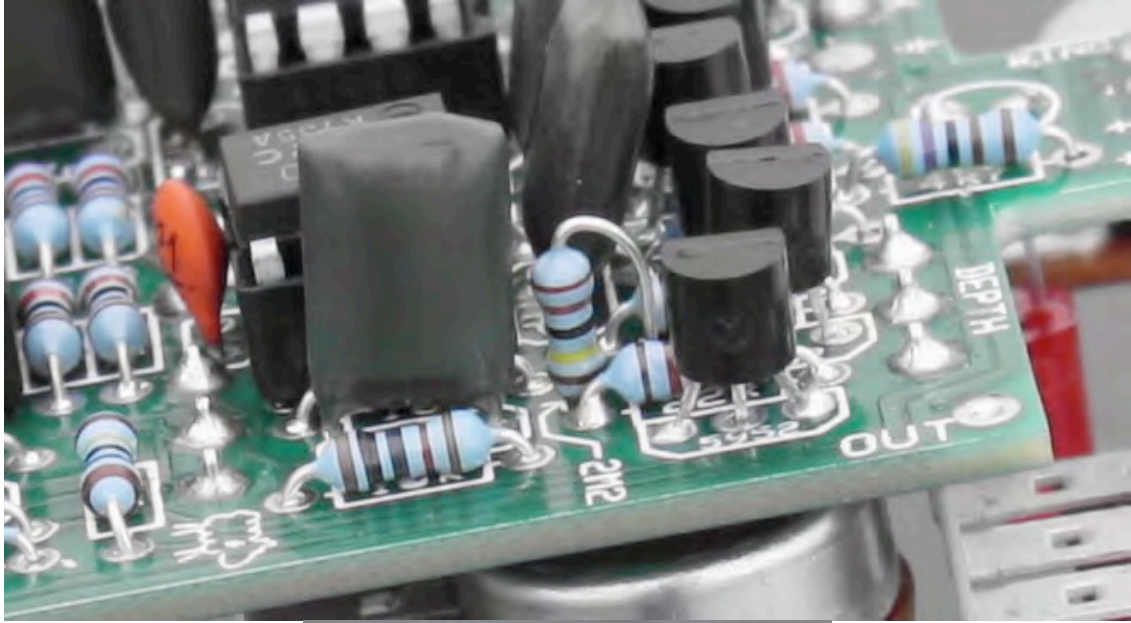

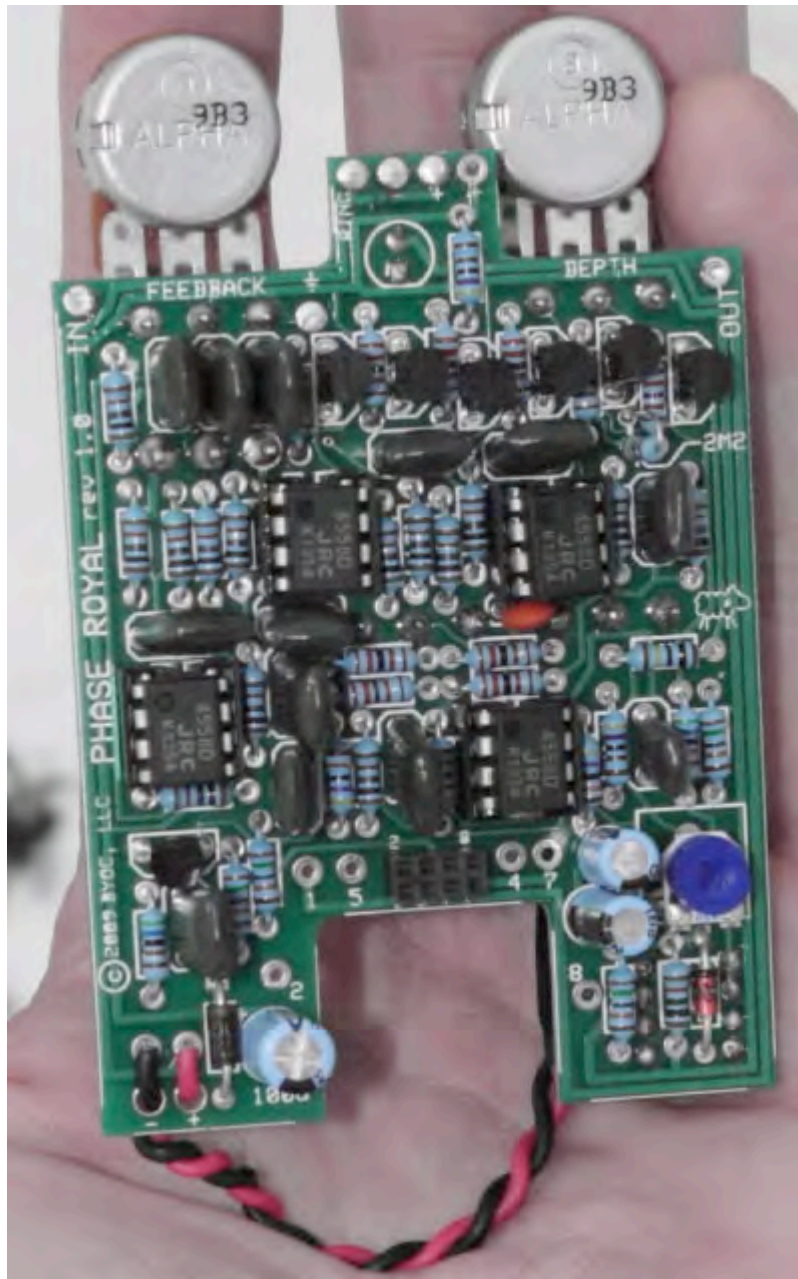

This is a picture of the top side of the completed PCB assembly to be used as a reference throughout the build. NOTE: There is a footswitch socket between eyelets “5” and “4” that is not part of the standard kit.

Parts Checklist for BYOC Phase Royal

Resistors:

- 2 - 4k7 (yellow/purple/black/brown/brown)
- 15 - 10k (brown/black/black/red/brown)
- 10 - 22k (red/red/black/red/brown)
- 2 - 56k (green/blue/black/red/brown)
- 4 - 150k (brown/green/black/orange/brown)
- 3 - 470k (yellow/purple/black/orange/brown)
- 1 - 1M (brown/black/black/yellow/brown)
- 1 - 2.2M (red/red/black/yellow/brown)

Capacitors:

- 1 - 220pf ceramic disc (small orange labelled 221)
- 1 - 10n or .01 μ film (103)
- 10 - 47n or .047 μ film (473)
- 1 - 4.7u aluminum electrolytic
- 3 - 10 μ f aluminum electrolytic
- 1 - 100 μ f aluminum electrolytic

Diodes:

- 1 - 1N4001 (black plastic with silver stripe)
- 1 - 1N4733 5.1v Zener (orange glass with black stripe)

Transistors:

- 1 - 2N5087
- 6 - 2N5952

IC's:

- 5 - 4558, TL072 or other dual op amp
- 5 - 8 pin socket

Trimpots:

- 1 - 250k

Potentiometers: Be sure to snap off the small tab on the side of each panel mounted pot.

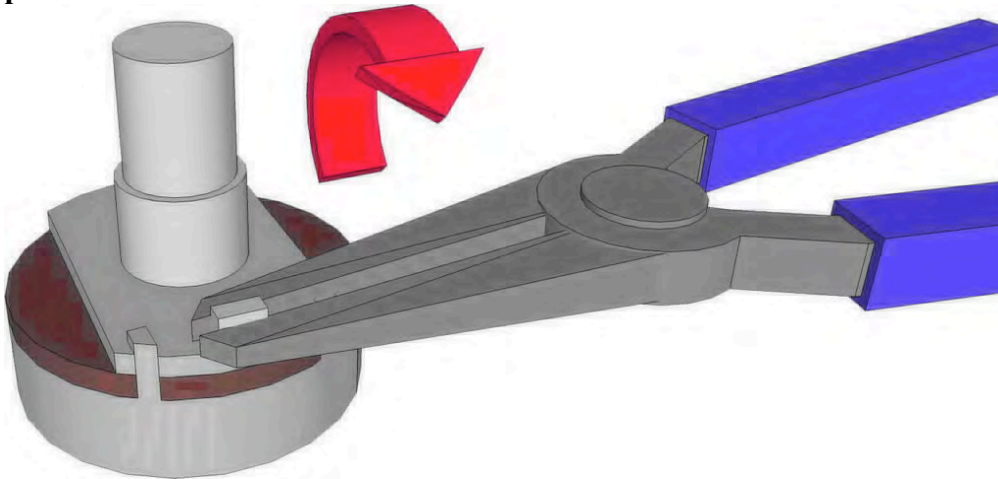

1 - B100k

- linear (Depth knob)
- 1 - B100k linear (Depth knob)
- 1 - C500k reverse audio (Speed knob)
- 2 - B10k audio (Mix & Resonance knobs)

Hardware:

- 1 - drilled enclosure w/ 4 screws
- 1 - byoc phase royalPCB
- 1 - SPDT toggle switch
- 1 - 3PDT footswitch
- 4 - knobs
- 1 - AC adaptor jack
- 1 - 1/4" mono jack
- 1 - 1/4" stereo jack
- 1 - red LED
- 1 - battery snap
- 4 - bumpers
- hook-up wire

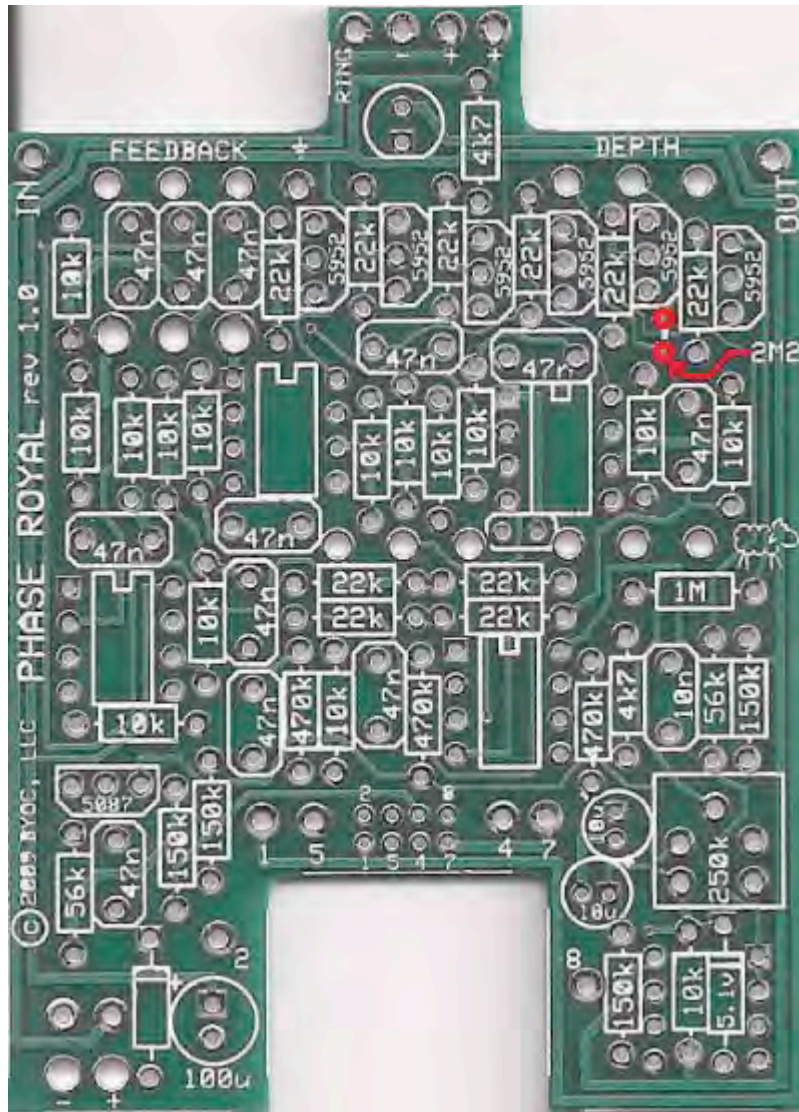

Step 3: Add the 2.2M(2M2) resistor. Stand it on end. Insert one end into one of the eyelets highlighted in red. Bend the other end and insert it into the other eyelet highlighted in red. See pictures below for examples.

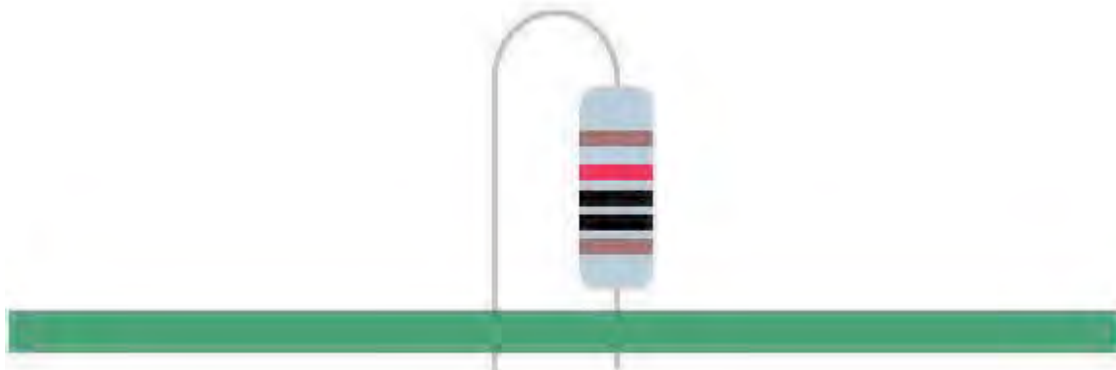

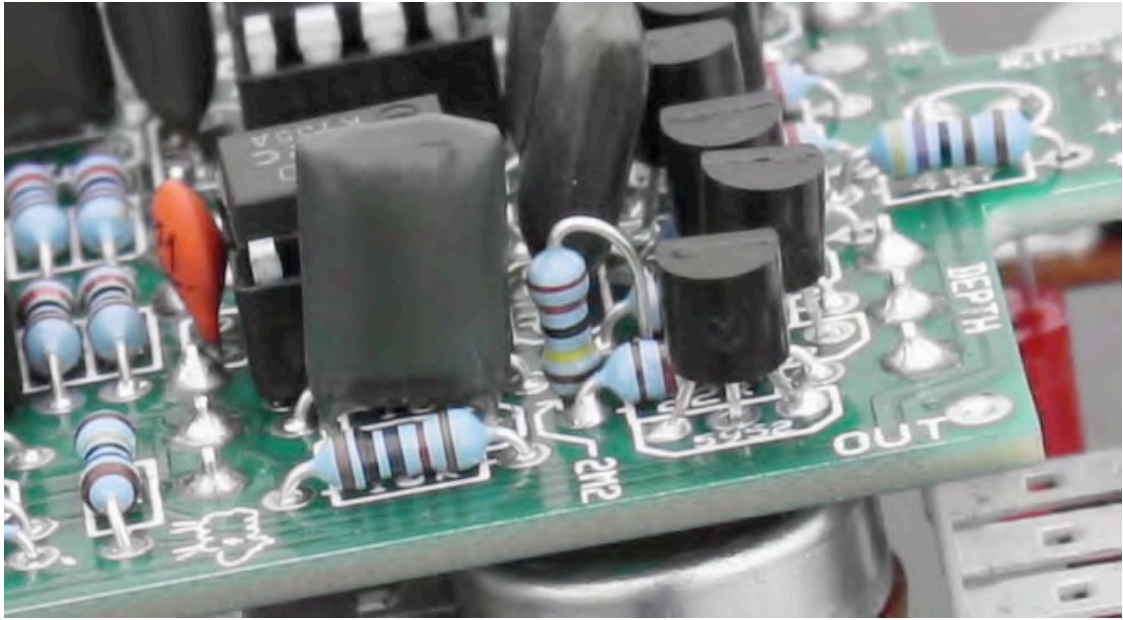

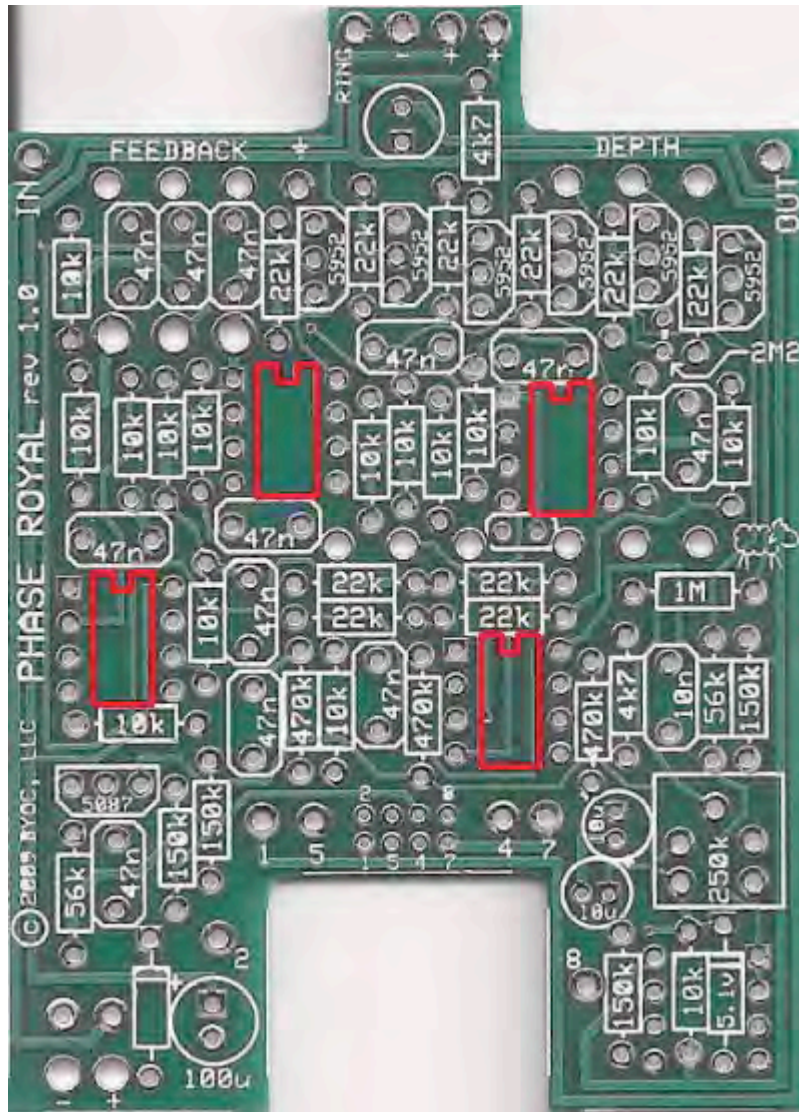

STEP 4: Add the 8 pin IC sockets. **ONLY SOLDER THE SOCKET! NOT THE ACTUAL IC!** These are sockets. The sockets get soldered to the PCB. The ICs get inserted into the sockets. The actual IC chips themselves, never get soldered. You will insert the ICs into the sockets after the entire pedal has been built.

Only add the 4 sockets that go on the top of the PCB. Do not add the 5th socket that goes on the bottom yet. Orient the sockets so that the side with the notch matches up with the notch on the PCB layout.

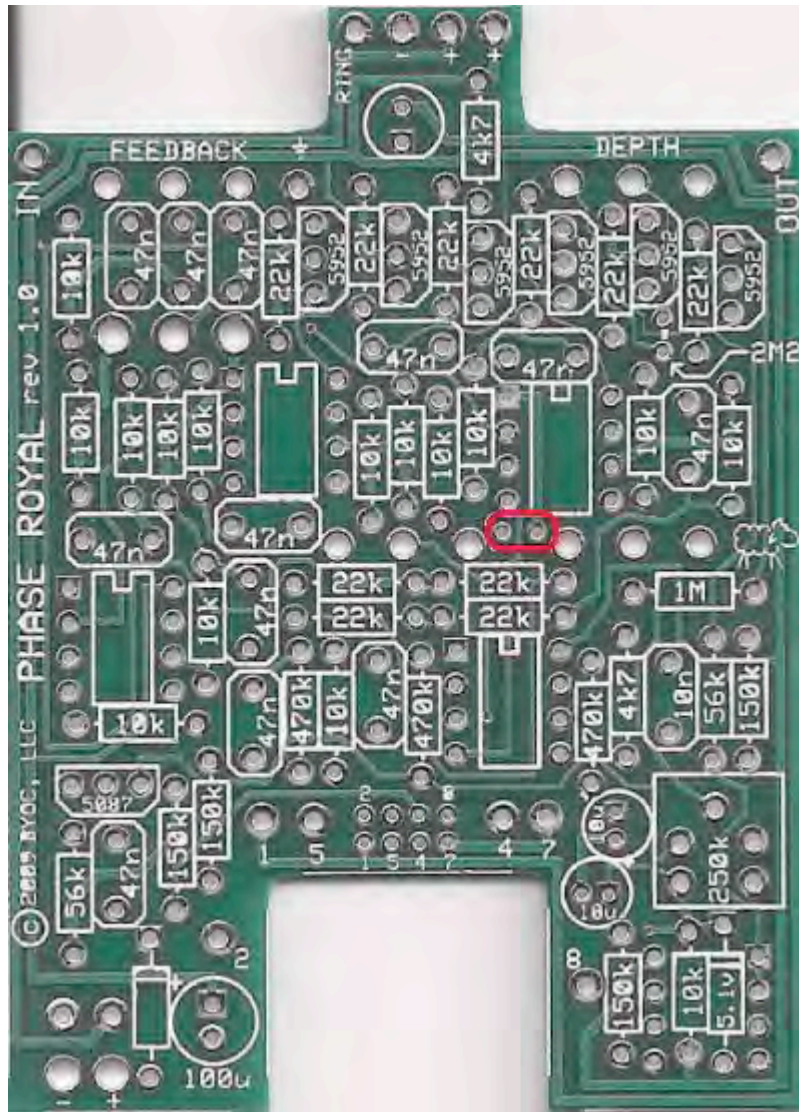

STEP 5: Add the ceramic disc capacitor. This component is non-polarized, so you can insert it into the PCB either way.

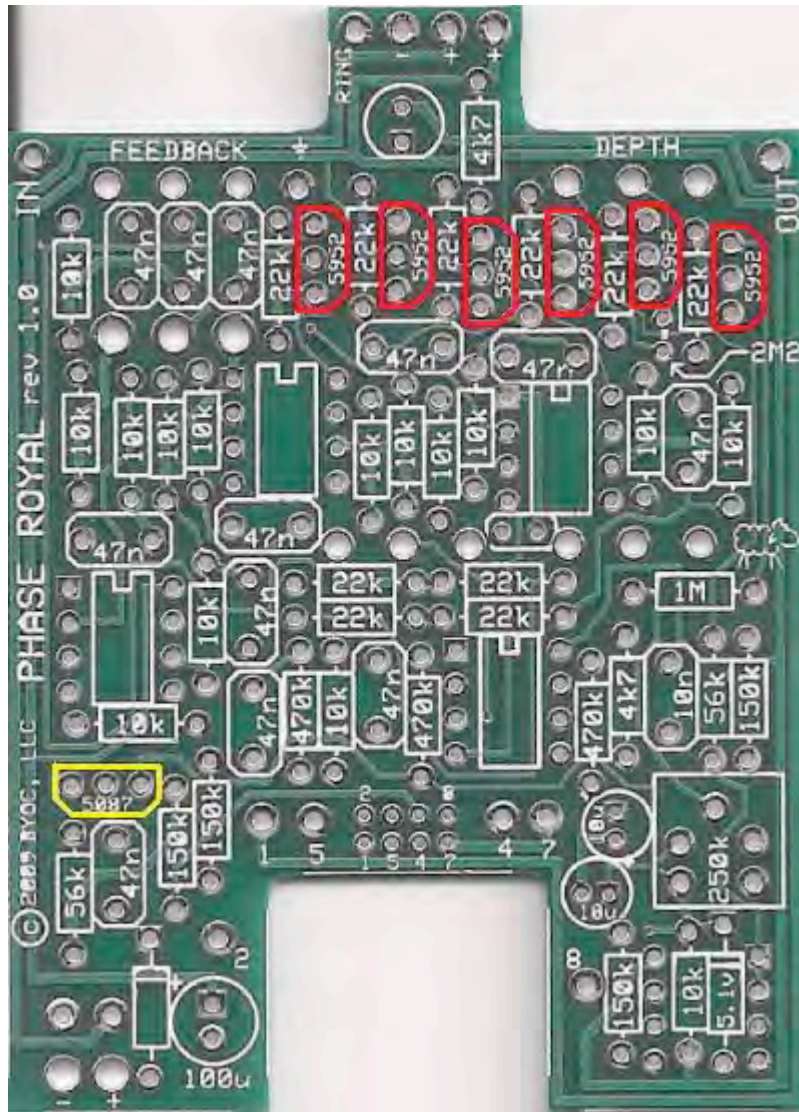

Step 6: Add the Transistors. The six 2N5952 JFETs go in the spot highlighted in red. The 2N5087 goes in the spot highlighted in yellow. Be sure to orient the transistors so that the flat side of the transistor body matches up with the flat side on the PCB layout.

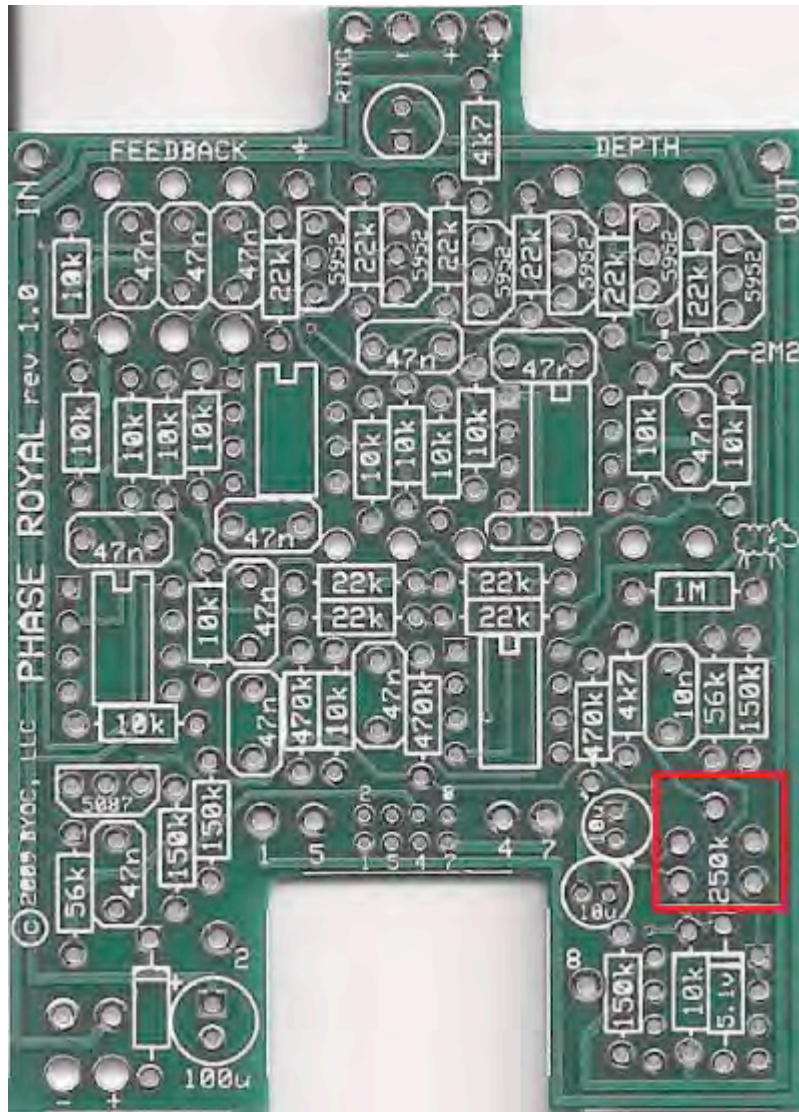

Step 7: Add the 250k trimpot. Note that the PCB has 5 holes, but the actual trimpot itself will only have 3 leads. This is so that the PCB can accommodate a variety of different makes and model of trimpots. There should only be one way in which the trimpot provided with your kit fits easily into the PCB

ADJUSTING THE TRIMPOT:

Once you have completed your build(not before), you will need to adjust the trimpot before the phaser will actually work. There is no specific voltage that you should try to set it for. Simply use your ears! You are setting it so that the phaser has the fullest sweep that sounds as close to the way you want it to sound. There is actually a relatively large range on the trimpot that will give you working phase shifting, and much of it will sound very good. But you'll have to use your ears if you want to dial in the “script” tone. If that doesn't make sense to you, just adjust the trimpot till you get the deepest, lushest phase tone. Start by setting the knobs as follows:

1. Depth- full turn clockwise
2. Resonance - full turn counter clockwise

3. Rate - 2 o'clock
4. Mix - noon
5. Phase stage switch - 4 (to the right)

Plug into your guitar and amp. Make sure bypass works. Make sure you have power to the pedal and the LED comes on. You should hear a clean unaffected guitar signal. Now turn the trimpot until you hear the phase kick in. Fine tune to taste.

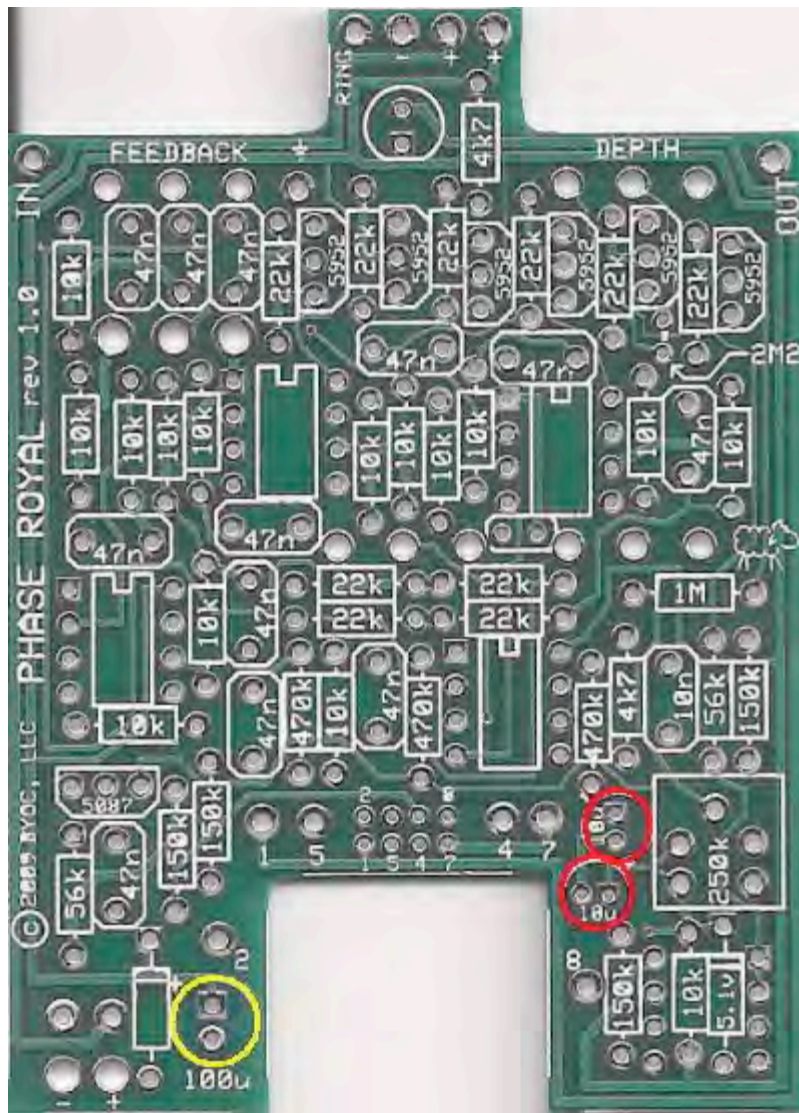

STEP 8: Add the aluminum electrolytic capacitors. These are polarized. The positive end will have a longer lead and should go in the square solder pad. The negative end will have a shorter lead with a black strip running down the body of the capacitor.

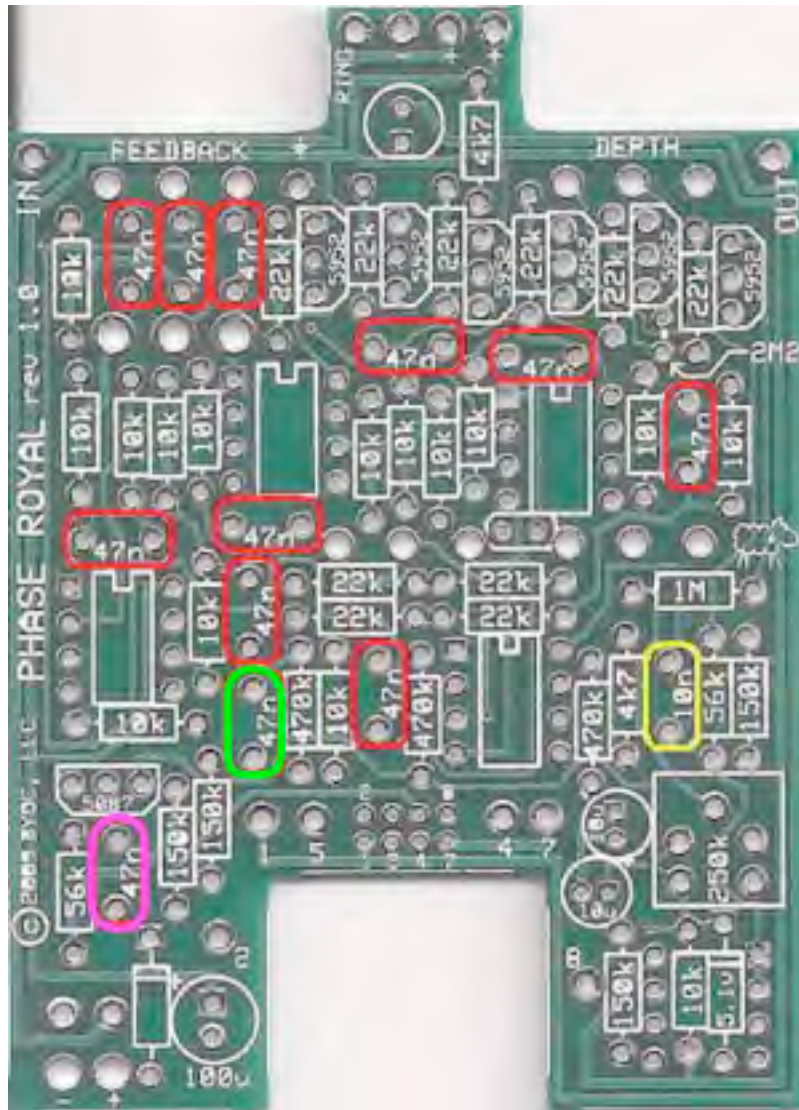

Step 9: Add the film capacitors. These are not polarized and can be inserted into the PCB either way. The 47n (.047 μ) caps are highlighted in red. The 10n (.01 μ) cap is highlighted in yellow. **The Capacitor highlighted in GREEN is the 4.7u electrolytic.**
The Capacitor highlighted in PINK is the 10u electrolytic.

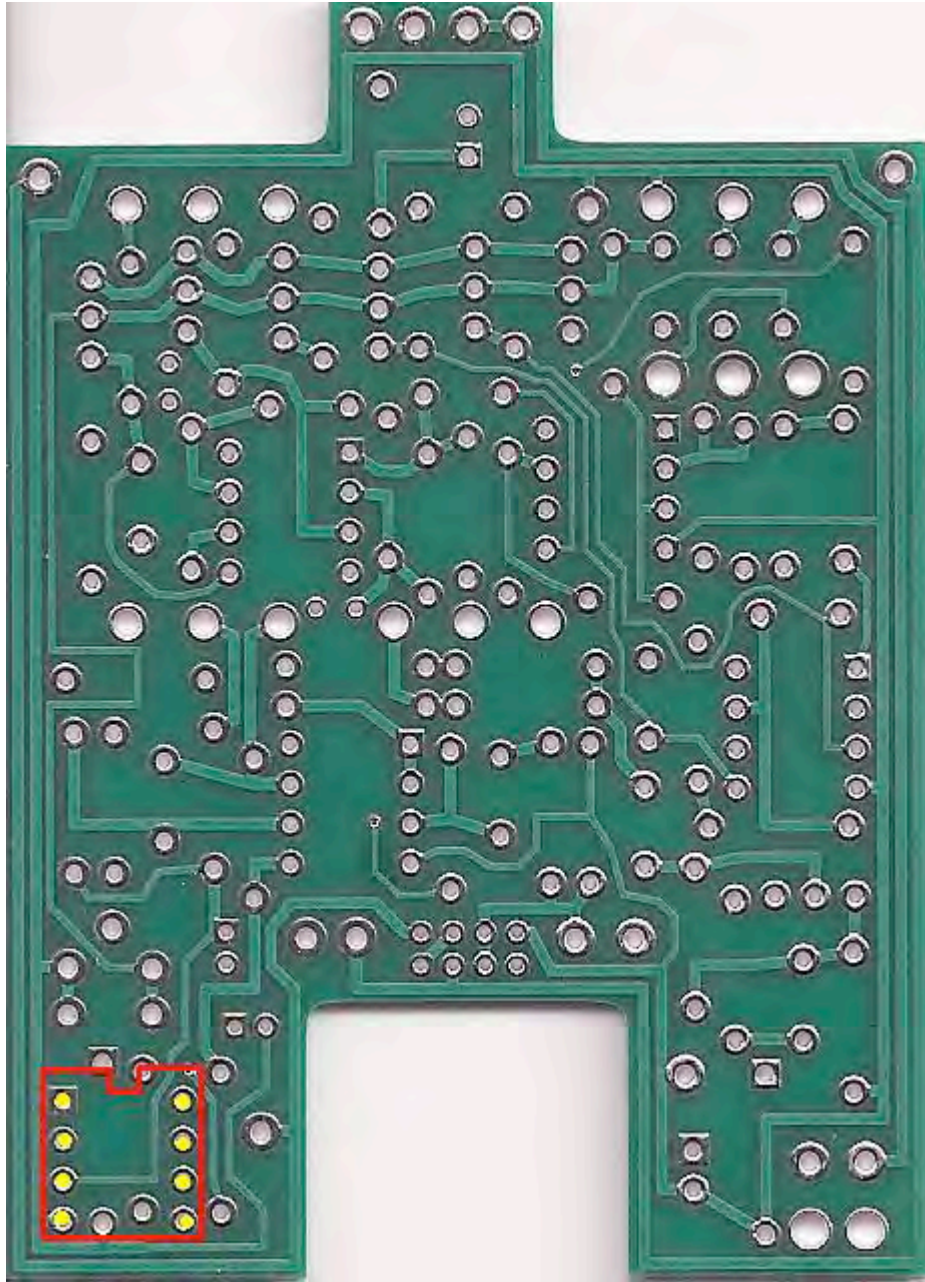

Step 10: Add the remaining IC socket to the bottom solder side of the PCB. Be sure to orient the socket so that the notch matches the outline in the diagram above.

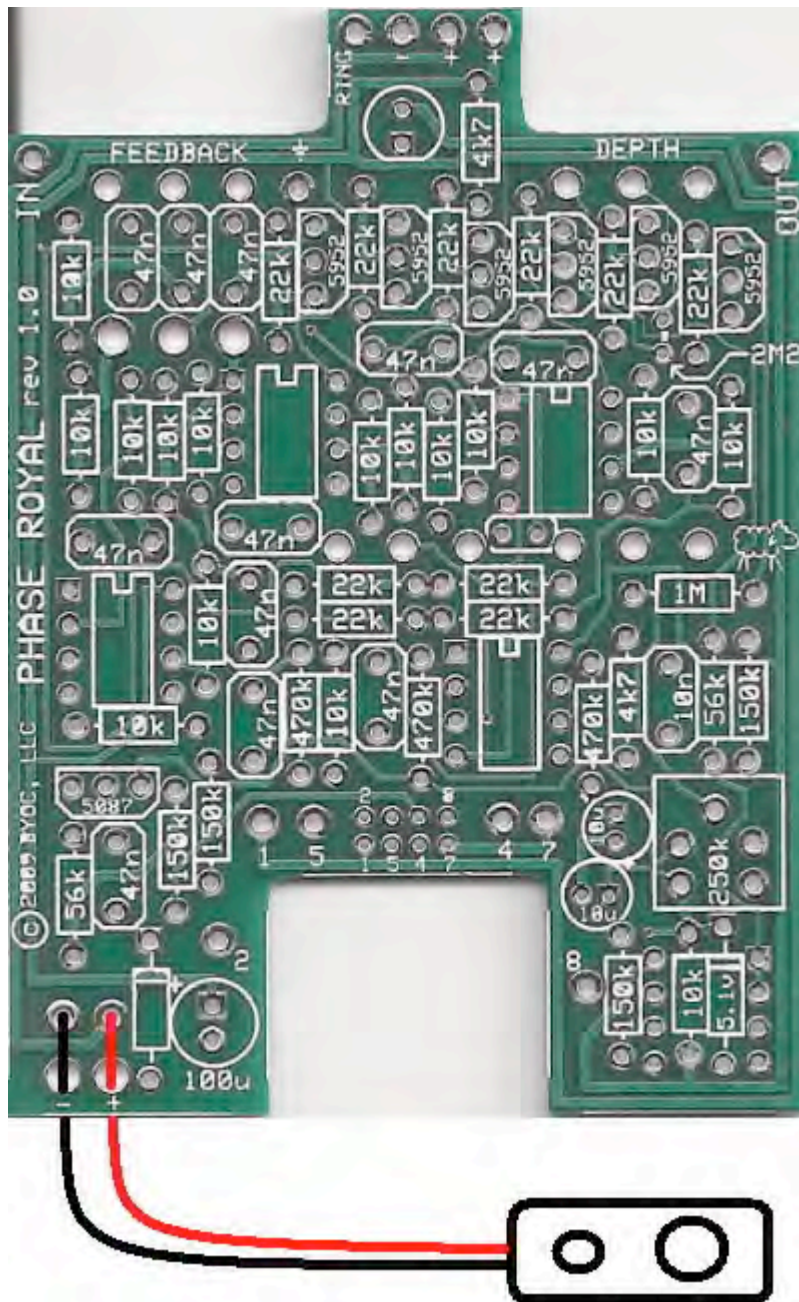

Step 11: Add the battery snap. Thread the solder ends of the battery snap into the strain relief holes from the bottom solderside of the PCB and out through the top. Insert the solder ends of the battery snap wires into the topside of their respective solder pads. Solder on the bottom side of the PCB. Remember the red wire goes in the “+” hole and the black wire goes in the “-” hole.

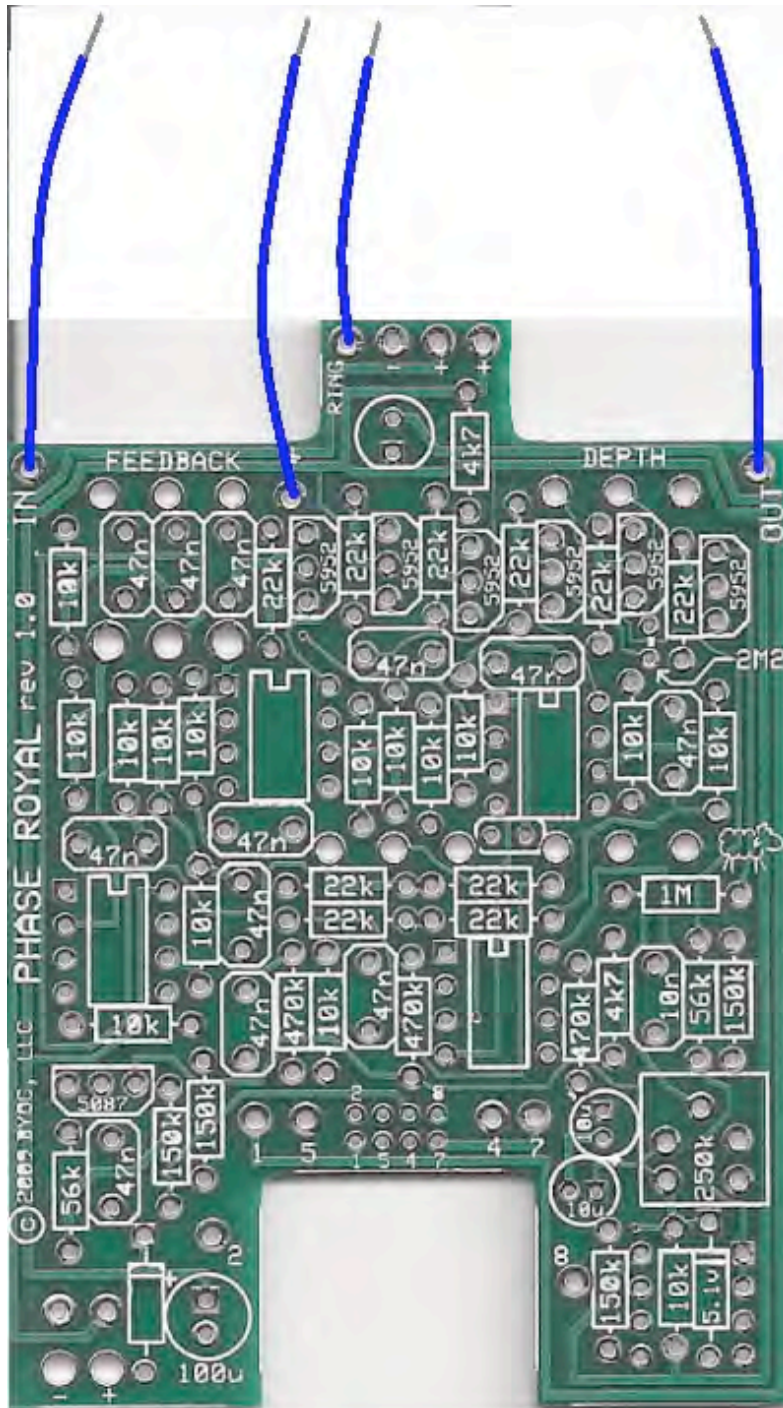

Step 12: Add wires to the IN, OUT, Ground, and RING eyelets. Start by cutting four 2.5" pieces of wire and one 1.5" piece of wire. Strip 1/4" off each end and tin the ends. Tinning means to apply some solder to the stripped ends of the wires. This keeps the strands from fraying and primes the wire for soldering. Solder a 2.5" piece of wire to each of the IN, OUT, and Ground eyelets on the PCB. Solder the 1.5" piece of wire to the RING eyelet on the PCB. Load the wires in from the top and solder on the bottom of the PCB.

Main PCB Assembly

Step 1: Mount the DC adaptor jack to the enclosure.

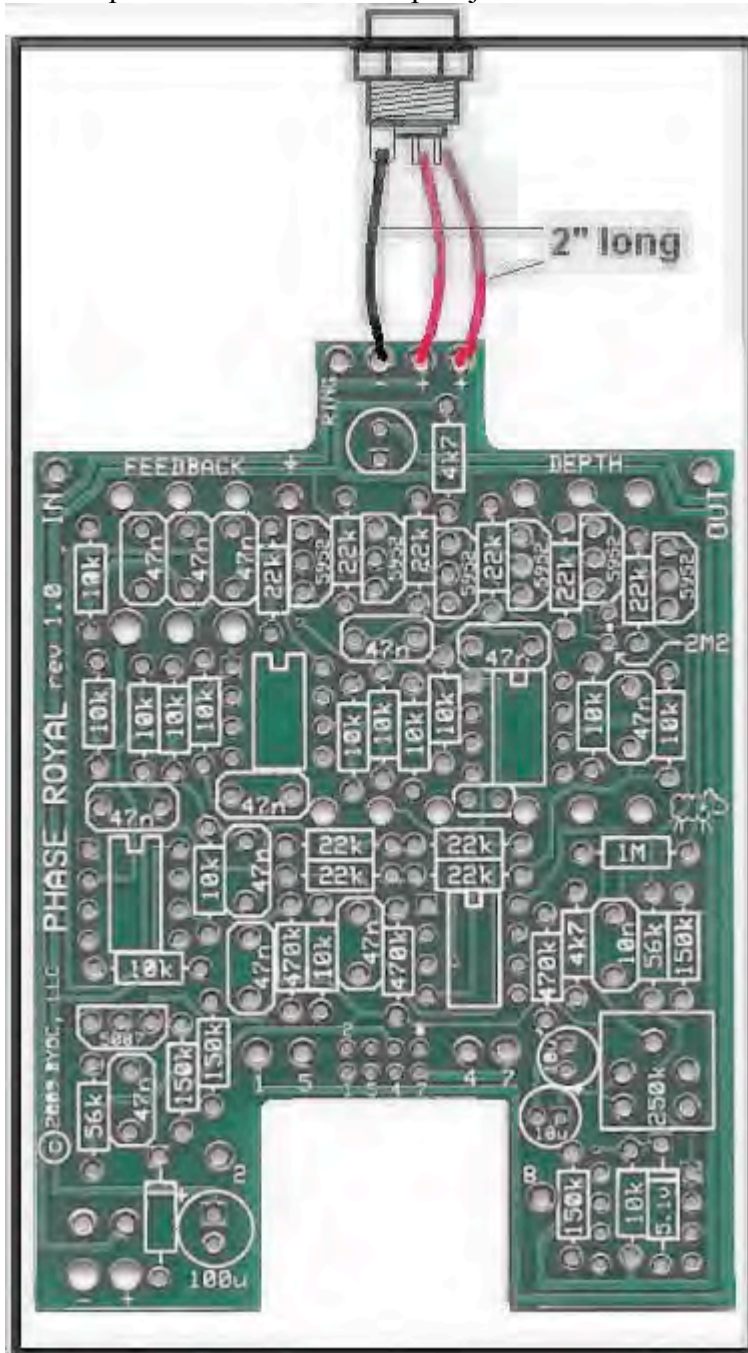

Step 2: Connect the TIP (negative) terminal of the DC adaptor jack to the “-” eyelet on the PCB with 2 inches of hook up wire. Connect the SLEEVE of the DC adaptor jack to the “+” eyelet on the far right side of the PCB with 2 inches of hook up wire. Connect the battery disconnect terminal of the DC adaptor jack to the “+” eyelet more towards the center of the PCB with 2” of hookup wire. Load the wires in from the bottom of the PCB and solder on the topside.

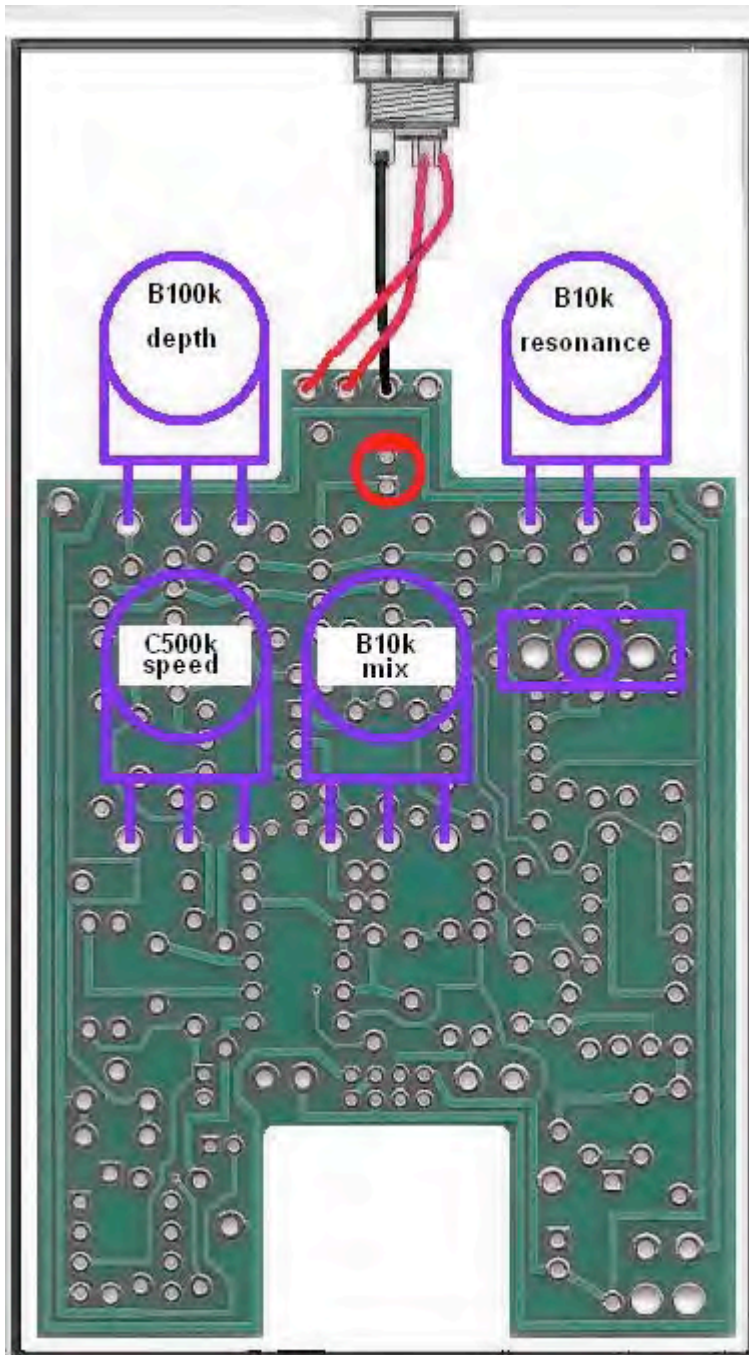

Step 3: Flip the PCB over so that the bottom or solder side is up. Insert the B100k(depth), B10k(resonance/feedback), C500K(speed), B10k (mix)potentiometers, the SPDT toggle switch, and the LED into the bottom side of the PCB. **DO NOT SOLDER ANYTHING YET!!!** The LED will have one lead that is longer than the other. The longer lead goes in the hole with the square solder pad.

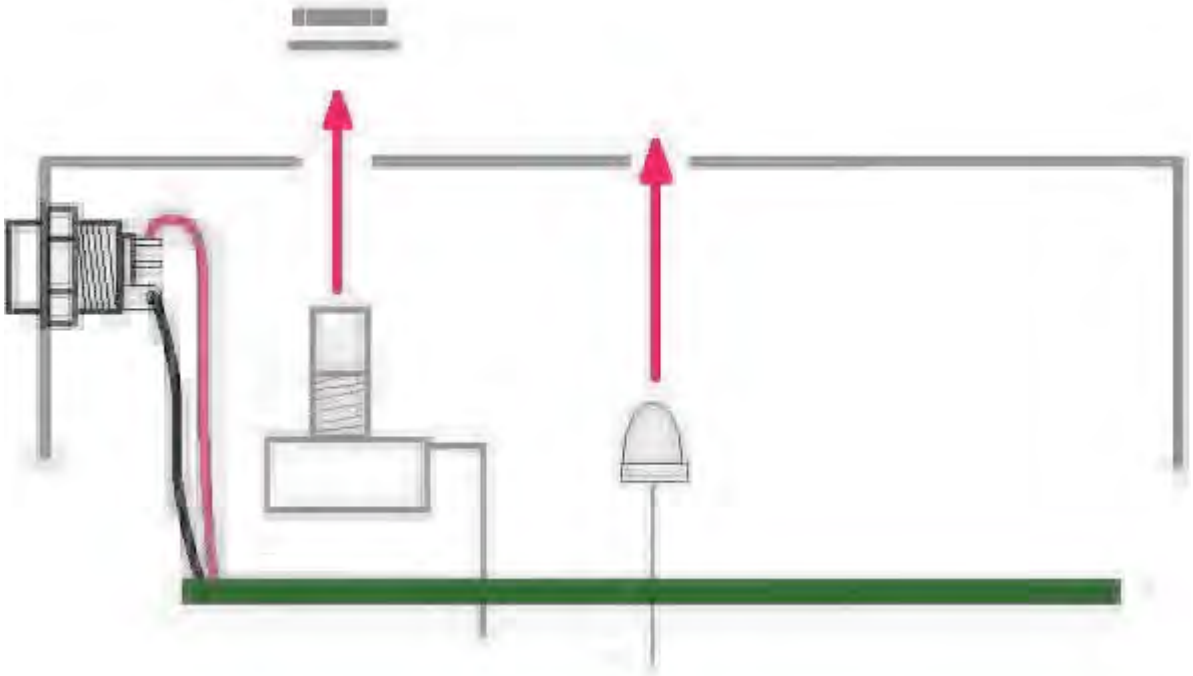

Step 4: Hold the PCB in one hand so that the component side of the PCB is in the palm of your hand and the bottom side with the pots, toggle switch and LED is facing up. Now use your other hand to guide the predrilled enclosure onto the PCB assembly so that the pots and LED all go into their respective holes. Once the PCB assembly is in place, secure it by screwing on the washers and nuts for the pots and toggle switch. Only tighten them with your fingers. You do not want them very tight yet. Be sure to keep your hand on the PCB so that it does not fall off the PC mounting posts of the pots and toggle switch.

Step 5: Turn the entire pedal over so that the component side of the PCB is facing up. Lift the PCB up off the pots and toggle switch about 2mm just to make sure that the back of the PCB does not short out against that pots. Make sure the PCB is level and symmetrically seated inside the enclosure.

Step 6: Solder the pots and LEDs. You will solder these parts on the component side of the PCB. After you have soldered them in place, be sure to tighten up their nuts.

Wiring

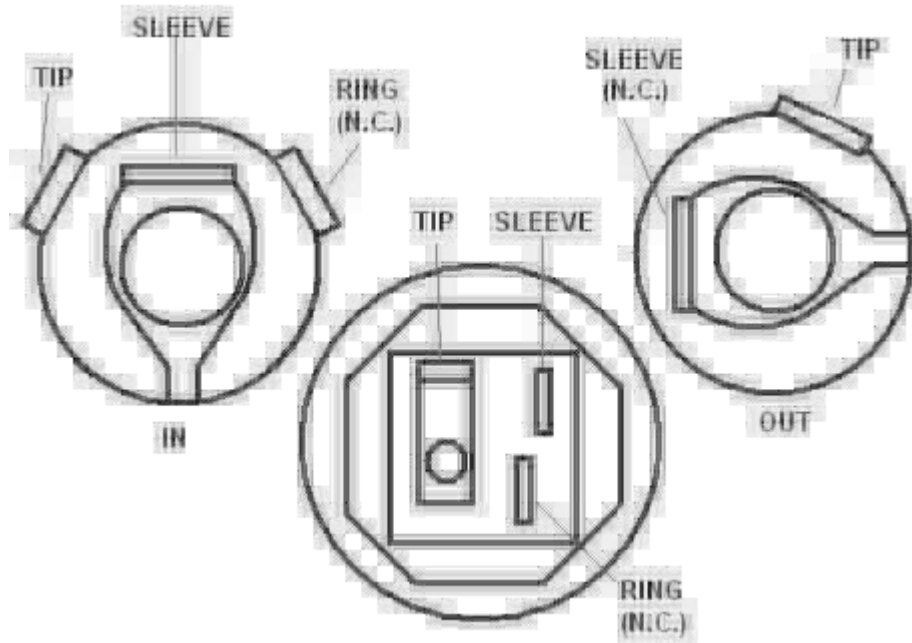

Step 1: Install the 1/4" jacks to the enclosure. Be sure to turn the OUT jack a 1/4 turn counter clockwise so that solder terminal for the tip does not short out against the enclosure.

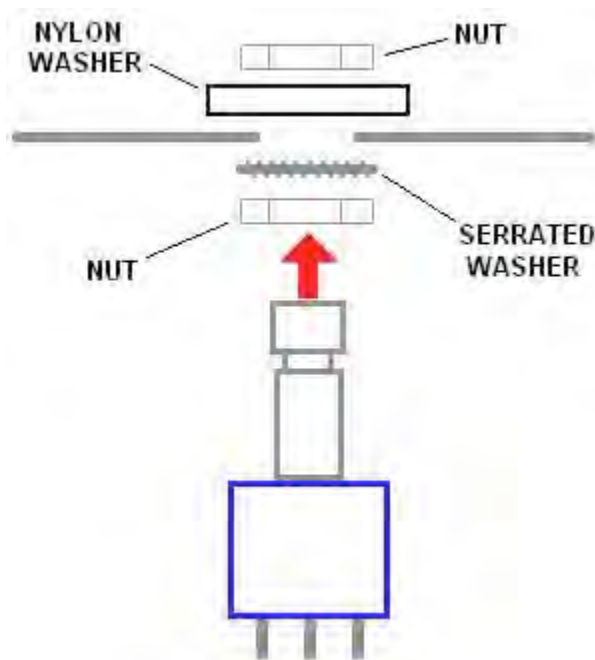

Step 2: Install the footswitch. Orient the footswitch so that the flat sides of the solder lugs are like the diagram below. NOTE: There are no actual number markings on the footswitch. There are two correct ways you can orient the footswitch. They are both 180 degrees of each other. Either way is fine. It

does not matter as long as the flat sides of the solder lugs are running horizontal, not vertical.

Step 2: Install the footswitch. Orient the footswitch so that the flat sides of the solder lugs are like the diagram below. NOTE: There are no actual number markings on the footswitch. There are two correct ways you can orient the footswitch. They are both 180 degrees of each other. Either way is fine. It does not matter as long as the flat sides of the solder lugs are running horizontal, not vertical.

Footswitch Solder Lug Designations

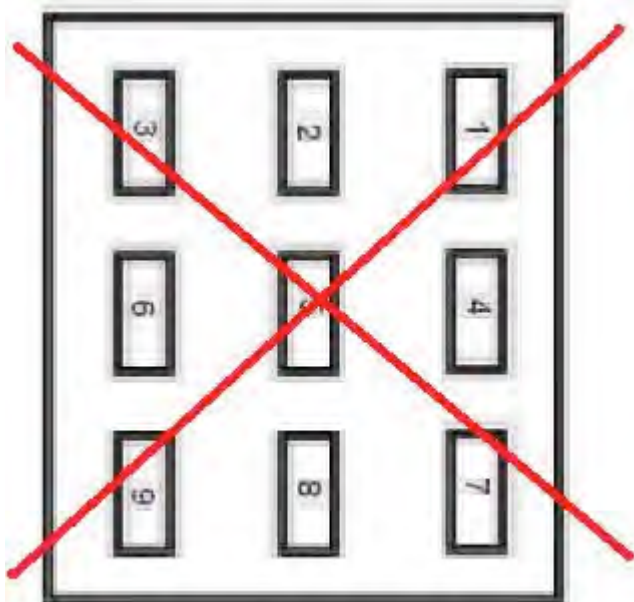
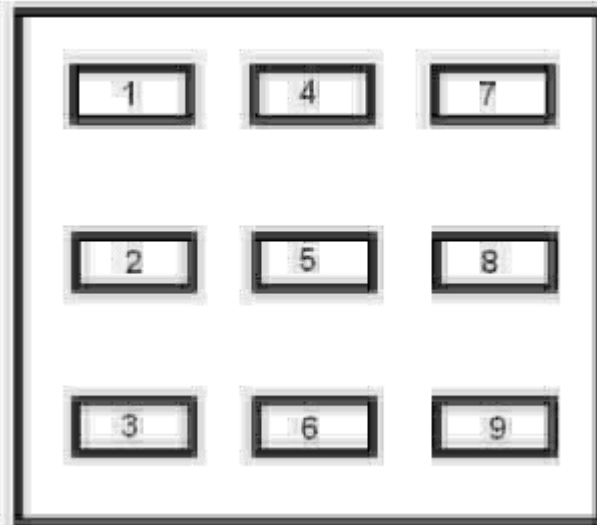

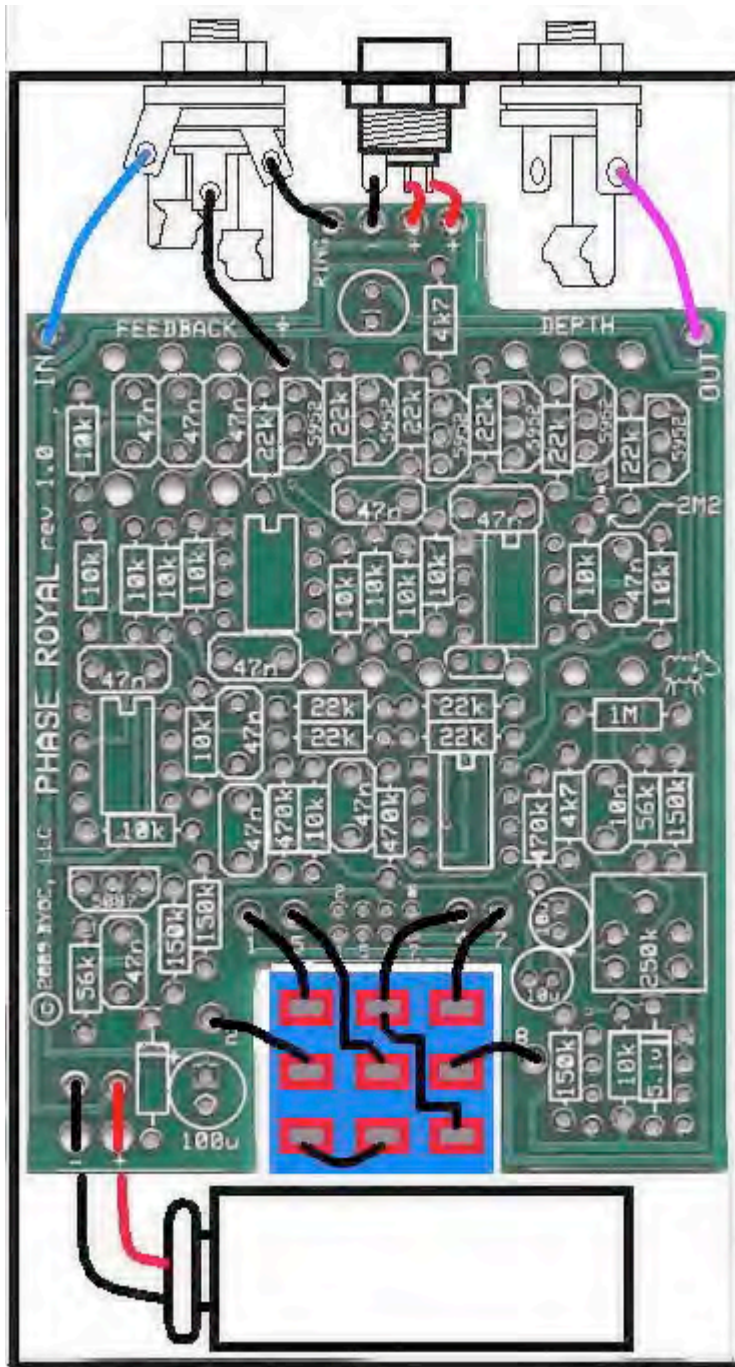

Step 3: Connect the pre stripped and tinned wires to the 1/4" jacks.

Step 4:

- Cut 4 x 3/4" pieces of wire. Strip 1/8" off each end. These will be used to connect lugs/eyelets 1, 2, 7, & 8
- Cut 1 x 1" piece of wire. Strip 1/8" off each end. This will be used to connect lug/eyelet 5
- Cut 1 x 1.5" peice of wire. Strip 1/8" of one end. Strip 1/2" off the other end. This will be used to connect lug/eyelet 4. The longer stripped end will be used to jumper

lug 4 to 9.

- Cut 3 x 2" pieces of wire. Strip 1/4" off each end. These will be used to connect the tip and sleeve of the IN jack and the tip of the OUT jack to the PCB.
- Cut 1 x 1.5" peice of wire. Strip 1/4" off each end. This will be used to connect the ring of the IN jack to the ring eyelet on the PCB.

Step 5: Solder one end of the pre-cut and pre-stripped wires to the footswitch.

Step 6: Insert the other remaining ends of the pre-cut and pre-stripped wires into the topside of the PCB and solder. You can solder these on the topside as well. It is easier this way, but you may burn a small amount of the PVC coating on the wires. This is purely asthetic and won't damage the wires in anyway. But you can avoid this by removing the PCB assembly and footswitch from the enclosure entirely (the PCB assembly will still be attached to the enclosure via the DC jack wiring) so that you have access to solder the underside of the PCB.

Installing the IC's and Finishing Up

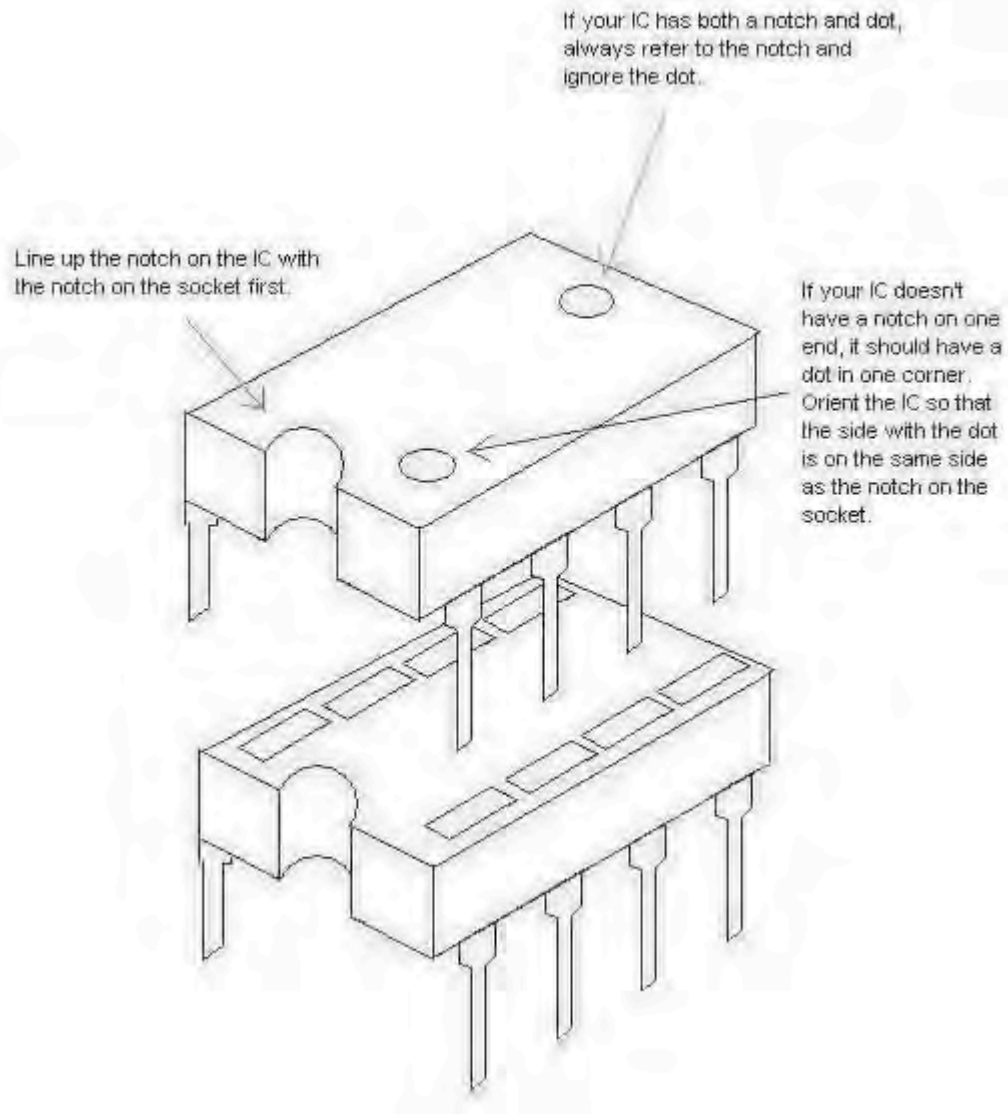

Don't forget to adjust your trimpot. Then put the cover on the enclosure and apply the bumpers to the cover if you like to use them.

Operating Overview

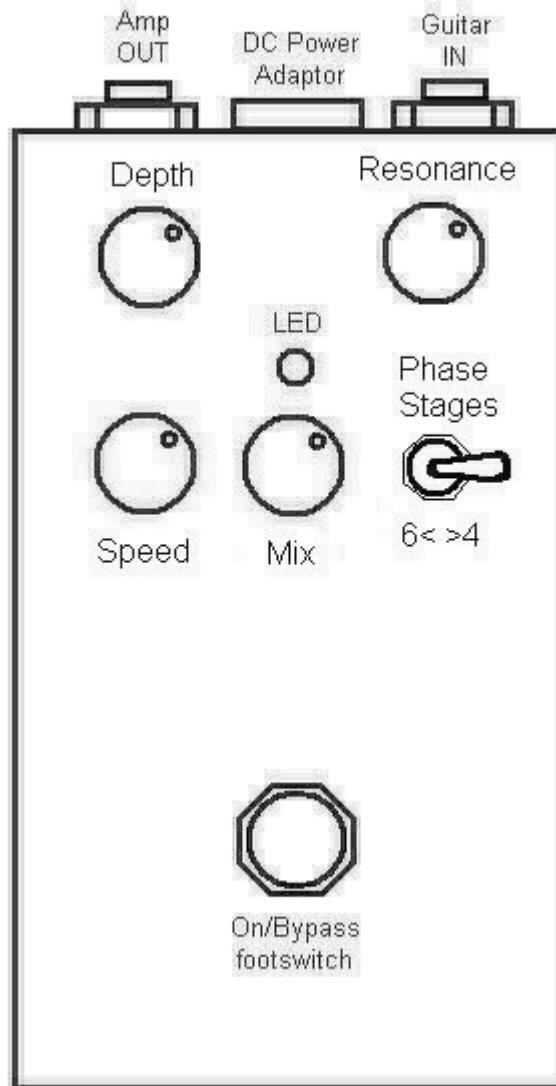

DEPTH: Sometimes called Width or Intensity. Controls intensity of the actual phase shifting.

MIX: Sometimes called Ratio or Blend. Controls the mix of dry & phase shifted signal. Clockwise = more clean signal. Counter Clockwise = more phase shifting

SPEED: Sometimes called Rate or Frequency. Controls how fast the phase shifting moves.

RESONANCE: Sometimes called Feedback. Controls how much phase shifted signal is looped back into the phase stages.

4/6 PHASE STAGES SWITCH: Toggle right = 4 phase stages. Toggle left = 6 phase

stages.

DC power supply - Use a 2.5mm negative tip 9VDC adaptor (this is your standard guitar fx style adaptor). If using battery power, only use a single 9V battery.

Current Draw - 5.5mA

Input Impedance - 470k ohms

Output Impedance - 150k ohms

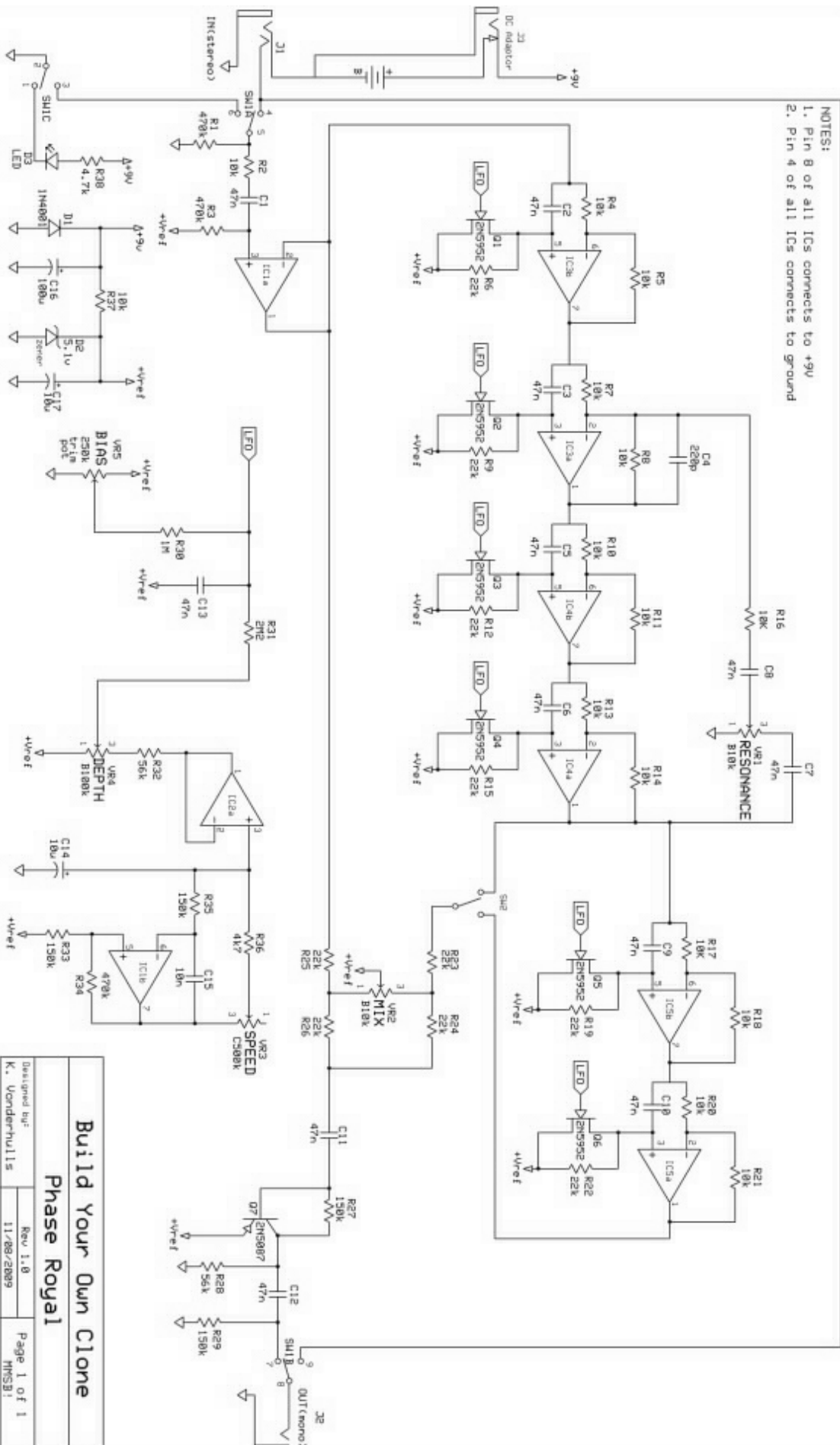

- NOTES:
1. Pin 8 of all ICs connects to +9V
 2. Pin 4 of all ICs connects to ground

Please visit
<http://buildyourownclone.com/board>
for any technical support

copyright 2009
B.Y.O.C., LLC