

RoHS compliant

REV.	ZONE	LTR	DESCRIPTION	DATE	REVISER	APPD.
1.0	/		NEW RELEASE	2020/9/30	ZHENG	VBGAS

USB 3.0 A Male P1

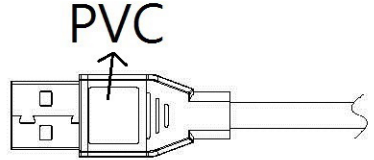
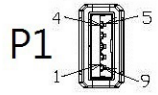

400mm±30

USB 3.1 Type C Male P2

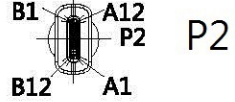
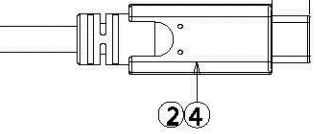

Soft rubber materials

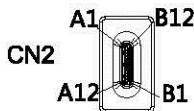
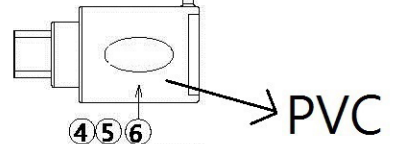

CN1

Pin Assignment  
3.0 A Female Type C Male

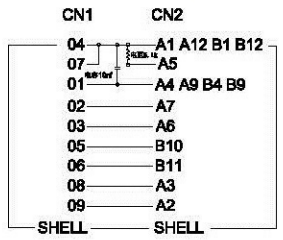

Pin Assignment

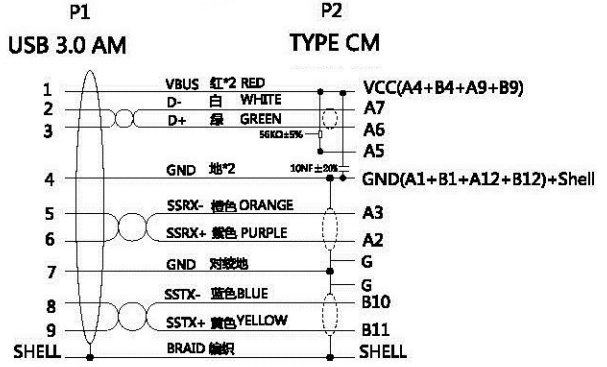

- 技术要求：
- 1.开路、短路、错位、瞬间开/短路必须100%测试
  - 2.导通阻值：3Ω MAX
  - 3.绝缘阻抗：5MΩ MIN
  - 4.测试电压：DC 300V
  - 5.外观无刮伤、压伤、异物等不良
  - 7.产品符合最新ROHS标准.
  8. Transmission Speed : USB 3.1 Gen 1 5Gbps

6	Adaptor	USB 3.0 A Female To Type C Male	1	PCS
5	Outer Mold Materials	PVC 45P Black		g/PCS
4	Inner Mold Materials	UV胶 (高温胶) +PE		g/PCS
3	A Male	USB3.0,AM, 焊线式 三件套, 铁壳接插,PIN:15U* 金,蓝胶 +线夹	1	SET
2	Type C	C2M拉伸电镀壳端子镀金15u黑胶3.0 A-C C1=10nF电容 Rp=56kΩ电阻10PAD +线夹+屏蔽壳	1	SET
1	Cable	USB 3.1 (30AWG7/0.10TC*1P+EAM ) *2C+(30AWG7/0.10TC*1P+AL ) +24AWGX2C红+D24AWGX2C+填充+EAB (16*9/0.08TC) TPE OD4.5 BLACK Outer jacket : TPE No words printed on the cable	1	PCS

序号 ITEM	品名 PART NAME	DESCRIPTION	用量 QTY.	单位 UNIT
------------	-----------------	-------------	------------	------------

NAME: CUSTOMER DRAWING		UNIT: mm	SCALE: 1:1	Oyen Digital LLC	
GENERAL TOLERANCE (UNLESS SPECIFIED)		DESIGNER:	USB 3.1 Gen 1 C Male To A Male (With 3.0 A Female To C Male Adapter), Black, Total Length 0.4M		
.0 0 0 ± 0.15		CHECKED:			
.0 0 ± 0.25		APPROVED:			
.0 ± 0.35					
ANGLE ± 1°					
SIZE: A4	DRAWING NO.:			SHEET: 1/1	REV.: 1.0