

6D6A_xxy515

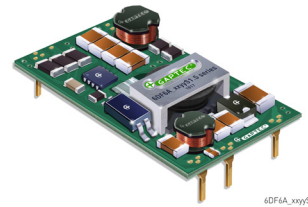

6D6A_xxy515

6D6AW_1.5RP Series

6W Single Output - Wide Input - Isolated & Regulated
DIP PACKAGE

DC-DC Converter

6 Watt

- ⊕ Wide input voltage range
- ⊕ 1.5KVDC/500VAC isolation
- ⊕ High efficiency up to 86%
- ⊕ Operation temperature range: -40°C ~ +85°C
- ⊕ No-load power consumption as low as 0.12W
- ⊕ Input under-voltage, over-current, over-voltage protection
- ⊕ DIP package
- ⊕ Industry standard pinout
- ⊕ RoHS compliance

The 6D6AW_1.5RP series are isolated 6W DC-DC products with 2:1 input voltage, featuring 500VAC/500VDC isolation, input under-voltage protection, output over-voltage, over-current, and short circuit protection.

This makes them widely applied in industrial control, electricity, instruments and communication fields.



Common specifications

Short circuit protection:	Continuous, automatic recovery
Cooling:	Free air convection
Operation temperature range:	-40°C to +85°C
Storage temperature range:	-55°C to +125°C
Lead temperature:	300°C (1.5mm from case for 10 sec.)
Vibration:	10-150Hz, 5G, 90 Min. along X, Y and Z
Storage humidity range:	< 95%
Case material:	Aluminium alloy
MTBF:	>1,000,000 hours
Dimensions:	31.60*18.10*6.10mm (without housing) 32.60*19.10*6.80mm (with housing)
Weight:	4.7g / 5.7g with housing

Input specifications

Item	Test condition	Min	Typ	Max	Units
Input current (full load/no load)	• 12VDC input				
	- 5V output		617/7	633/25	mA
	- 12V output		595/10	610/30	mA
	- 15V output		588/9	603/30	mA
	• 24VDC input				
	- 3.3V output		261/3	268/15	mA
- 5V output		301/4	308/18	mA	
- 12V output		294/5	302/20	mA	
- 15V output		291/5	398/20	mA	
Reflected ripple current			20		mA
Surge voltage (1 sec. max)	• 12VDC input	-0.7		25	VDC
	• 24VDC input	-0.7		50	VDC
Starting voltage	• 12VDC input			9	VDC
	• 24VDC input			18	VDC
Input under voltage protection	• 12VDC input	5.5	6.5		VDC
	• 24VDC input	13	15		VDC
Input filter	Capacitance filter				
Hot plug	Unavailable				
Ctrl*	• Module switch on	Ctrl suspended or connected to TTL low level (0-0.3VDC)			
	• Module switch off	Ctrl pin connected to high level (2-12VDC)			
	• Input current when switched off		5	10	mA

* The voltage of Ctrl pin is relative to input pin GND.

Output specifications

Item	Test condition	Min	Typ	Max	Units
Voltage accuracy	0%-100% load		±1	±3	%
Line regulation	full load, input voltage from low to high		±0.2	±0.5	%
Load regulation*	5%-100% load		±0.5	±1	%
Temperature drift	100% full load			±0.03	%/°C
Transient response deviation	25% load step change • 3.3V/5V output • others		±5	±8	%
			±3	±5	%
Transient recovery time	25% load step change		300	500	µs
Temperature coefficient	full load			±0.03	%/°C
Ripple&Noise**	20MHz Bandwidth			100	mVp-p
Trim			±5		%Vo
Output over voltage protection	Input voltage range	110		160	%Vo
Output over current protection	Input voltage range	110	140	200	%Io
Switching frequency	PWM mode		330		KHz

* When testing from 0% -100% load working conditions, load regulation index of ±5%;

** 0% - 5% load ripple&Noise is no more than 5%Vo Ripple and noise are measured by "parallel cable" method.

Isolation specifications

Item	Test condition	Min	Typ	Max	Units
Isolation voltage	Input-output; 1 min./ leak current <5mA	500			VAC
		1500			VDC
Isolation resistance	Input-output, isolation voltage 500VDC	100			MΩ
Isolation capacitance	Input-output, 100KHz/0.1V		1000		pF

Example:

6D6AW_0505S1.5RP

6= 6 Watt; D6= DIP6; A= Pinning; W= Wide input; 5Vin; 5Vout; S= Single Output; 1.5= 1.5kVDC; R= Regulated Output; P= Short Circuit Protection

6D6AW_1.5RP Series

6W Single Output - Wide Input - Isolated & Regulated
DIP PACKAGE

EMC specifications				
EMI	CE	CISPR22/EN55032	CLASS B	(see EMC recommended circuit, ②)
EMI	RE	CISPR22/EN55032	CLASS B	(see EMC recommended circuit, ②)
EMS	ESD	IEC/EN61000-4-2	Contact ±6KV	perf. Criteria B
EMS	RS	IEC/EN61000-4-3	10V/m	perf. Criteria A
EMS	EFT	IEC/EN61000-4-4	±2KV	perf. Criteria B (see EMC recommended circuit, ③)
EMS	Surge	IEC/EN61000-4-5	line to line ±2KV	perf. Criteria B (see EMC recommended circuit, ③)
EMS	CS	IEC/EN61000-4-6	3 Vr.m.s	perf. Criteria A

Part Number	Input Voltage [V]			Output Voltage [VDC]	Current [mA, max]	Efficiency [%, typ]	Capacitive load [%, max]
	Nominal	Range	Max				
6D6AW_1205S1.5RP	12	9-18	20	5	1200	81	1000
6D6AW_1212S1.5RP	12	9-18	20	12	500	84	680
6D6AW_1215S1.5RP	12	9-18	20	15	400	85	470
6D6AW_2403S1.5RP	24	18-24	40	3.3	1500	79	1800
6D6AW_2405S1.5RP	24	18-24	40	5	1200	83	1000
6D6AW_2412S1.5RP	24	18-24	40	12	500	85	680
6D6AW_2415S1.5RP	24	18-24	40	15	400	86	470

Notes: DIP package without housing: 6DF6AW_xxyyS1.5RP

Efficiency

Efficiency Vs Input Voltage (Full Load)

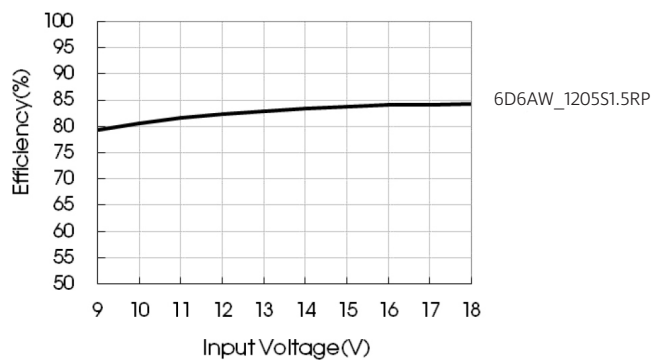

Efficiency Vs Output Load (Vin=12VDC)

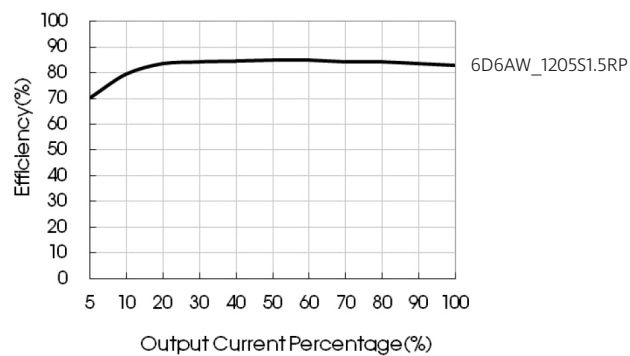

Efficiency Vs Input Voltage (Full Load)

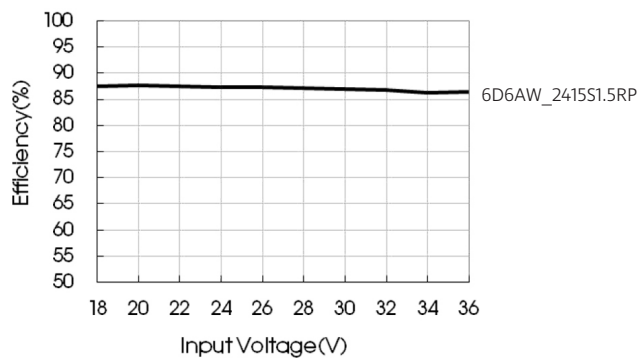

Efficiency Vs Output Load (Vin=24VDC)

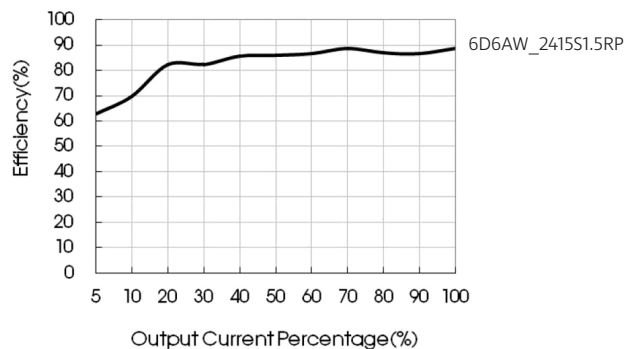

6D6AW_1.5RP Series

6W Single Output - Wide Input - Isolated & Regulated
DIP PACKAGE

Typical characteristics

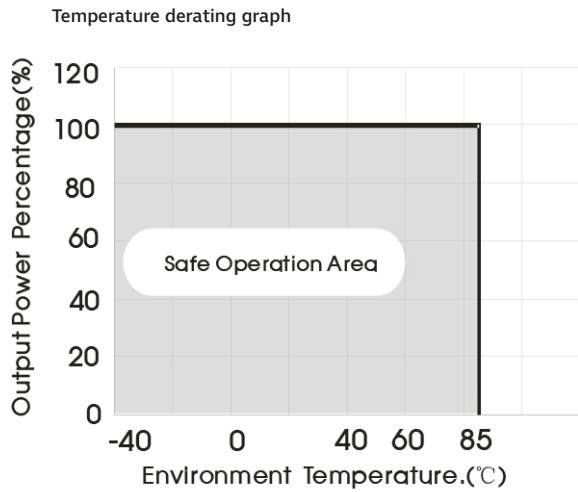

Typical application

All the DC/DC converters of this series are tested according to the recommended circuit (see below) before delivery.

If it is required to further reduce input and output ripple, properly increase the input & output of additional capacitors C_{in} and C_{out} or select capacitors of low equivalent impedance provided that the capacitance is no larger than the max. capacitive load of the product.

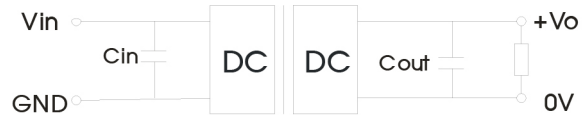

Vout(VDC)	Cin(uF)	Cout(uF)
3.3/5/12/15	10	10

EMC solution-recommended circuit

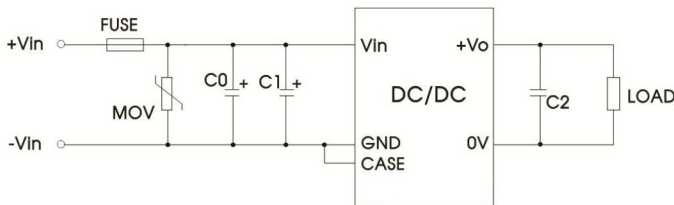

Parameter description:

Model	Vin: 12VDC/24VDC
FUSE	Choose according to actual input current
MOV	S20K30
C0	680µF/100V
C1	330µF/100V
C2	10µF/25V

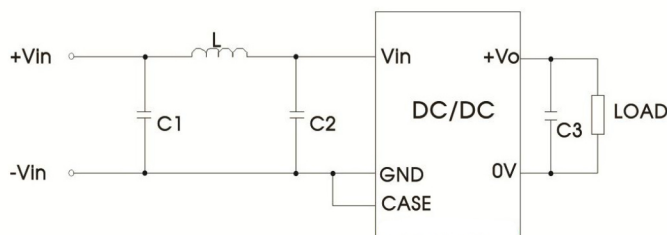

Parameter description:

Vin(VDC)	C1/C2	L	C3
12/24	4.7µF/50V	4.7µH	10µF/25V

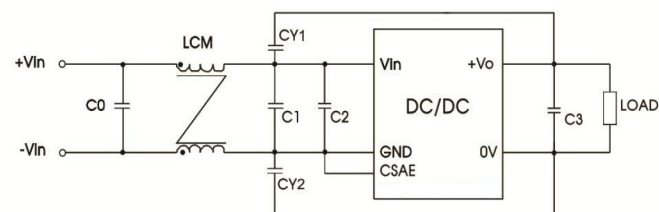

Parameter description:

Model	Vin: 12VDC/24VDC
C0	4.7µF/50V
C1	4.7µF/50V
C2	4.7µF/50V
C3	10µF/25V
LCM	3.3mH
CY1/CY2	1000pF/≥2000VDC

6D6AW_1.5RP Series

6W Single Output - Wide Input - Isolated & Regulated
DIP PACKAGE

Application of Trim and calculation of Trim resistance

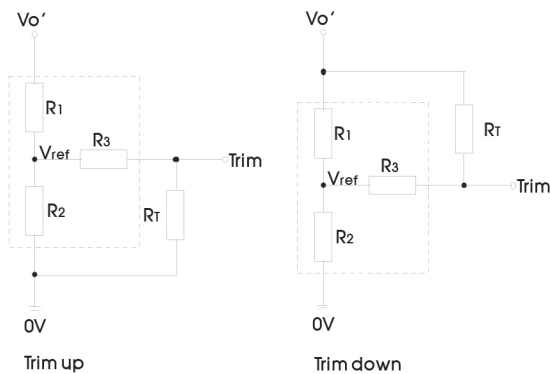

Calculation formula of Trim resistance:

$$\begin{aligned} \text{up: } R_T &= \frac{\alpha R_2}{R_2 - \alpha} - R_3 & \alpha &= \frac{V_{ref}}{V_{o'} - V_{ref}} \cdot R_1 \\ \text{down: } R_T &= \frac{\alpha R_1}{R_1 - \alpha} - R_3 & \alpha &= \frac{V_{o'} - V_{ref}}{V_{ref}} \cdot R_2 \end{aligned}$$

R_T is Trim resistance, α is a self-defined parameter, with no real meaning.
 $V_{o'}$ for the actual needs of the up or down regulated voltage

Applied circuits of Trim (Part in broken line is the interior of models)

Model	R_1 (K Ω)	R_2 (K Ω)	R_3 (K Ω)	V_{ref} (V)
6D6AW_1205S1.5RP	2.94	2.87	10	2.5
6D6AW_1212S1.5RP	11	2.87	15	2.5
6D6AW_1215S1.5RP	14.5	2.87	15	2.5
6D6AW_2403S1.5RP	4.8	2.87	12	1.24
6D6AW_2405S1.5RP	2.94	2.87	15	2.5
6D6AW_2412S1.5RP	11	2.87	33	2.5
6D6AW_2415S1.5RP	14.5	2.87	15	2.5

It is not allowed to connect modules output in parallel to enlarge the power.

Mechanical dimensions with housing

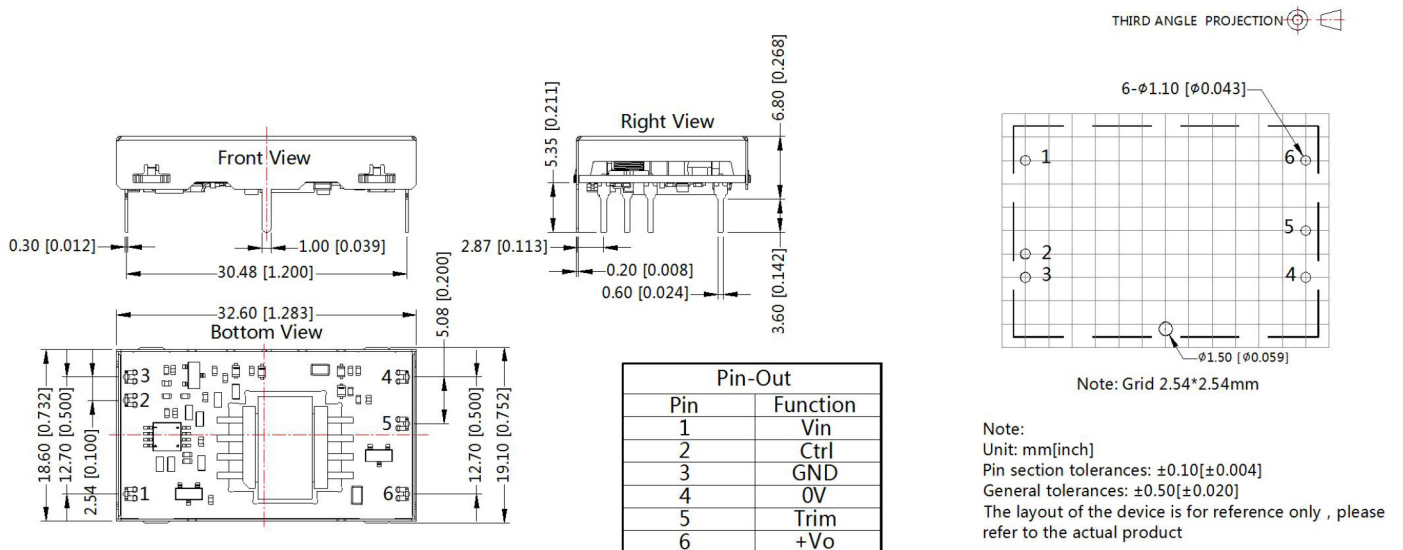

6D6AW_1.5RP Series

6W Single Output - Wide Input - Isolated & Regulated
DIP PACKAGE

Mechanical dimensions without housing

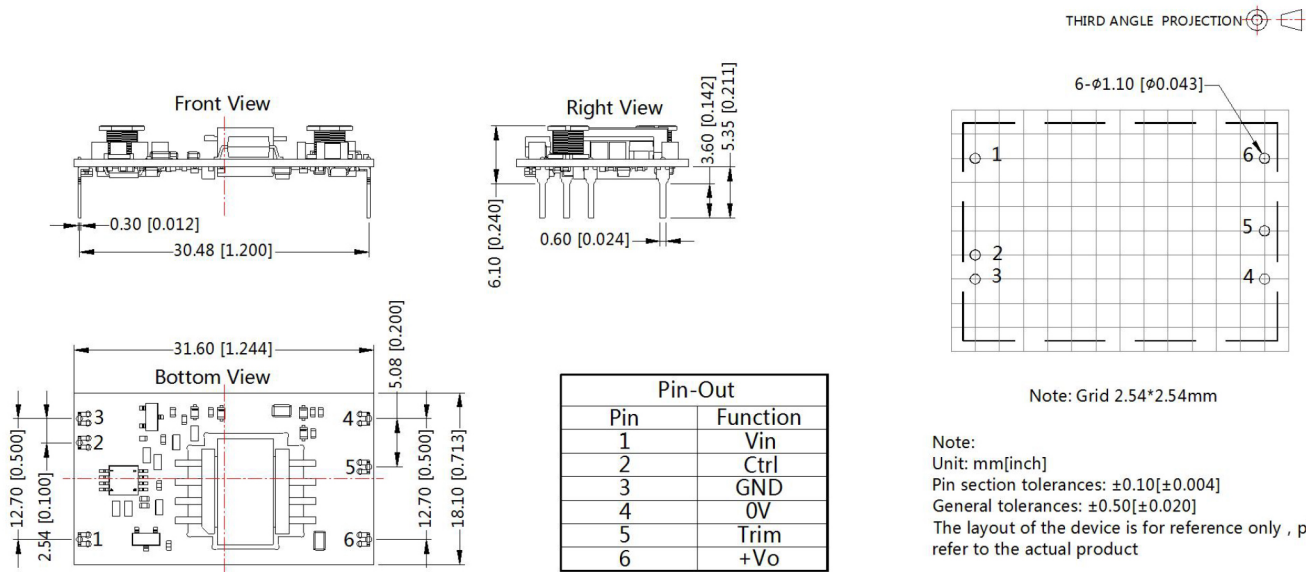

Note:

1. The maximum capacitive load offered were tested at nominal input voltage and full load;
2. Unless otherwise specified, parameters in this datasheet were measured under the conditions of $T_a = 25^\circ\text{C}$, humidity <75% with nominal input voltage and rated output load;
3. All index testing methods in this datasheet are based on our Company's corporate standards;
4. The performance parameters of the product models listed in this manual are as above, but some parameters of non-standard model products may exceed the requirements mentioned above. Please contact our technicians directly for specific information;
5. We can provide product customization service;
6. Specifications are subject to change without prior notice.