

Temperature and Humidity sensor MW3827ARRE Data Sheet

Description

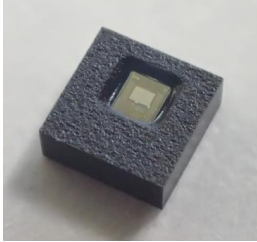

The MW3827 is a combined relative humidity and temperature sensor module. The dual sensor is also combined with our custom analog front end to provide a fully calibrated and temperature compensated digitized I²C output. The MW3827 proprietary polymer and parallel plate capacitive structure provides excellent robustness and reliability. No complicated sensor drive or control circuit is required, and high performance sensing is achievable only with the MW3827 and an external microcontroller which works as a host.

Features

- Small package: 2.0(W) × 2.0(D) × 0.8(H)mm
- Operating temperature ranges -40~+105°C
- Operating Humidity ranges 0~100%RH
- Supply voltage 2.2~5.5V
- Current consumption 8.97μA Typ. (@1sample/sec.)
- Current consumption at sleep 0.85μA Typ.
- Output corrected humidity value with repeatability of 0.015%RH (I²C)
- Equipped with a heater for checking operation
- 8-bit I²C address 50h(Write), 51h(Read)
- RoHS compliant
- Halogen-free

Contents

Description.....	1
Features	1
BLOCK DIAGRAM.....	3
PIN CONFIGURATION.....	4
TERMINAL EXPLANATIONS	5
EQUIVALENT CIRCUIT OF THE PINS	6
ABSOLUTE MAXIMUM RATINGS	7
RECOMMENDED OPERATING CONDITIONS	7
Power-on sequence	8
Reapply voltage sequence.....	8
ELECTRICAL CHARACTERISTICS	9
Analog characteristics	9
Humidity sensor characteristics	10
Temperature sensor characteristics	10
Digital I/O.....	11
DEFINITION OF CHARACTERISTICS	12
FUNCTION	13
Description of operation method.....	13
Description of state (Sleep State / Measurement State).....	13
About system design	13
Detailed description of Measurement state	14
Heater function	16
State transition table	17
State transition diagram.....	18
Control register	19
Status register.....	20
Method of calculation to temperature and humidity values.....	21
SERIAL INTERFACE	22
I ² C format.....	22
Write format	22
Read format.....	23
Combined format.....	24
I ² C AC characteristics.....	25
TYPICAL APPLICATION CIRCUIT	26
TYPICAL PERFORMANCE CHARACTERISTICS	27
DIMENSIONS	30
MARKING CONTENTS	31
CONDITION FOR PACKAGE MOUNTING	33
Design example of mount pad.....	33
Pb-Free recommended profile condition	34
Rehydration treatment.....	34
Storage method	35
PACKAGING SPECIFICATION.....	37

BLOCK DIAGRAM

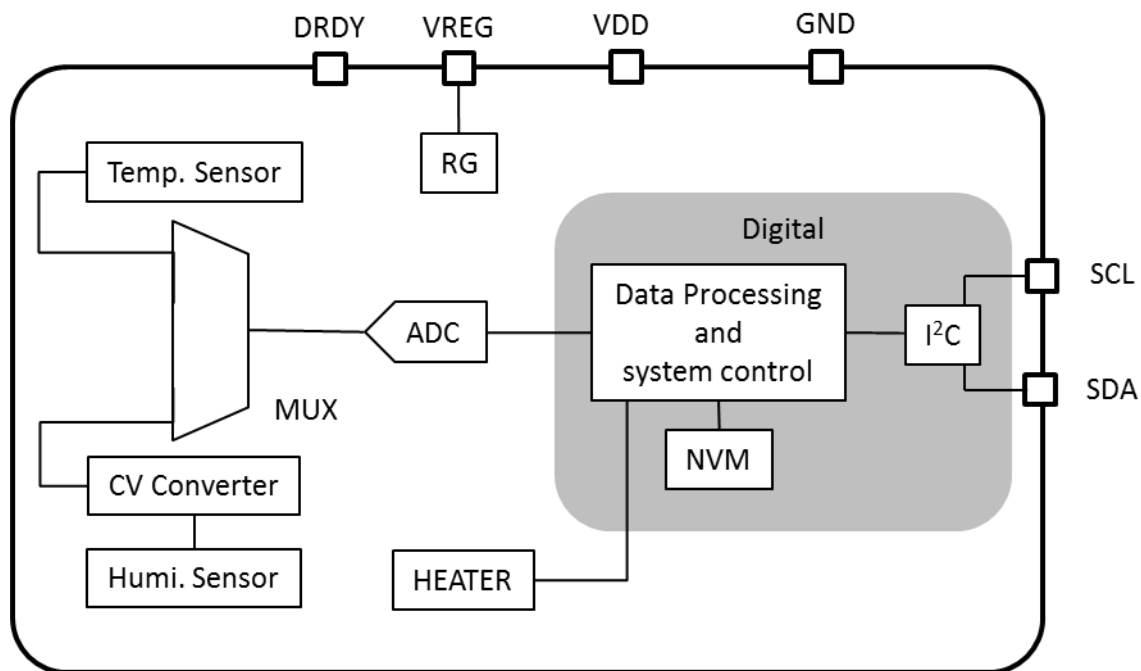

Fig.1 Block diagram

PIN CONFIGURATION

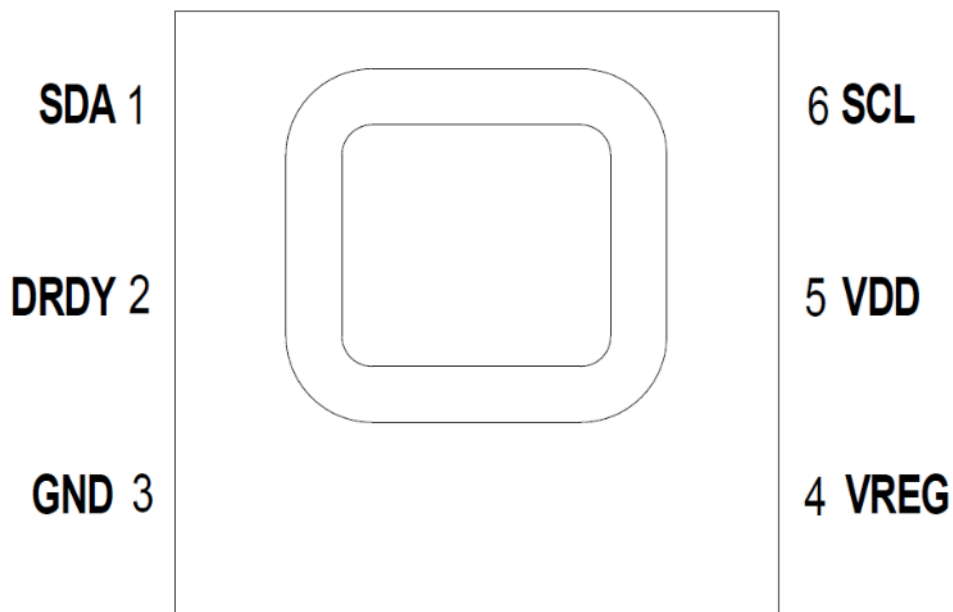

Fig.2 Pin configuration (Top view)

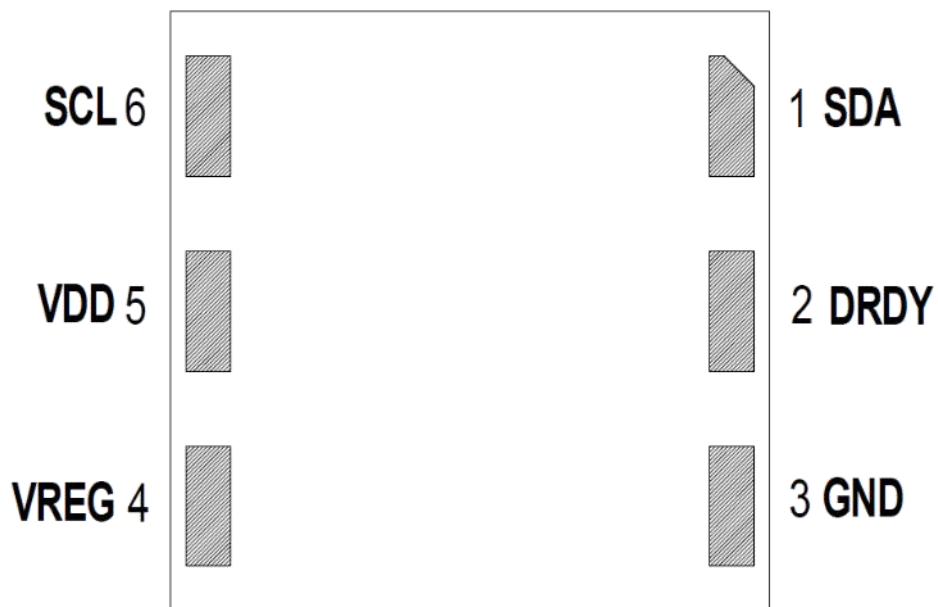

Fig.3 Pin configuration (Bottom view)

TERMINAL EXPLANATIONS

Table.1 Pin table

No.	Pin Name	Type	Function
1	SDA	I/O	Serial Data (Input and output) for I ² C communication(SDA)
2	DRDY	O	Output terminal which notifies the completion of temperature and humidity measurement and calculation correction (positive logic)
3	GND	-	GND
4	VREG	O	VREG Connect to a 0.1μF capacitor to GND. (Note ¹) Do not connect anything to it other than. If it is not connected, the sensor may be destroyed.
5	VDD	I	Power supply (Connect to bypass capacitor;1μF)
6	SCL	I/O	Serial clock for I ² C communication(SCL)

note¹: It is recommended to use a capacitor with a nominal value of 0.1μF, an allowable capacitance value of ±10% or less, and thermal characteristics of ±15% or less.

EQUIVALENT CIRCUIT OF THE PINS

Table.2 Pin table

Pin Name	Type	Equivalent Circuit of the pins
SCL SDA	I/O	
DRDY	O	
VREG	O	
VDD	I	

ABSOLUTE MAXIMUM RATINGS

(Unless otherwise specified, Ta=25°C, VDD=3.3V)

Item	Symbol	Min.	Max.	Unit
Storage temperature range	T _{STG}	-40	+125	°C
Analog supply voltage	VDD _{MAX}	-0.3	+6.0	V
Digital input voltage	VDIN _{MAX}	-0.3	VDD+0.3	V

RECOMMENDED OPERATING CONDITIONS

(Unless otherwise specified, Ta=25°C, VDD=3.3V)

Item	Symbol	Min.	Max.	Unit
Operating temperature range	T _{OPR}	-40	+105	°C
Operating humidity range	H _{OPR}	0	100	%RH
Analog supply voltage	VDD _{OPR}	+2.2	+5.5	V
Digital input voltage	VDIN _{OPR}	0	VDD	V

Power-on sequence

When the power is turned on, access the device at least 15msec. after reaching 90% of the applied voltage. (note²)

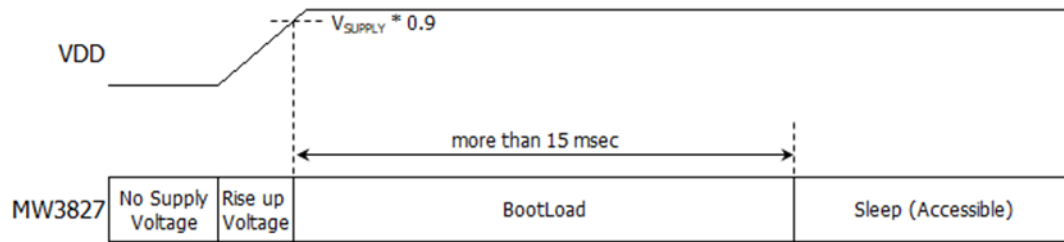

Fig.4 Power-on sequence

Reapply voltage sequence

When turning on the power again, wait until VDD drops below 0.1V, and then turn on the power again after at least 6msec has elapsed.

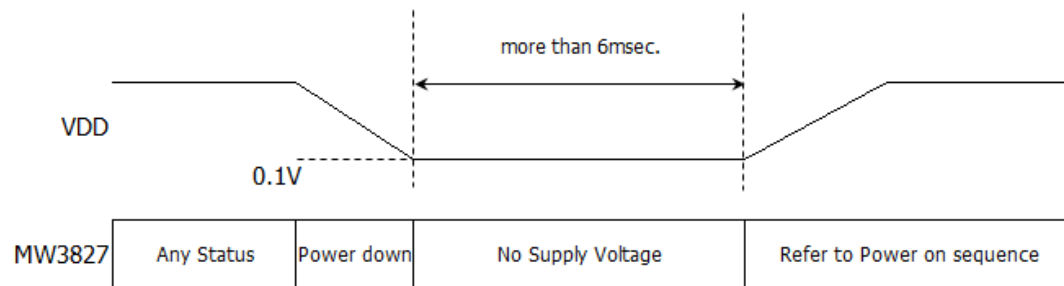

Fig.5 Reapply voltage Sequence

note²: The above power-on sequence operation may fail when the power is turned on, for example, if the power waveform is not appropriate. If the power-on sequence fails, MW3827 transitions to a setting that rejects I²C communication, reflecting the error state in the ERR_BL bit of the status register, in order to prevent the error from continuing to operate in the abnormal state. Refer to the [Status register](#) for details on how to check and return.

ELECTRICAL CHARACTERISTICS

Analog characteristics

(Unless otherwise specified, Ta=25°C, VDD=3.3V)

Item	Symbol	Condition	Min.	Typ.	Max.	Unit.
Current consumption	I _{DD}	One Shot Operation 1sample/sec. (note ³)	-	8.97	14.2	μA
Current consumption at Sleep	I _{DDSL}	At Sleep state (note ⁴)	-	0.85	1.6	μA
Current consumption at Standby	I _{DDSB}	At Standby state (note ⁴)	-	0.95	1.8	μA
Current consumption at Measurement	I _{DDM}	At Measurement state (note ⁴)	-	1120	1420	μA
Current at Heater-ON (note ⁵)	I _{HEAT}		-	10	(TBD)	mA
VREG voltage	V _{RGSL}	At Sleep state (note ⁴)	1.71	1.8	1.89	V
	V _{RGACT}	At Active	1.71	1.8	1.89	V

note³: The average of one sample per second by One Shot Operation.note⁴: For details of each state, refer to [Description of the state](#) or [State transition diagram](#).note⁵: About setting heater, please see [Heater function](#).

Humidity sensor characteristics
(Unless otherwise specified, Ta=25°C, VDD=3.3V)

Item	Symbol	Condition	Min.	Typ.	Max.	Unit
Humidity accuracy	H _{acc}	25°C, 50%RH	-	±2	-	%RH
Humidity repeatability	H _{rep}		-	0.015	-	%RH RMS
Humidity hysteresis	H _{hys}	Ta=25°C	-1	-	+1	%RH
Humidity response time	t _{HRESP}	10⇔90%RH @Ta=25°C, τ=63% Air flow 1m/s	-	6	-	sec.

Temperature sensor characteristics
(Unless otherwise specified, Ta=25°C, VDD=3.3V)

Item	Symbol	Conditions	Min.	Typ.	Max.	Unit
Temperature accuracy	T _{acc}	Ta = 25°C	-0.5	-	+0.5	°C

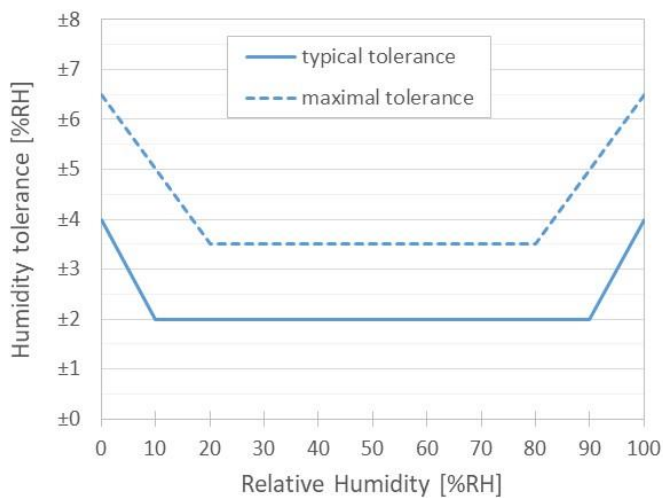

Fig.6 Humidity tolerance at 25°C

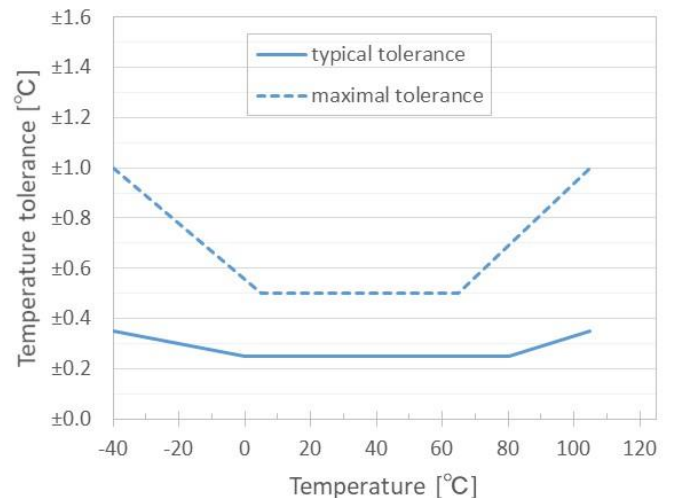

Fig.7 Temperature tolerance

Digital I/O

(Unless otherwise specified, Ta=25°C, VDD=3.3V)

Item	Symbol	Conditions	Min.	Typ.	Max.	Unit
High level input voltage	V _{IH}	SCL, SDA	0.7 × VDD	-	VDD +0.3	V
Low level input voltage	V _{IL}	SCL, SDA	-0.3	-	0.3 × VDD	V
Output voltage High level	V _{OH}	DRDY I _{OH} =-3mA	0.8 × VDD	-	-	V
Output voltage Low level	V _{OL}	SCL, SDA, DRDY I _{OL} =3mA	-	-	0.4	V

DEFINITION OF CHARACTERISTICS

To be released

FUNCTION

Description of operation method

MW3827 operates on the I²C interface and the slave address (7-bit) is 28h. The operation is controlled by specifying the control register in the write format. When accessed in the read format, the measurement result can be read as a digital value. For the method of calculating the digital value to temperature and humidity, refer to [Method of calculation to temperature and humidity values](#). The status register reflects the operating state and reads the register value by specifying the register address in the combination format

Description of state (Sleep State / Measurement State)

MW3827 transitions to the state according to the control register settings. There are two types of state: Sleep state and Measurement state. Additionally, there are two types of Measurement state: One Shot Operation and Repeat Operation. The outline is shown below

- Sleep state ... Waiting state.
- Measurement state
 - 1) Repeat Operation ... Repeat measurement for each set T_{Standby} .
 - 2) One Shot Operation ... Only one time measurement.

For details of each state, refer to [State transition table](#) and [State transition diagram](#).

About system design

1) Repeat Operation

This is a MW3827 initiative and is intended to be timing-controlled. MCU is used in the basic Sleep. DRDY of MW3827 is used to release Sleep of the MCUs at regular intervals to reduce the current of the entire system.

2) One Shot Operation

This operation is based on the assumption that the timing should be controlled under the initiative of the MCU. Measurement is instructed by the MCU each time. After measuring is complete, MW3827 transitions to Sleep and waits with minimal current savings.

Detailed description of Measurement state

Repeat Operation

Repeat Operation is measured continuously according to $T_{Standby}$ setting. Set the operation state setting bit SET_STATE [2:0] of the control register to 001b. Set the standby time $T_{Standby}$ for repeat measurements with the Standby time setting bit TSTBY[2:0]. After the measurement is completed, the previous measurement results are discarded and the new measurement results are retained.

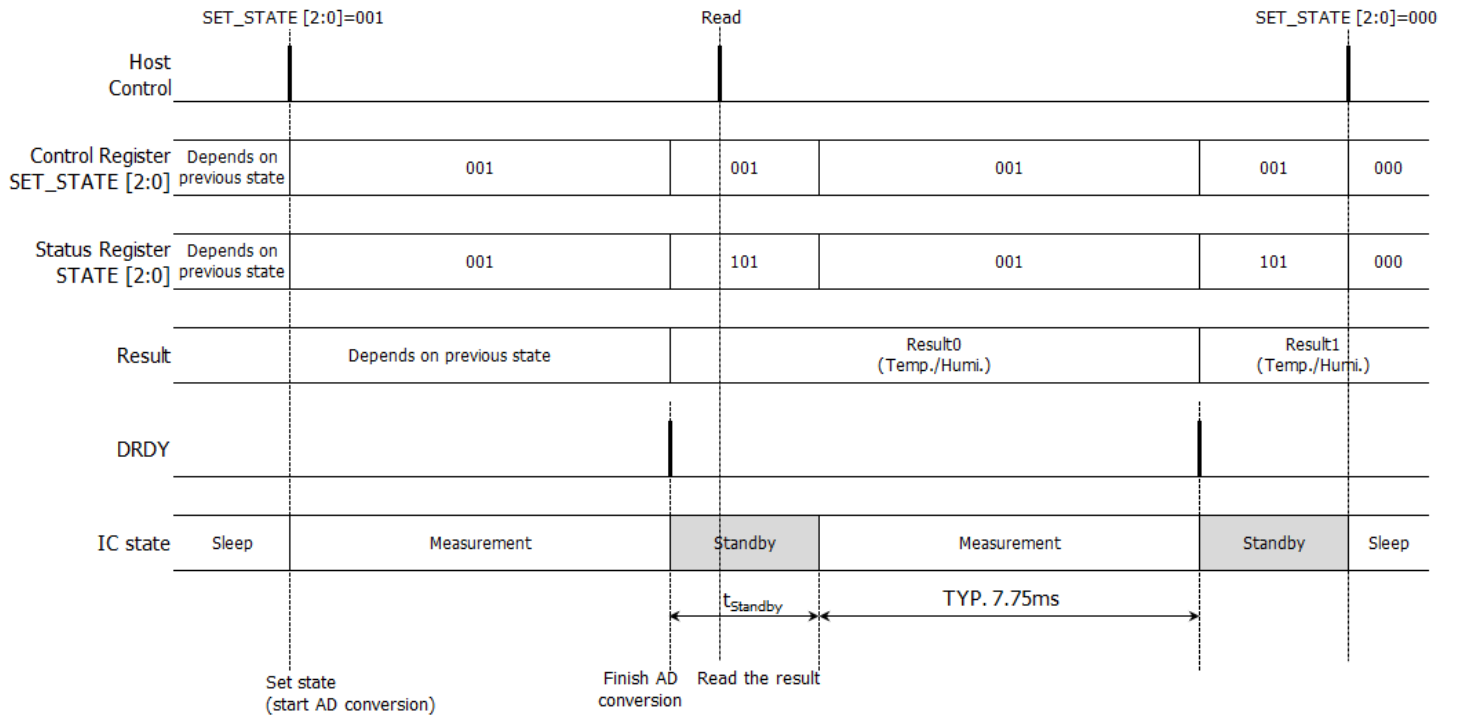

Fig.8 Timing chart for Repeat Operation

One Shot Operation

One Shot Operation is a single measure that automatically returns to sleep without transitioning to Standby state. Set the operation state setting bit SET_STATE [2:0] of the control register to 001b and Standby time setting bit TSTBY [2:0] to 111b. After the measurement is completed, the previous measurement results are discarded and the new measurement results are retained.

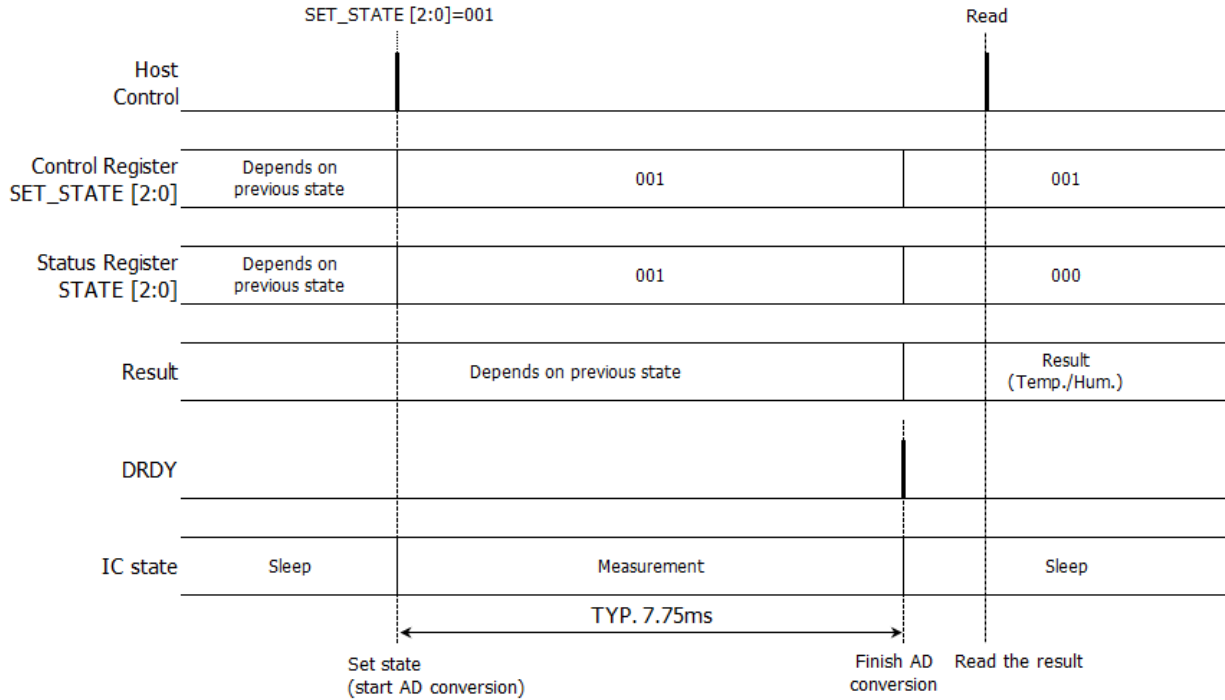

Fig.9 Timing chart for One Shot Operation

Heater function

MW3827 is equipped with a heater for functional verification. When the heater is enabled (EN_HEATER bit in the control register is 1b), it can be checked to see if it is functioning as a sensor by checking that the temperature is rising and the humidity is falling. Please wait about 20 seconds after activating the heater. Be careful not to forget to return the heater to OFF (EN_HEATER bit in the control register to 0b) after the operation check is finished. The initial value of EN_HEATER bit in the control register is 0b (Heater Off).

MW3827 is equipped with a function to detect abnormal heater current to prevent excessive heat generation. The ERR_HEAT bit in the status register indicates the monitoring result of the abnormal current of the heater.

State transition table

Table.3 State transition table

SET_STATE [2:0]	State		
	Sleep	Standby	Measurement
Sleep (000b)	Keep state	Transit to Sleep	After AD conversion, transit to Sleep
Measurement (001b) Repeat Operation	Transit to Measurement	Transit to Measurement	Keep state
Measurement (001b) One Shot Operation	Transits to Measurement, transits to Sleep after AD conversion	Transits to Measurement, transits to Sleep after AD conversion	Transits to Sleep after AD conversion
Reset & Sleep (100b)	After all register reset and Boot Load, transit to Sleep	After all register reset and Boot Load, transit to Sleep	After all register reset and Boot Load, transit to Sleep

When there is error in Boot Load, the MW3827 will be waiting in the sleep state, set ERR_BL "1". Please see [Status register](#) for details

State transition diagram

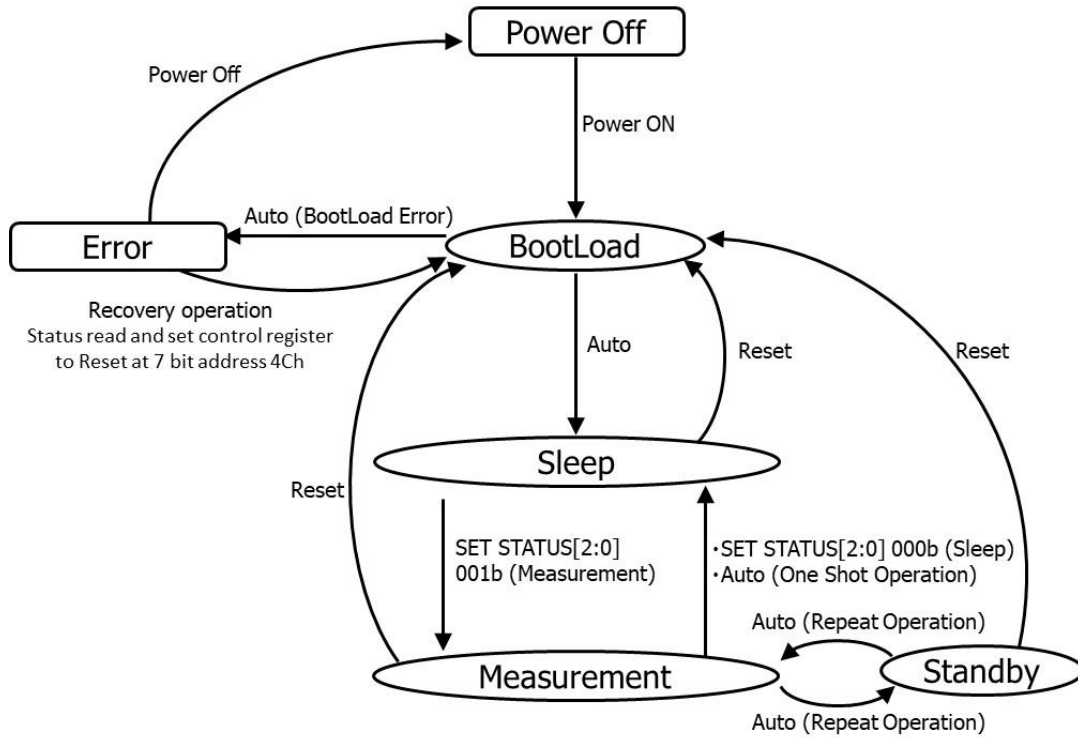

Fig.10 State transition diagram

Notes on transitioning from a Repeat Operation to another

When MW3827 is in Repeat operation and the device is accessed during the transition from Standby to Measurement, it returns an NACK as a communication error. If this happens, wait at least 3msec after a communication error occurs before accessing the device again.

Control register

Table.4 Detail of control register

Addr	Initial	Bit7	Bit6	Bit5	Bit4	Bit3	Bit2	Bit1	Bit0	R/W
0Ch	00h	Reserved	TSTBY[2:0]			EN HEATER	SET_STATE[2:0]			R/W
<p>●TSTBY[2:0] :</p> <p>Either 000b~110b is set T_{Standby} (Standby time) When SET_STATE [2:0] is set other than 001b, this setting is ignored.</p> <p>000b : For manufacturer (note⁶)</p> <p>001b : For manufacturer (note⁶)</p> <p>010b : T_{Standby} 100ms</p> <p>011b : T_{Standby} 400ms</p> <p>100b : T_{Standby} 1000ms</p> <p>101b : For manufacturer (note⁶)</p> <p>110b : For manufacturer (note⁶)</p> <p>111b : One Shot (Returns to Sleep without transit to Standby)</p> <p>●EN_HEATER :</p> <p>Set Heater On or Off. "0" is Heater-OFF. "1" is Heater-ON.</p> <p>●SET_STATE[2:0] :</p> <p>Set operation state.</p> <p>000b : Transit to "Sleep".</p> <p>001b : Transit to "Measurement".</p> <p>010b : Prohibited settings</p> <p>011b : For manufacturer (Test state) (note⁶)</p> <p>100b :Reset & Sleep Reset to initialize all registers, and then transit to Sleep.(note⁷)</p> <p>101b : For manufacturer (Test state) (note⁶)</p> <p>110b : For manufacturer (Test state) (note⁶)</p> <p>111b : Prohibited settings</p>										

**Important : Don't send data the other register in this specification sheet.
It could lead to operate out of specification**

note⁶: Setting for inspection. Be care not to set it. If it is set incorrectly, perform Reset & Sleep.

note⁷: After Reset & Sleep, wait for at least 3msec before accessing the device.

Status register

Table.5 Detail of status register

Addr	Initial	Bit7	Bit6	Bit5	Bit4	Bit3	Bit2	Bit1	Bit0	R/W
09h	00h	Reserved	ERR_HEAT	ERR_BL	ERR_INFO	RDY_DATA	STATE[2:0]			R/-

●ERR_HEAT :

Overcurrent detection signal for heater current. 0: Normal, 1: Abnormal

If an overcurrent flows when the heater is used (EN_HEATER=1), the heater operation is stopped and this bit is set to "1". (Overcurrent threshold is 140mA; design value.)

Clear condition: Reset & Sleep (SET_STATE[2:0]を 001b) or EN_HEATER=0

●ERR_BL :

NVM BootLoad error detection signal. 0: Normal, 1: Abnormal

When this signal becomes "1" (Abnormal), slave address (7-bit) is changed to "4Ch" and transit to error state.

Clear condition: Reset & Sleep (SET_STATE[2:0]001b) or being turned on again after power supply is cut off.

●ERR_INFO :

Signal informing prohibition setting of control register. 0: Normal, 1: Abnormal

If it is set to prohibit, it transits to sleep state without starting operation. At this time, the ERR_INFO bit of the status register becomes "1".

Clear condition: Writing the correct settings starts normal operation. At that time, ERR_INFO is set to "0".

●RDY_DATA :

Signal determining acquisition of conversion result.

This bit becomes "0" at the time of conversion setting and "1" after conversion completion. This bit is cleared to "0" by reading the result or Reset & Sleep when this bit is "1".

●STATE[2:0] :

Represents MW3827 state.

000b : Sleep

001b : Measurement (Repeat Operation or One Shot Operation)

010b, 011b : For manufacturer

In normal operation, this state is not entered. If this condition stops, Reset & Sleep MW3827 or being turned on again after power supply is cut off.

100b : None

101b : Standby (Temporary state)

110b : For manufacturer

111b : None

Method of calculation to temperature and humidity values

The read digital value is the corrected value that is automatically performed for each AD conversion. Therefore, the user can obtain the temperature and humidity using the formula shown below.

$$\text{Temperature} = (16\text{-bit digital value} - 2^{15}) / 50 + 25 \quad [^{\circ}\text{C}]$$

$$\text{Humidity} = 1000 * (16\text{-bit digital value} - 2^{15}) / 2^{18} - 20 \quad [\%RH]$$

■Example for temperature calculation

$$\begin{aligned} \text{Temperature} &= (34003 - 2^{15}) / 50 + 25 \\ &= (+1235) / 50 + 25 \\ &= (24.7) + 25 \\ &= 49.70 [^{\circ}\text{C}] \end{aligned}$$

■Example for humidity calculation

$$\begin{aligned} \text{Humidity} &= 1000 * (51118 - 2^{15}) / 2^{18} - 20 \\ &= 1000 * (+18350) / 2^{18} - 20 \\ &= (69.9997) - 20 \\ &= 49.9997 [\%RH] \end{aligned}$$

Table.6 Correspondence table between 16-bit digital value and temperature

16-bit digital value	16-bit digital value - 2 ¹⁵	Temperature [°C]
65535 (FFFFh)	32767 (7FFFh)	680.34
32769 (8001h)	1 (0001h)	25.02
32768 (8000h)	0 (0000h)	25.00
32767 (7FFFh)	-1 (FFFFh)	24.98
0 (0000h)	-32768 (8000h)	-630.36

Table.7 Correspondence table between 16-bit digital value and humidity

16-bit digital value	16-bit digital value - 2 ¹⁵	Humidity [%RH]
65535 (FFFFh)	32767 (7FFFh)	104.9962
64225 (FAE1h)	31452 (7AE1h)	99.9989
51118 (C7AEh)	18350 (47AEh)	49.9997
38011 (947Bh)	5243 (147Bh)	0.0005
32769 (8001h)	1 (0001h)	-19.9962
32768 (8000h)	0 (0000h)	-20.0000
32767 (7FFFh)	-1 (FFFFh)	-20.0038
0 (0000h)	-32768 (8000h)	-145.0000

SERIAL INTERFACE

The MW3827 supports I²C of Fast mode (fmax = 400kHz) as an interface for serial communication.

I²C format

The I²C address is 8-bit, including the slave address of the first 7-bits and R/W bit of the remaining 1-bit. Slave address for the MW3827 (7-bit) is 28h. I²C address (8-bit) will be 50h (Write) and 51h (Read) by combining with R/W bit.

Table.8 I²C address

HEX.	I ² C Address (8-bit)							R/W bit
	Slave address (7-bit)							
	A6	A5	A4	A3	A2	A1	A0	
50h	0	1	0	1	0	0	0	0
51h	0	1	0	1	0	0	0	1

Write format

This format is used to set the control register (0Ch). Start by sending 8-bit I²C address 50h (Write). After the address is received, ACK is returned to the 9th bit. After that, send 8-bit control register address (0Ch). After the register address is received, ACK is returned to the 9th bit. Then, send 8-bit data according to the control register details.

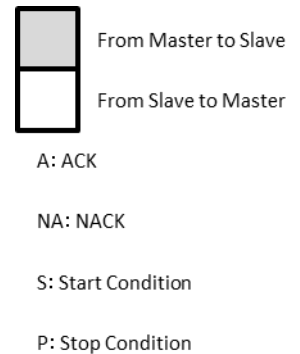
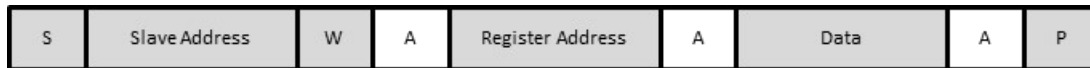

Fig.11 Write format

Important : Don't send data the other register in this specification sheet. It could lead to operate out of specification

Read format

This format is used to read measurement results of temperature and humidity. Start by sending 8-bit I²C address 51h (Read). After the address is received, ACK is returned to the 9th bit. After that, 32-bit data is output in 8-bit units in MSB first. Then, send ACK every 8-bit. As shown, Humi.Data is 16-bit of [15:0] and Temp.Data is 16-bit of [15:0]. It is unnecessary to send register address.

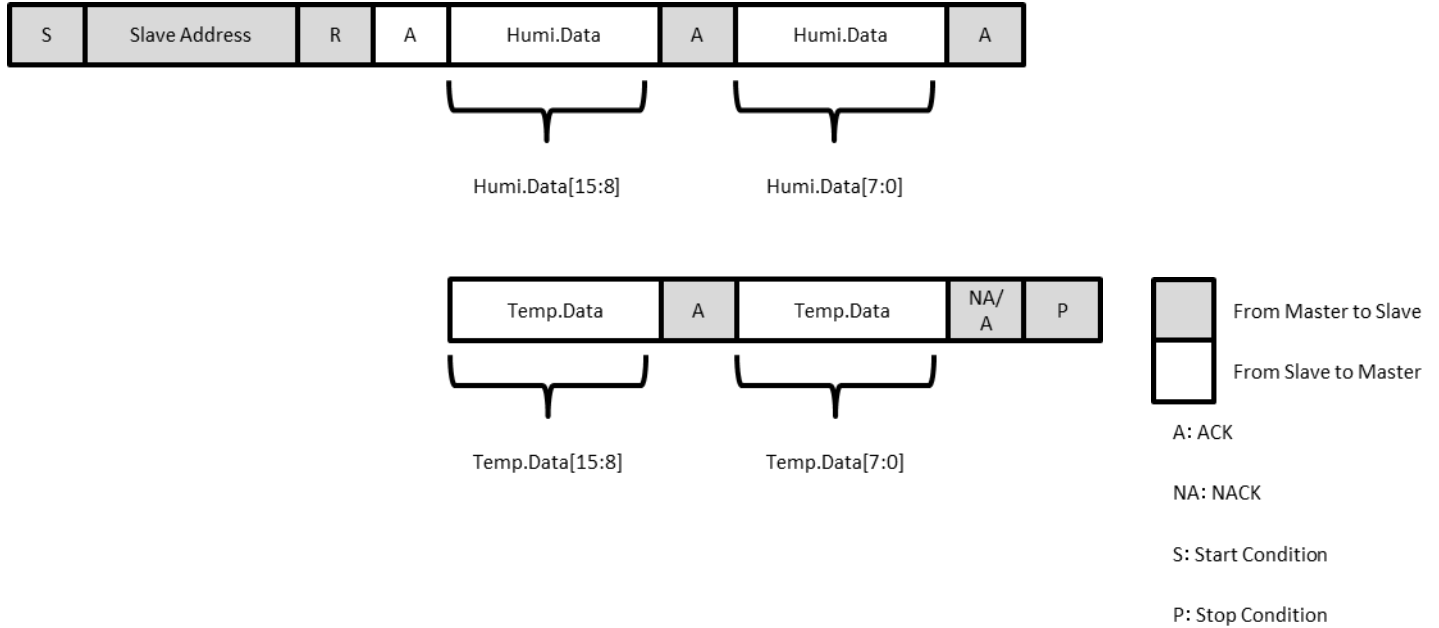

Fig.12 Read format

Combined format

This format is used to read register value. Start by sending 8-bit I²C address 50h (Write). After the address is received, ACK is returned to the 9th bit. After that, send an 8-bit control register address (0Ch) or status register address (09h). The MW3827 will respond with ACK with 9th bit. Then, send 8-bit I²C address 51h (Read). After the address is received, ACK is returned to the 9th bit and 8-bit data is output. For details of register, refer to [Control register](#) or [Status register](#).

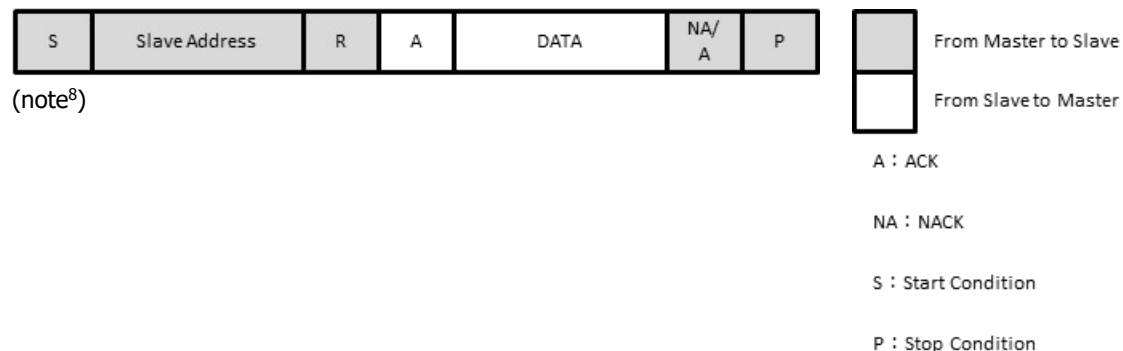
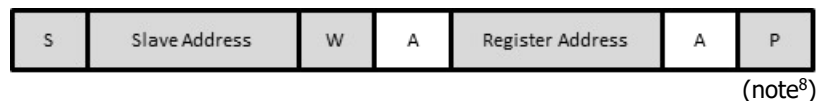

Fig.13 Combined format

note⁸: It also supports Repeat start condition.

I²C AC characteristics

※Design assurance items

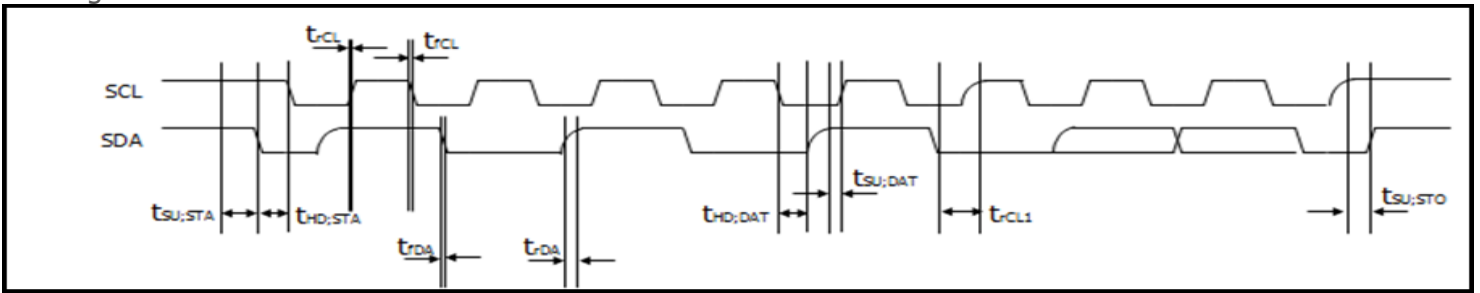

Fig.14 I²C AC timing chart

Table.9 I²C AC Characteristics (note⁹)

(Unless otherwise specified, $T_a=25^\circ\text{C}$, $V_{DD}=3.3\text{V}$, $C_{OL}\leq 400\text{pF}$)

Items	Symbol	Fast mode			Unit
		min	Typ	max	
SCL clock frequency	f_{SCL}	0	-	400	kHz
Start condition setup time relative to SCL edge	$t_{SU:STA}$	600	-	-	ns
Start condition hold time relative to SCL edge	$t_{HD:STA}$	600	-	-	ns
Stop condition setup time on SCL	$t_{SU:STO}$	600	-	-	ns
Data setup time on SDA relative to SCL edge	$t_{SU:DAT}$	100	-	-	ns
Data hold time on SDA relative to SCL edge	$t_{HD:DAT}$	20	-	-	ns
SCL rise time	t_{rCL}	-	-	300	ns
SCL fall time	t_{fCL}	10	-	300	ns
SDA rise time	t_{rDA}	-	-	300	ns
SDA fall time	t_{fDA}	10	-	300	ns

note⁹: This product does not have the function to retain data in SDA. Please ensure the hold of SDA with 20nsec for the area where SCL falling edge is not defined.

TYPICAL APPLICATION CIRCUIT

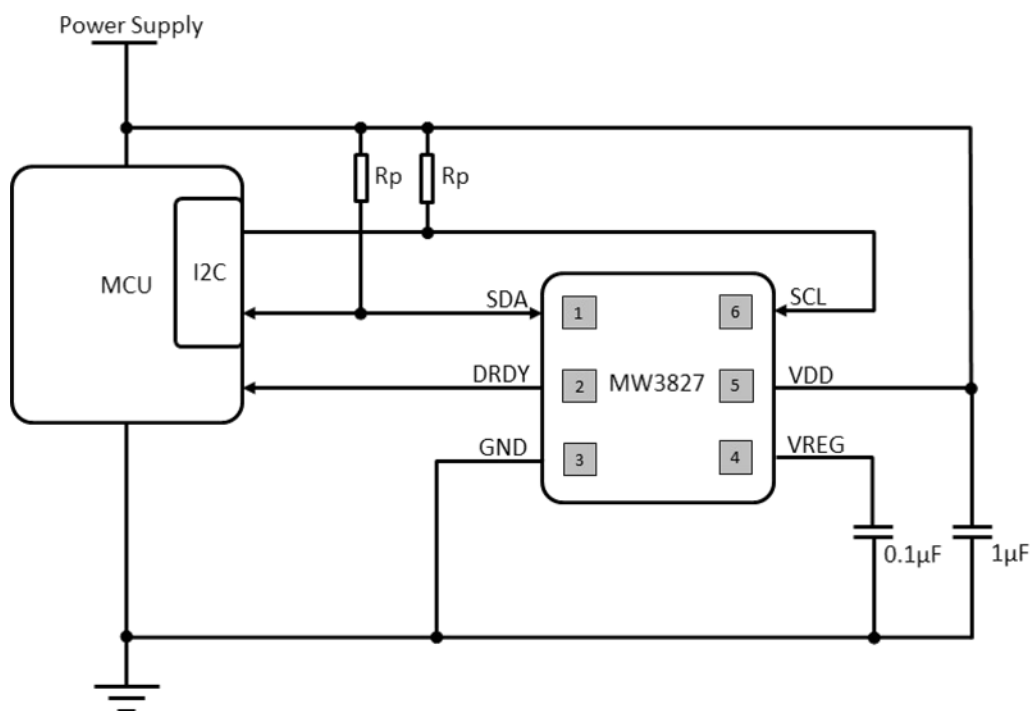

Fig.15 Typical electrical connection

TYPICAL PERFORMANCE CHARACTERISTICS

(Unless otherwise specified, $T_a=25^\circ\text{C}$, $V_{DD}=3.3\text{V}$)

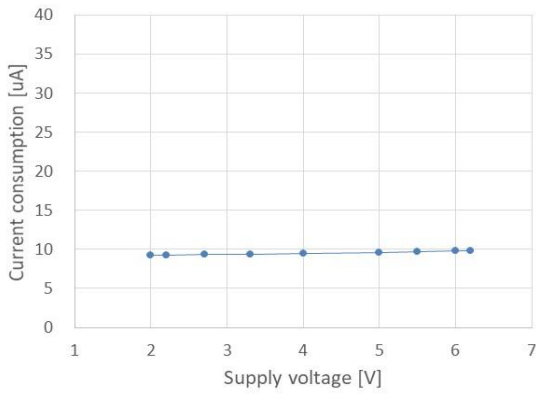

Fig.16 Current consumption I_{DD} Supply voltage characteristics

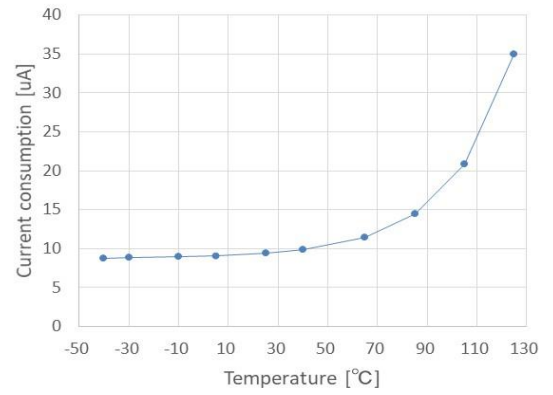

Fig.17 Current consumption I_{DD} Temperature characteristics

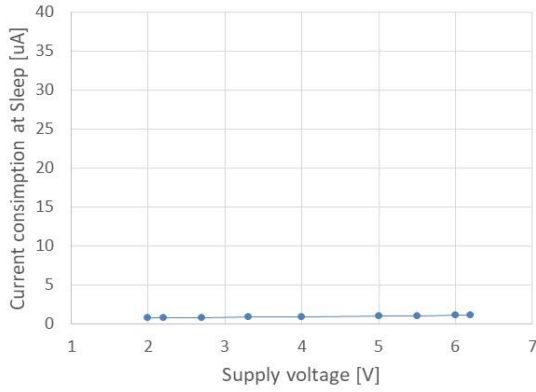

Fig.18 Current consumption at Sleep I_{DDSL} Supply voltage characteristics

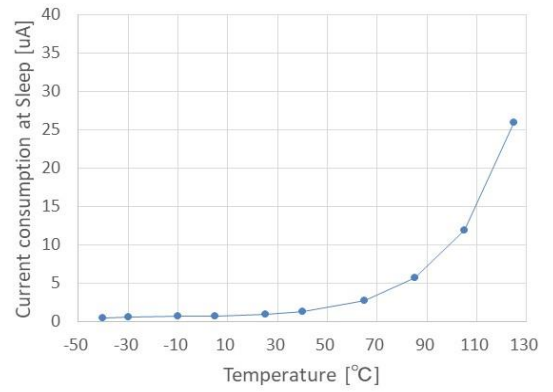

Fig.19 Current consumption at Sleep I_{DDSL} Temperature characteristics

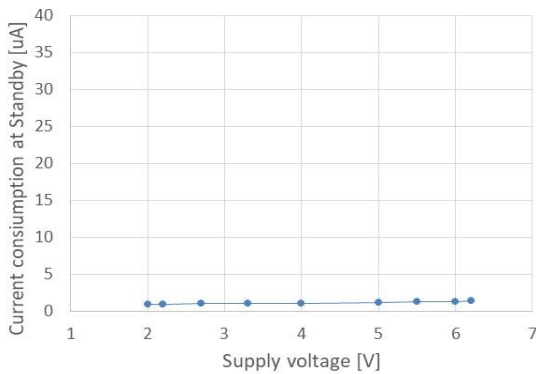

Fig.20 Current consumption at Standby I_{DDSB} Supply voltage characteristics

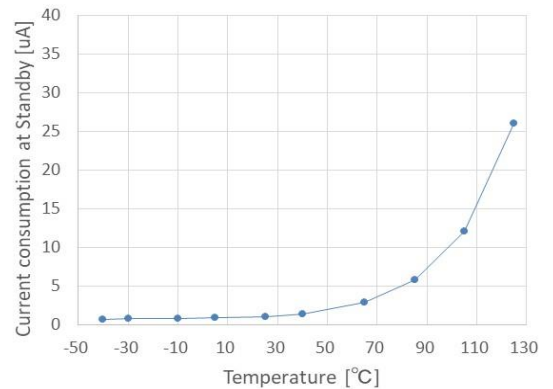

Fig.21 Current consumption at Standby I_{DDSB} Temperature characteristics

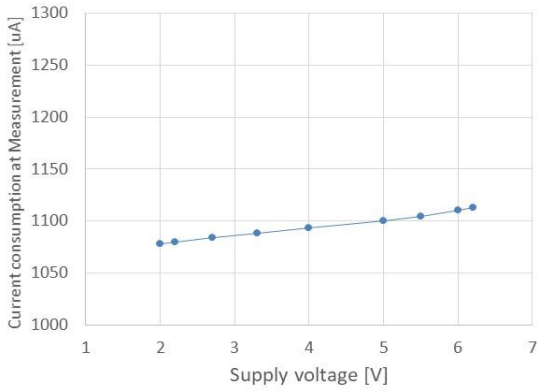

Fig.21 Current consumption at Measurement I_{DDM} Supply voltage characteristics

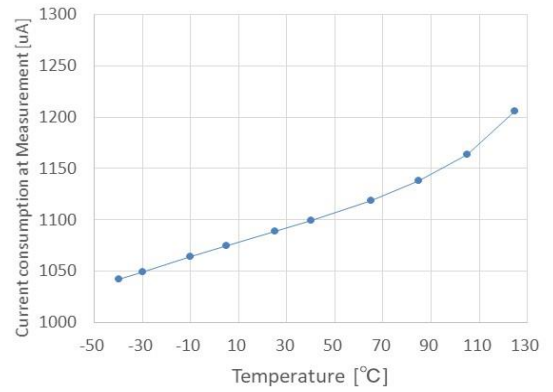

Fig.22 Current consumption at Measurement I_{DDM} Temperature characteristics

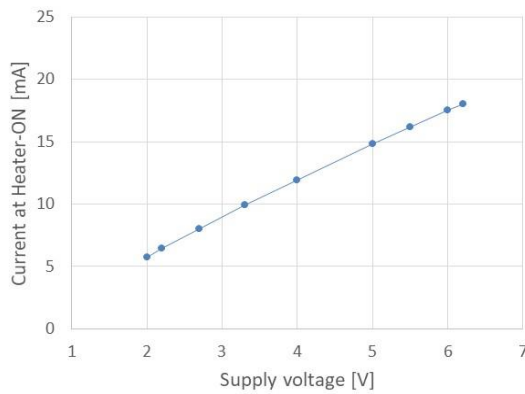

Fig.23 Current at Heater-ON I_{HEAT} Supply voltage characteristics

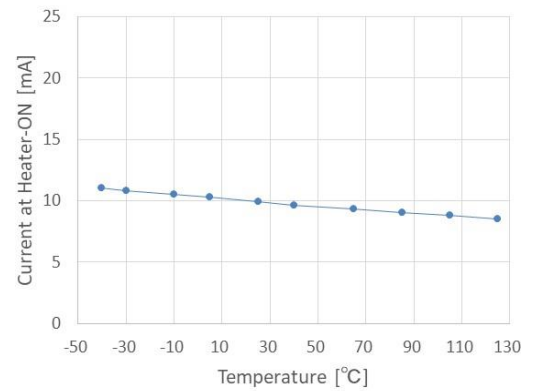

Fig.24 Current at Heater-ON I_{HEAT} Temperature characteristics

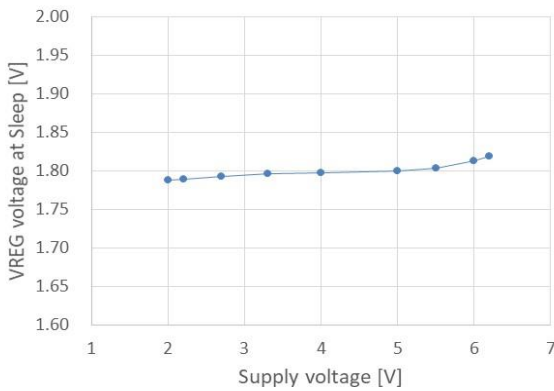

Fig.25 VREG voltage at Sleep V_{RGSL} Supply voltage characteristics

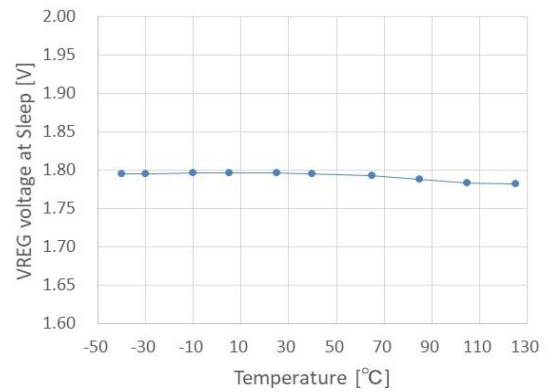

Fig.26 VREG voltage V_{RGSL} Temperature characteristics

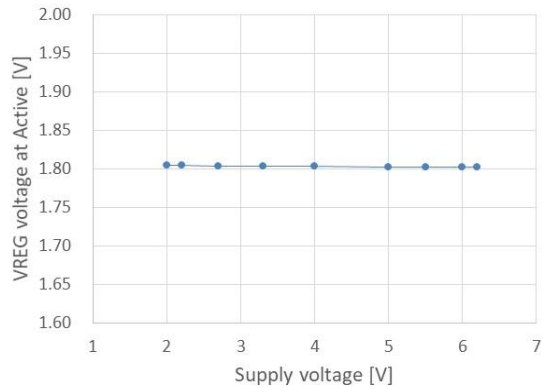

Fig.27 VREG voltage V_{RGACT}
Supply voltage characteristics

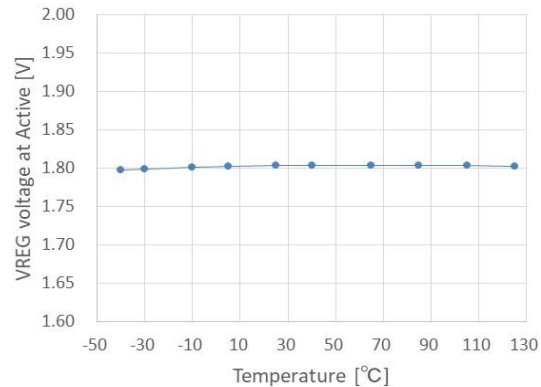
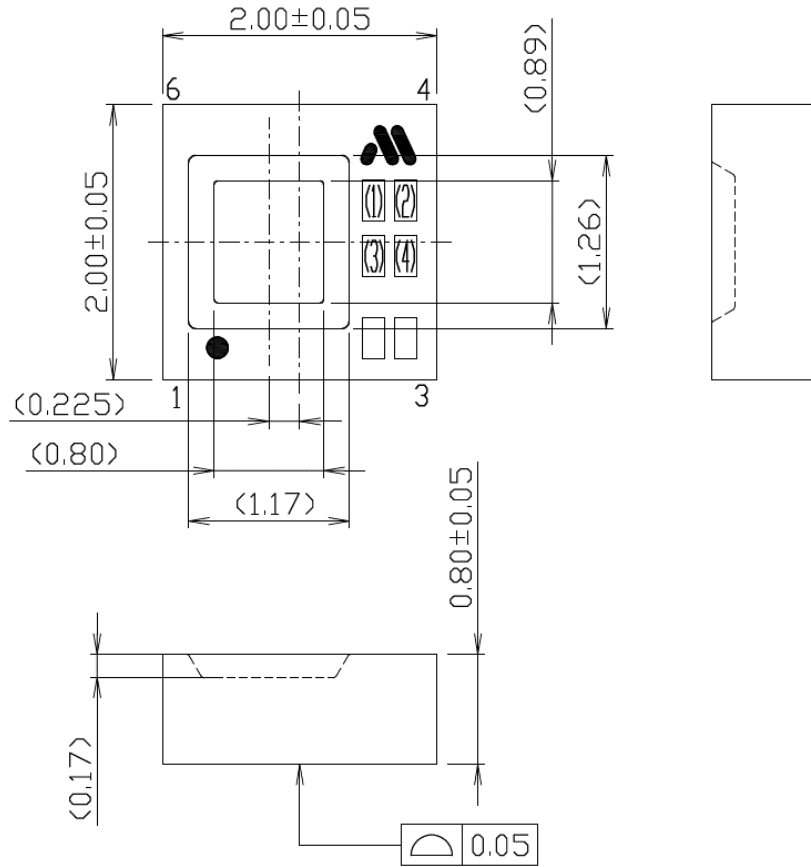

Fig.28 VREG voltage V_{RGACT}
Temperature characteristics

DIMENSIONS

PACKAGE : PLP-6L

UNIT	mm
------	----



裏面 (Bottom View)

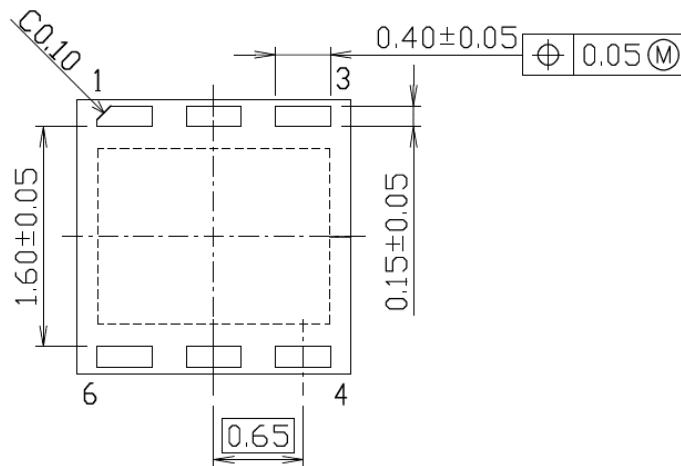

MARKING CONTENTS

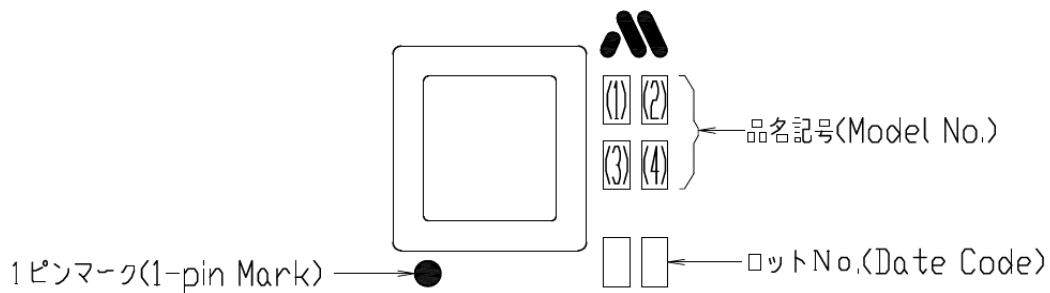

Model name	Model No.			
	(1)	(2)	(3)	(4)
MW3827	3	8	2	7

How to identify 2 characteristics lot numbers.



(1) The 1st digit (①) shows the first half of the year or the latter half.

(2) The 2nd digit (②) shows a production week of mass production.

【How to indicate a production year】

First half of the year

The 1st digit (①)	
The last digit of a production year	Mark
xxx1	1
xxx2	2
xxx3	3
xxx4	4
xxx5	5
xxx6	6
xxx7	7
xxx8	8
Xxx9	9
Xxx0	0

The 2nd digit (②)			
Production week	Mark	Production week	Mark
1	1	14	E
2	2	15	F
3	3	16	G
4	4	17	H
5	5	18	J
6	6	19	K
7	7	20	L
8	8	21	M
9	9	22	N
10	A	23	P
11	B	24	Q
12	C	25	R
13	D	26	S

Last half of the year

The 1st digit (①)	
The last digit of a production year	Mark
xxx1	A
xxx2	B
xxx3	C
xxx4	D
xxx5	E
xxx6	F
xxx7	G
xxx8	H
Xxx9	J
Xxx0	K

The 2nd digit (②)			
Production week	Mark	Production week	Mark
27	1	40	E
28	2	41	F
29	3	42	G
30	4	43	H
31	5	44	J
32	6	45	K
33	7	46	L
34	8	47	M
35	9	48	N
36	A	49	P
37	B	50	Q
38	C	51	R
39	D	52	S
		53	T

CONDITION FOR PACKAGE MOUNTING

Design example of mount pad

UNIT	mm
------	----

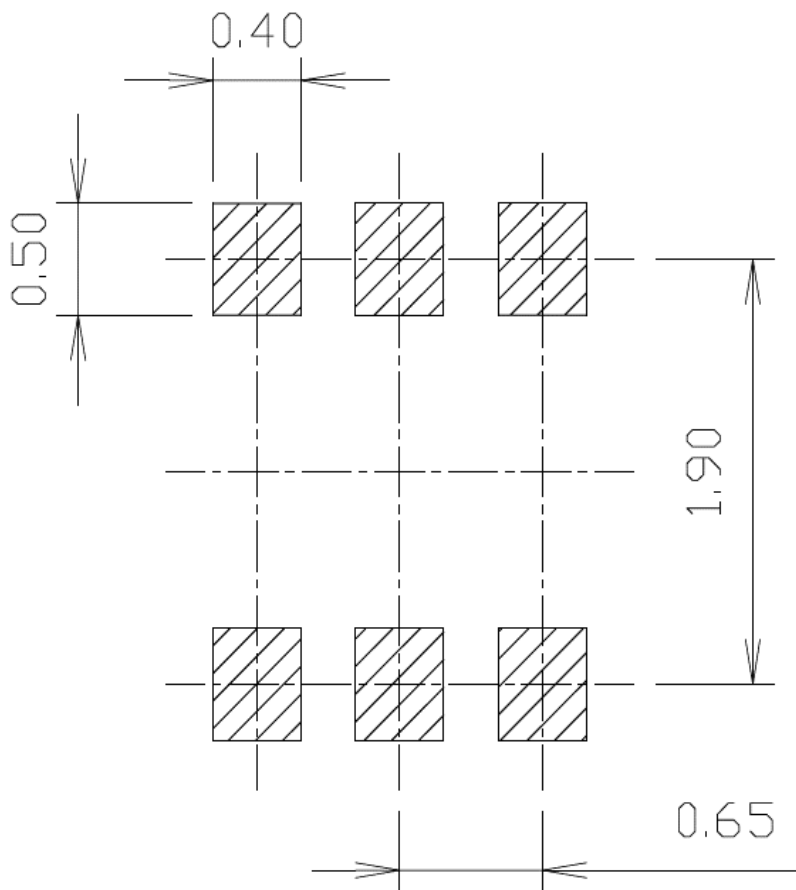

The dimension is for reference only and not guaranteed by design.

To design practically, correction should be made for optimized dimensions considering the effects of the board type to be mounted, mount (soldering) method, type and coating thickness of cream solder.

Pb-Free recommended profile condition

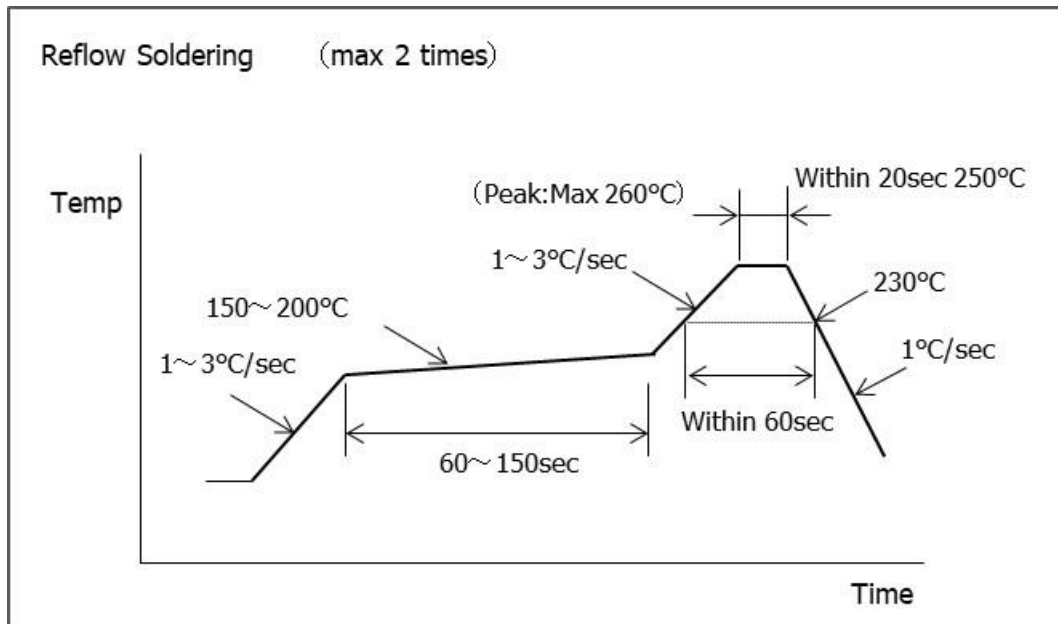

This profile gives recommended values, which are not guaranteed. For mounting the package, evaluate the profile with the equipment, conditions, and materials to be used.

This IC does not support cleaning because the temperature & humidity sensor is exposed on the surface of the package. Therefore, please use a non-cleaning type solder paste for mounting.

- Mounting by wave soldering
Wave soldering cannot be used for mounting of this package.
- Mounting by manual soldering
Manual soldering cannot be used for mounting of this package.

Rehydration treatment

It is recommended to perform rehydration treatment after reflow mounting.

Rehydration conditions : 85°C85%RH6hrs

Storage method

【Storage condition】

Store the device under the following conditions.

Temperature	: 5~30°C
Humidity	: 40~70%RH
Storage life	: 1year

If stored in an environment that exceeds the storage conditions, the characteristics may change. Store the product in the original packing bag. For storage after mounting the product, use an ESD bag with a metal layer. Do not use polyethylene ESD bags as they may change characteristics. Do not store this device where a large amount of dust or harmful volatile gas exists, electrostatic is easily charged, condensation is generated, or changes in temperature and humidity are wide, or under the direct sunlight.

【Baking】

If the storage time specified above has passed, mounting by soldering may cause cracks on the moisture absorbed package. Before mounting, the package should be baked under the following conditions. Because the moisture content of the product changes due to heat during baking and reflow, be sure to perform the rehydration treatment after mounting.

Temperature	:125°C
Treating time	:16~24hours

Embossing tapes and reels are not heat-resistant type.

Before baking, the device should be placed in a heat-resistant container.

In consideration of the time-consuming baking process and the possibility of deformed terminal, the device should be mounted promptly within the time observing the storage conditions.

【Handling instructions】

Shipping boxes must be handled with care because any drop or shock may damage the device.

Additionally, the device must be handled in the place with the protection against electrostatic charge and without extreme changes of temperature/humidity.

Be careful not to touch the package opening with fingers. The characteristics may fluctuate due to oils in skin.

Note that the characteristics may fluctuate if salt adheres to the package opening.

【Instructions for mounting】

When this product is mounted on the board, the effect from the board may depend on the product mounting direction and position. Board stress (warping, bending, etc.) and mechanical stress (vibration, impact, etc.) may cause fluctuation of electrical characteristics, package crack, chip crack, loss of lead, and others. Therefore, if the effect of the stress is a concern as shown in Figure A, it is recommended to mount this product on the board as shown in Figure B or C.

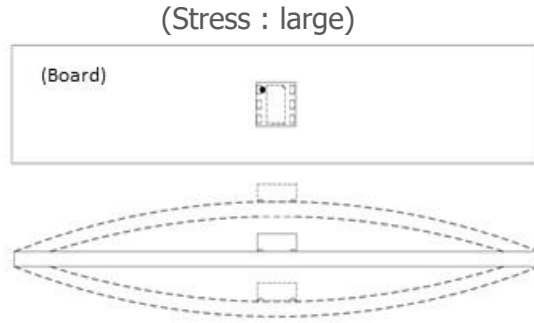

Figure A Mounting susceptible to the effect of the stress

When this product (lead direction) is mounted in a horizontal direction to a long side of the board, the stress from the board significantly affects leads.

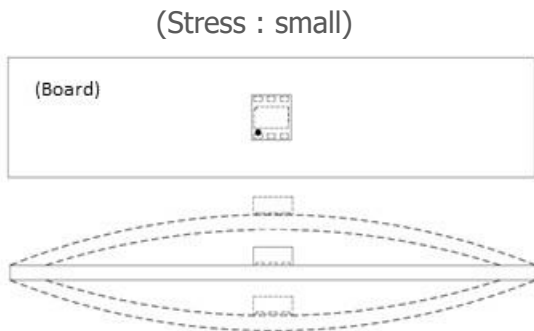

Figure B Mounting condition with less stress
(Mounting direction)

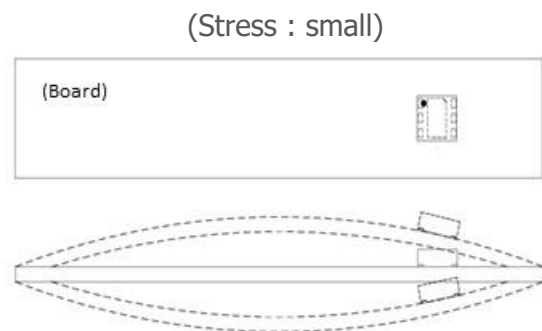

Figure C Mounting condition with less stress
(Mounting position)

Mounting the product (lead direction) perpendicular to a long side of the board reduces the effect of the stress from the board on the leads.

Mounting the product in a position away from the board center reduces the effect of the stress from the board on the leads.

Before mounting this product on the board, fully examine other conditions including the radiation performance and mechanical strength of the board as well.

PACKAGING SPECIFICATION

1. APPLICATION LIMIT

IT APPLIES TO THE PACKING SPECIFICATION OF PLP-6L.

2. QUANTITY

(1) REEL PACKING 4000pcs / REEL

(2) BOX PACKING MAX 20,000 pcs / BOX (5 REEL)

THE QUANTITY IS FILLED IN THE PACKING SLIP.

3. PACKING SPECIFICATION

(1) HOUSING SPECIFICATION REFER TO DRAWING

(2) REEL DIMENSIONS REFER TO DRAWING

(3) BOX DIMENSIONS REFER TO DRAWING

エンボステープ収納仕様

EMBOSS TAPE HOUSING SPECIFICATION

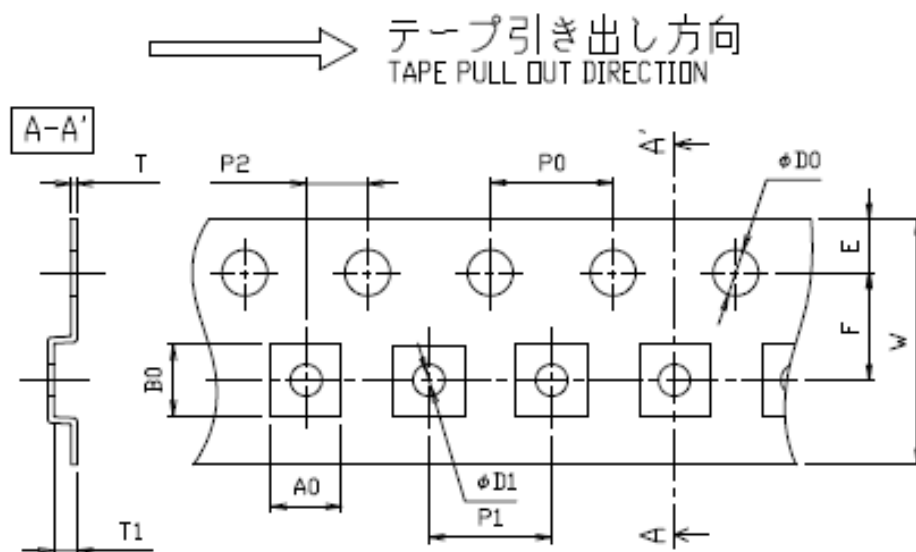

記号 SYS.	A0	B0	W	F	E	P1	P2	P0	$\phi D0$	T	T1	$\phi D1$
UNIT mm	2.3	2.3	8.0	3.5	1.75	4.0	2.0	4.0	1.5	0.2	1.0	1.05
	± 0.05	± 0.05	± 0.1	± 0.05	± 0.1	± 0.1	± 0.05	± 0.1	$^{+0.1}_{-0}$	± 0.05	± 0.05	± 0.05

NOTE

1. 部品の引き出し方向
IC PULL OUT DIRECTION

R収納
R HOUSING

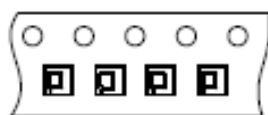

L収納
L HOUSING

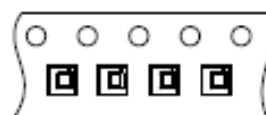

2. キャリアテープの材質は、帯電防止処理済みとする。
CARRIER TAPE MATERIAL : DISPOSED ELECTRICATION PREVENTION.
3. リーダー部のテープの長さは、部品が入っていないエンボスを40以上
含み、200mm以上とする。
LENGTH OF LEADER TAPE : MORE THAN 200mm INCLUDING 40 OR MORE
EMBOSES IN WHICH NO COMPONENT IS PLACED.
4. 終端部のテープの長さは、部品が入っていないエンボスを40以上
含み、160mm以上とする。
LENGTH OF TRAILER TAPE : MORE THAN 160mm INCLUDING 40 OR MORE
EMBOSES IN WHICH NO COMPONENT IS PLACED.

リール寸法
REEL DIMENSIONS

UNIT mm

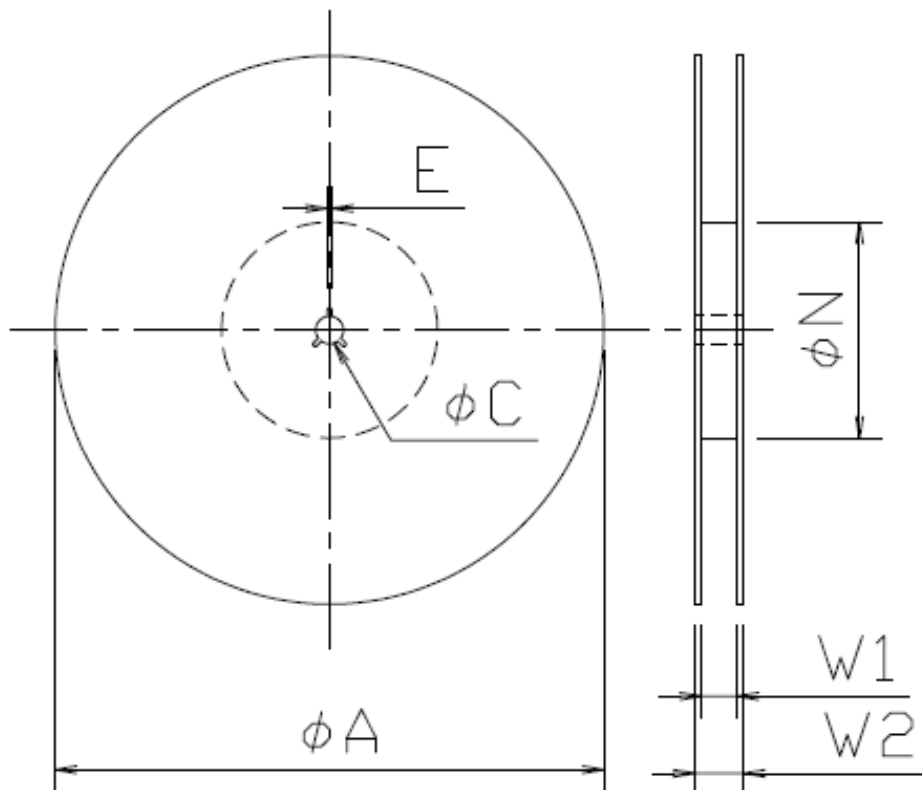

記号 SYM.	φA	φC	φN	E	W1	W2
UNIT	180	13	60	2	9.0	11.4
mm	$\pm \frac{0}{3}$	± 0.2	$\pm \frac{1}{0}$	± 0.5	$\pm \frac{1}{0}$	± 1.0

箱寸法
BOX DIMENSIONS

UNIT mm

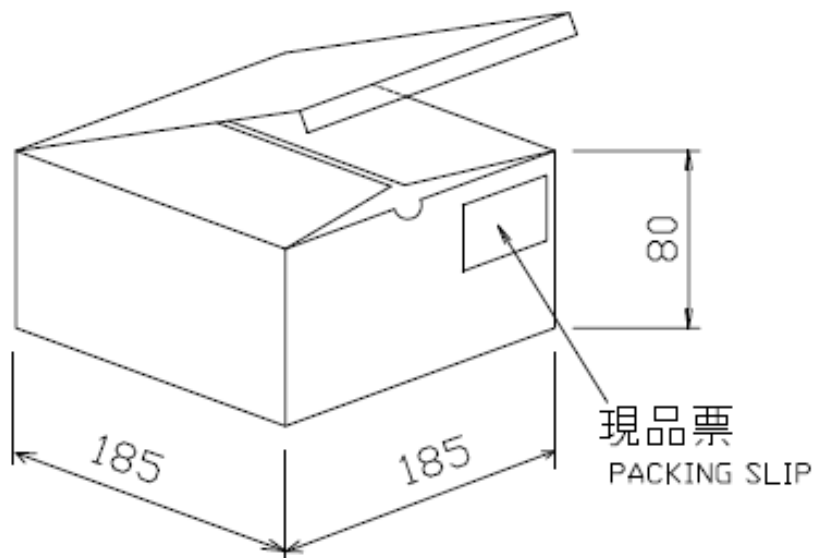

現品票
PACKING SLIP

MITSUMI ELECTRIC CO., LTD. 現品票 PACKING SLIP	
納入先 MESSRS	
品番 PART NO.	
品名 DESCRIPTION	
生産 P/O NO.	
特記 NOTE	
TOTAL Q'TY/BOXES Q'TY/BOX	
数量	個入
DATE	備
LOT NO.	
尺書 SPEC. R.	

MITSUMI ELECTRIC CO.,LTD.

Strategy Engineering Department Semiconductor Business Division

Tel: +81-46-230-3470 / <http://www.mitsumi.co.jp>

Notes:

Any products mentioned this datasheet are subject to any modification in their appearance and others for improvements without prior notification. The details listed here are not a guarantee of the individual products at the time of ordering. When using the products, you will be asked to check their specifications.