

SM0006-170-NB



APPLICATIONS

- Wind Turbine Pitch Control
- Engineering Machinery
- Industrial Equipment
- UPS and Telecom Systems



FEATURES & ADVANTAGES

- One Million Cycle Life
- High Power Density
- Voltage Monitoring
- Wide Temperature Range: -50°C to +65°C



Specifications

Capacitance	Rated ¹	6F
	Tolerance	-0/+20%
Voltage	Rated	170V DC
	Surge ²	186V DC
ESR	ESR (DC) - maximum initial	200mΩ
Current	Maximum leakage ³	25mA
	Maximum peak	214A
	Maximum continuous (ΔT = 15°C)	7A RMS
	Maximum continuous (ΔT = 40°C)	13A RMS
Energy Storage	Maximum energy ⁴	24.1Wh
	Usable energy ⁵	18.1Wh
	Volumetric energy density ⁶	3.5Wh/L
	Gravametric energy density ⁷	4.6Wh/kg
Power	Power density ⁸	3335W/kg

Temperature

Temperature Characteristics	Operating temperature range	-40°C to +65°C
	Storage temperature range	-40°C to +70°C

Monitor and Control

Alarm Monitor	Over voltage	YES
	Temperature sensor	N/A

Safety

Safety	Short circuit current	8100A
	500V DC Insulation resistance	≥100MΩ
	5600V DC Leakage current	≤10mA
	Environmental ingress protection	IP54

Service Lifetime

Endurance	Product held at rated voltage in 65°C environment for 1500 hours	
	Change in capacitance (% drop from rated)	≤20%
	Change in ESR (% increase from maximum initial)	≤100%
DC Life	Product held at rated voltage in 25°C environment	
	Life (projected)	10+ years
	Change in capacitance (% drop from rated)	≤20%
	Change in ESR (% increase from maximum initial)	≤100%
Cycle Life	Cycling from rated voltage to 50% voltage under constant current in 25°C environment	
	Life (projected)	1,000,000 cycles
	Change in capacitance (% drop from rated)	≤20%
	Change in ESR (% increase from maximum initial)	≤100%
Storage	Stored uncharged in original packaging in 25°C environment	
	Life	4 years

Physical Characteristics

Mechanical	Vibration	GB/T 11287-2000
	Transportation vibration	GB/T 4798.2-2008
	Shock	GB/T 14537-1993

Outline Drawings:

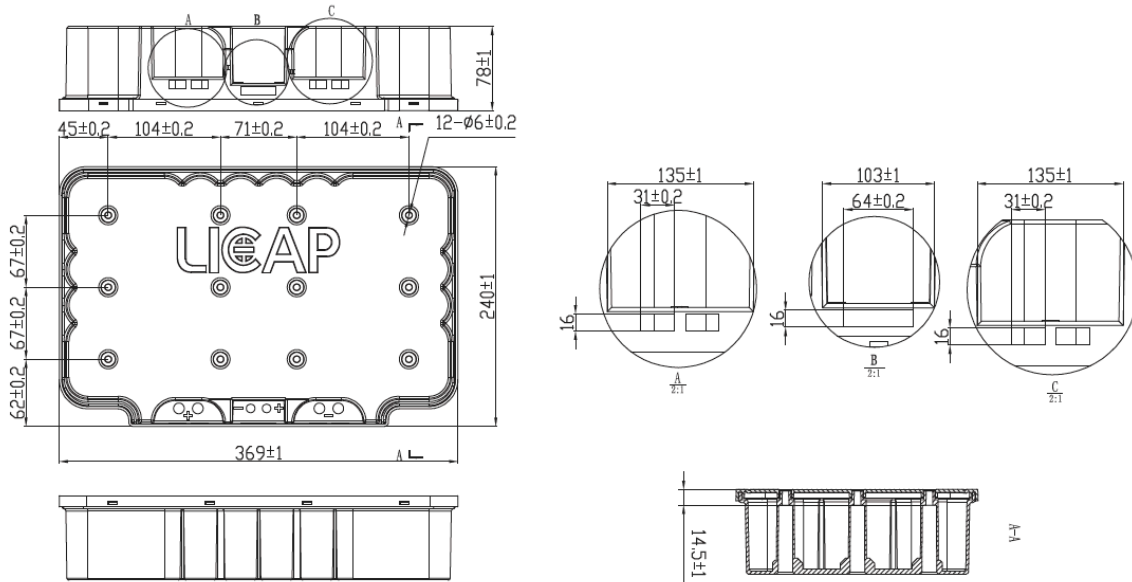

Weight and Size:

Weight: ≤5.2 kg | **Size:** (Typical value): 369*240*78 (L*W*H) mm

Naming Rules:

Type	Capacitance	Dash	Rated Voltage	Dash	CMS - Capacitor Management/Monitoring
SM Supercapacitor Module	0006 = 6F	-	0170 = 170V	-	NB = No balance

Notes:

1. Measure capacitance and DC internal resistance at 25°C under specified test current per Figure 1
2. Maximum voltage is non-repeatable and duration cannot exceed 1s
3. Corresponding current value after 72 hours of rated voltage at 25°C

$$4. 0.5C(V_{nom}^2)/3600$$

$$5. 0.5C(V_{nom}^2 - 0.5V_{nom}^2)/3600$$

$$6. \text{Max energy (Wh)} / \left(\frac{L \times W \times H \text{ (mm)}}{1 \times 10^6} \right)$$

$$7. \text{Max energy (Wh)} / \text{Weight (kg)}$$

$$8. \text{Per IEC62391-2, } P_d = \frac{0.12V^2}{ESR_{DC} \times \text{Weight(kg)}}$$

CAP/ESR Measurement Waveform

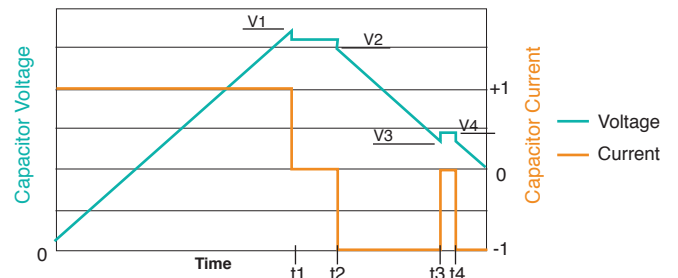

$$V1 = V_{rated} \quad t2 - t1 = 15 \text{ seconds} \quad \text{Capacitance} = I \times (t3 - t2) / (V2 - V3)$$

$$V3 = 0.5 \times V_{rated} \quad t4 - t3 = 5 \text{ seconds} \quad \text{ESR} = (V4 - V3) / I$$

Figure 1

Precautions:

- This product may vent or rupture if overcharged, reverse charged, incinerated or heated above 100°C
- Do not crush, mutilate, or disassemble
- Do not dispose of unit in trash

Specifications are subject to change without notice.