

40 Amp Power PCB Relay

PTRD-T

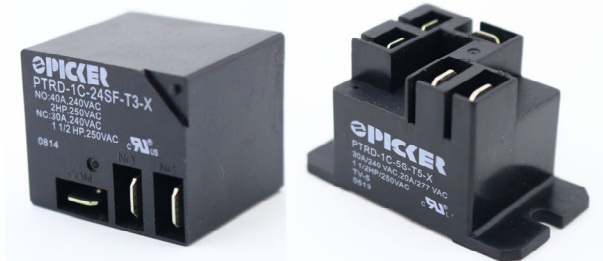

T2 & T3

T4 & T5

UL / CUL Ratings

cULus E93379

Load Type	Voltage	Cycles	1 Form A (SPST-NO)	1 Form B (SPDT-NC)	1 Form C (SPDT)	
					NO	NC
General Purpose	240 VAC	6,000	30 A	20 A	30 A	20 A
	277 VAC	6,000	30 A	20 A	30 A	20 A
	280 VAC	6,000	5 A	5 A	5 A	5 A
Resistive	240 VAC	250,000	40 A	30 A	40 A	30 A
	240 VAC		20 A	—	20 A	—
	277 VAC	100,000	25 A	—	25 A	—
	30 VDC	—	40 A	30 A	40 A	30 A
Motor	250 VAC	30,000	2 HP	1.5 HP	2 HP	1.5 HP
	120 VAC	30,000	1 HP	—	1 HP	—
Ballast	280 VAC	6,000	5 A	5 A	5 A	5 A

Additional UL / CUL Ratings for AgSnO Contacts

Load Type	Voltage	Cycles	Temp.	1 Form A (SPST-NO)	1 Form C (SPDT-NO)
Resistive	277/250 VAC	30,000	40°C	30 A	30 A

FEATURES

- Popular Power PCB Relay Footprint - T90
- 40 Amp 250 VAC General Purpose UL Rating
- 2 HP 250 VAC Rating
- Two Versions:
 - ◆ T2 (1A), T3 (1C) PC Pins & QC Pins
 - ◆ T4 (1A), T5 (1C) QC Pins with Mounting Tabs
- UL Class F Insulation Standard
- IP67 Epoxy Sealed Version Available
- Meets UL 508 and UL 873 Spacing
- RoHS Compliant

CONTACT DATA

Material	AgCdO, AgSnO ₂ In ₂ O ₃ , AgCdO+Au	
Initial Contact Resistance	50 mΩ Max. @ 1 A, 6 VDC	
Maximum Switching Voltage	110 VDC, 300 VAC	
Maximum Switching Current	40 A	
Maximum Switching Power	1200 W, 10,000 VA	
Service Life	Mechanical	1 X 10 ⁷ Operations
	Electrical	5 X 10 ⁴ Operations

Meets UL 508 and UL 873 Spacing - 3.18 mm Through Air, 6.36 mm Over Surface.

CHARACTERISTICS

Shock Resistance	200 m/s, 11 ms
Dielectric Strength	50 Hz 2,500 V 1 Min Between Coil and Contacts
	4,000 V without Pin 6 50 Hz 1,500 V 1 min. Between Contacts
Terminal Strength	10N
Solderability	260 °C for 5 seconds
Storage Temp. Range	-55°C to 125°C
Operating Temp. Range	-55°C to 100°C
Relative Humidity	85% (at 40°C)
Weight	13.5 grams
Material Compliant To	EU RoHS V2, EU REACH V3
Insulation Resistance	1,000 MΩ min, at 500 VDC, 50% RH

ORDERING INFORMATION

Example:	PTRD	-1C	-12	S	T	-T3	-X	E	A	0.6
Model:	PTRD (PTRD-T)									
Contact Form:	1A, 1B, 1C									
Coil Voltage:	3, 5, 6, 9, 12, 15, 18, 24, 28, 48, 110									
Enclosure:	T2 & T3: C: Dust Cover; S: Sealed; T4 & T5: S: Covered, Not Washable*									
Insulation Material:	Nil: Class F									
Contact Material:	Nil: AgCdO; T: AgSnO ₂ In ₂ O ₃									
Mounting Type:	T2: 1 Form A PCB & QC; T3: 1 Form C PCB & QC; T4: 1 Form A Panel all QC; T5: 1 Form C Panel all QC									
RoHS Compliant:	-X									
IP67 Epoxy Sealed:	E: Epoxy Sealed to IP67									
Pinout:	A: Alternate Quick Connect Pinout									
Coil Sensitivity:	Nil: 0.9 W*; 0.6: 0.6 W (*0.9 W is Industry Standard)									
Gold Plated Contacts:	Nil: None; G: AgCdO+Au									

T2 & T3 Box Quantity: 600; Inner Box 300, T4 & T5 Box Quantity: 400; Inner Box: 100

COIL DATA

Coil Voltage (VDC)		Coil Power (W) Resistance (Ohms ± 10%)		Must Operate Voltage Max (VDC)	Must Release Voltage Min (VDC)
Rated	Max	0.6 W	0.9 W		
3	3.9	15	10	2.25	0.3
5	6.5	42	28	3.75	0.5
6	7.8	60	40	4.50	0.6
9	11.7	135	90	6.75	0.9
12	15.6	240	150	9.00	1.2
15	19.5	375	260	10.25	1.5
18	23.4	540	380	13.50	1.8
24	31.2	960	640	18.00	2.4
28	36.4	1,307	871	21.0	2.8
48	62.4	3,840	2,560	36.00	4.8
110	143	20,167	13,445	82.50	11.0

*0.9 W is Industry Standard

COIL DATA Continued

Operate Time	Less than 15 ms
Release Time	Less than 10 ms
Power Consumption	0.9 W, 0.6 W

NOTES:

The use of any coil voltage less than the rated voltage will compromise the operation of the relays. Must Operate Voltage and Must Release Voltages are for test purposes only and are not to be used as design criteria.

MOUNTING TYPE (mm/inches)

Knock off, on top corner, nib for ventilation after soldering and water wash.

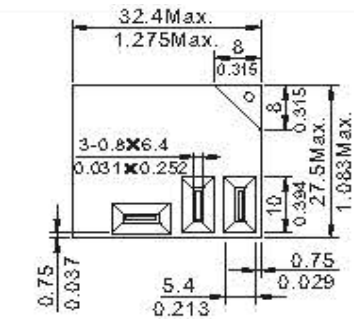

Note:
Power Pins are 0.8 mm x 1.5 mm
Coil Pins are Ø0.8 mm

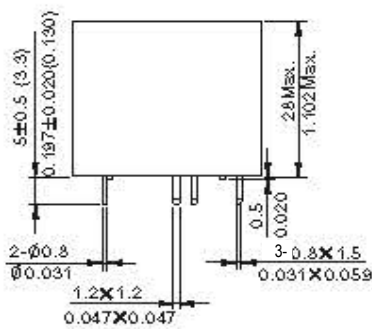

“T2” & “T3”

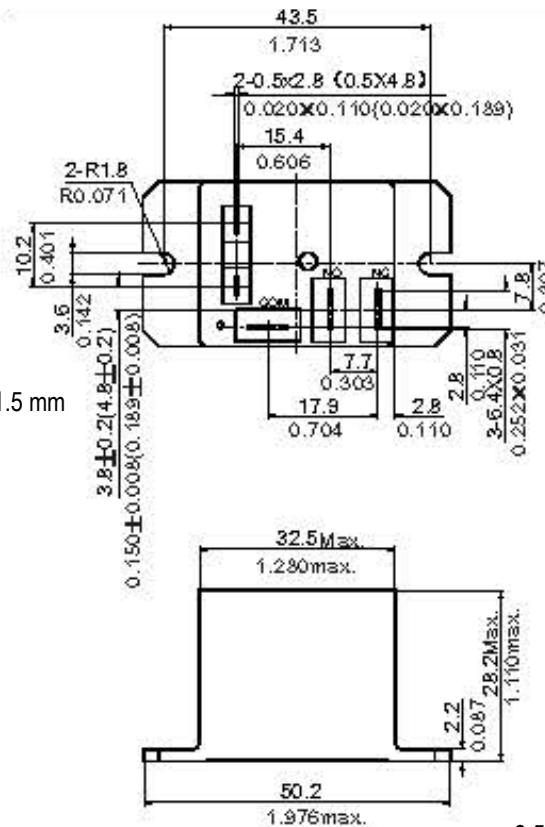

“T4” & “T5”

3.5 mm SPDT 12 Amp
3.5 mm SPDT 12 Amp

ALTERNATE MOUNTING TYPE (mm/inches)

Knock off, on top corner, nib for ventilation after soldering and water wash.

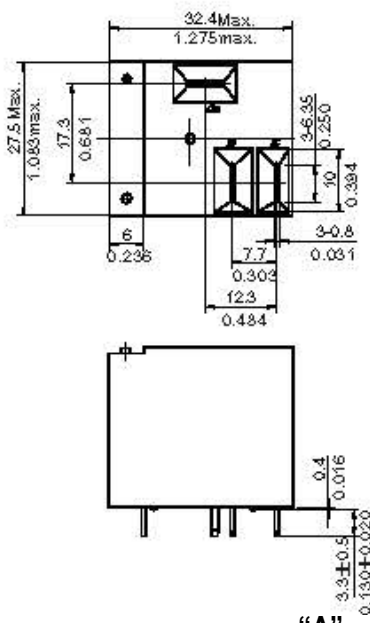

"A"
T2 & T3

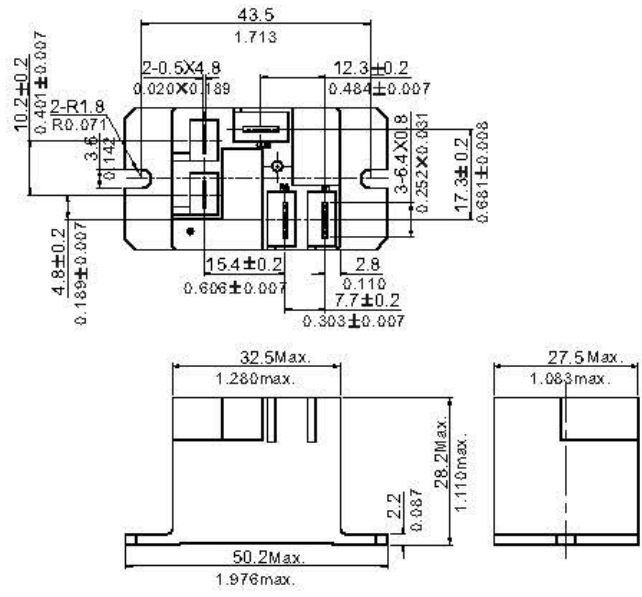

"A"
T4 & T5

PRINTED CIRCUIT BOARD LAYOUT

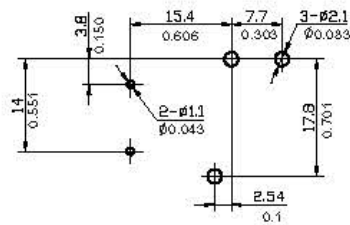

(Bottom View)

CONTACT FORMS

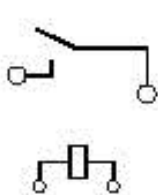

1A

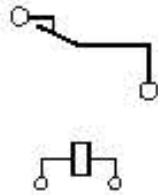

1B

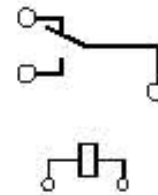

1C

(Bottom View)



T90 Style Relays

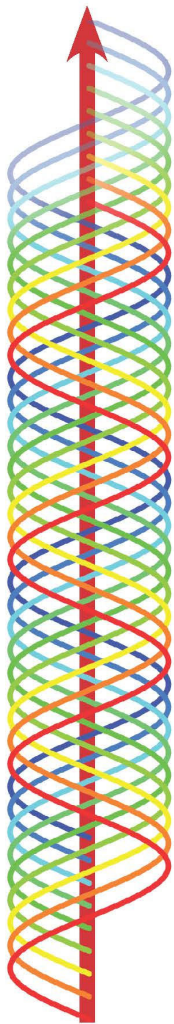
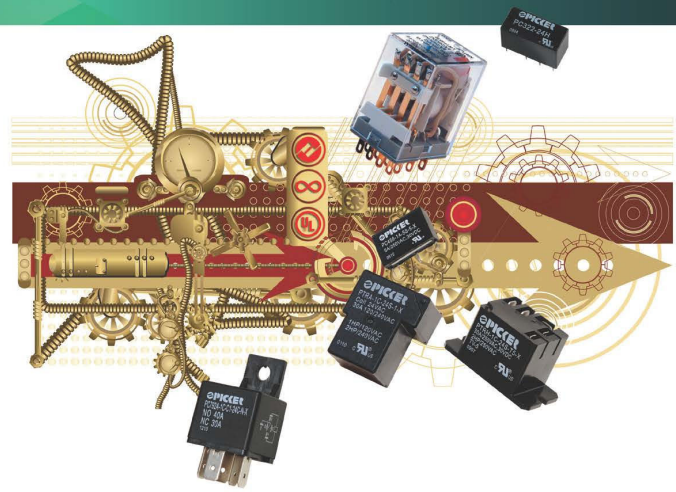

50 Amp

PTRE 50/35 Amp 1,500 W, 12,000 VA

- Larger Contacts than PTRD/PTRDE
- **Braided Copper Wire Added to Dissipate Heat from Contacts to the Coil Frame and PCB Pins**
- 50 Amp 240 VAC 10,000 Cycle UL Resistive Rating
- Class F Material -40° to 125° C Standard



40+ Amp

PTRDE 40/30 Amp 1,200 W, 10,000 VA

- **Braided Copper Wire Added to Dissipate Heat from Contacts to the Coil Frame and PCB Pins**
- 40 Amp 240 VAC 50,000 Cycle UL Resistive Rating
- Class F Material -40° to 125° C Standard

40 Amp

PTRD 40/30 Amp 1,200 W, 10,000 VA PTRA AC Coil Options from 12 to 277 VAC

- Larger Contacts than PTRH
- 40 Amp 240VAC UL Resistive Rating
- 25 Amp 277 VAC 100K Cycles UL Resistive Rating
- Class F Material -40° to 125° C Standard



30 Amp

PTRH 30/20 Amp 900 W, 7,500 VA

- 30 Amp 277 VAC UL General Purpose Rating
- 30 Amp 250 VAC 100K Cycle UL Resistive Rating
- Class B -40° to 100° C Standard, Optional Class F

Packaging Options (i.e. PTRH-T)



Dust Cover or Sealed with Scratch off Nib



-T (T2 & T3) with PC Pins and Contact QC



-T (T4 & T5) w/QC Tabs & Mounting Ears



-OT (OT2 & OT3) with PC Pins and Contact QC



-OT (OT4 & OT5) w/QC Tabs & Mounting Ears