

## General Description

The epc635 is a fully integrated 3D-TOF imager with a resolution of 160 x 60 pixels (Half-QQVGA). As a system on chip, the epc635 contains next to the CCD pixel-field the complete control logic to operate the device. The output of the chip is 12 bit DCS distance data per pixel, which are accessible through a high-speed digital 8-bit parallel video interface.

Only few additional components are needed to generate a complete 3D camera. Depending on illumination power and optical design, a resolution in the millimeter range for distances up to dozens of meters is feasible. Up to 512 full frame TOF images are delivered in rolling mode. The extremely high sensitivity of the chip allows for a reduced illumination power and reduced overall power consumption compared to other TOF imagers.

epc635 is based on the same technology and instruction set as the epc660 QQVGA TOF imager from ESPROS.

An evaluation kit for the epc635 is available with hard- and software examples and a comprehensive manual to speed up system integration.

## Applications

- People detection and counting
- Postal parcel size measurement
- Machine safety
- Helicopter near terrain flight assistance
- ADAS systems
- Pedestrian detection and breaking systems
- Man-Machine interface
- Gesture control
- Body size measurement
- General volumetric mapping
- Mobile robotics
- Simultaneous localization and mapping (SLAM)

## Block Diagram

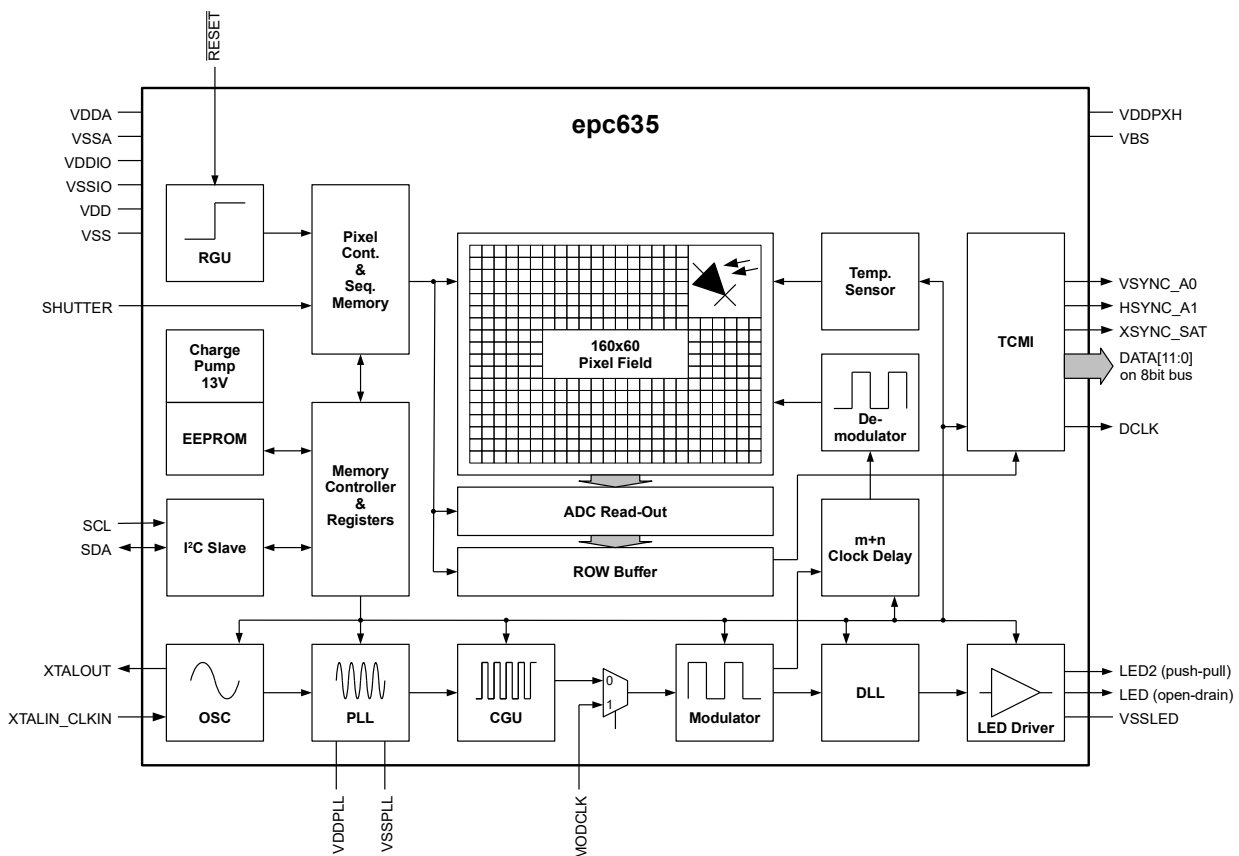

Figure 1: Functional block diagram

## Main Features

### ■ General

- 3D TOF imager in full monolithic design
- 160 x 60 pixel-field, backside illuminated
- QE >80% @ 850nm
- Full well capacity 8'000 ke- (ambient and signal)
- 128 fps full 3D TOF frame rate, in rolling mode up to 512fps
- Integrated temperature sensor

### ■ Measurement performance

- Absolute accuracy in the centimeter range with appropriate setup and calibration

### ■ Integrated LED (or laser diode) driver

- Laser diode (LD) illumination possible
- Open-drain LED output pad, up to 200mA drive
- Push-pull LED2 output pad, up to 50mA drive

### ■ Parallel digital data interface TCMI

- 80MS/s max. data rate, 2.5/3.3V compatible
- 12/8-bit DATA output + XSYNC/SAT flag on 8 bit parallel TCMI interface.
- VSYNC, HSYNC and DCLK outputs

### ■ I<sup>2</sup>C control interface (slave)

- 400kHz (FM) / 1MHz (FM+)

### ■ Integrated EEPROM 128 x 8-bit

- Calibration data and user programmable parameters
- Unique chip ID

### ■ System / Modulation clock

- System clock 4MHz, internal by using crystal/resonator or using external input
- External LED/LD modulation input MODCLK (optional) up to 80MHz

### ■ Power supply

- Supply voltages +10V, +5V, +2.5/3.3V, +1.8V, -10V
- Power consumption approx. 300mW (average)

### ■ Packaging

- 6.3x4.2mm cost optimized 44pin CSP (chip scale package),
- Backside illuminated flip-chip SMD mounting

### ■ Other data

- ROHS compatible

## Measurement Modes

### ■ Illumination modulation modes

- Sinusoidal modulation
- Selectable modulation frequencies 0.625 ... 20MHz resulting in unambiguity distance of 7.5m ... 240m

### ■ Distance measurement modes

- 128 fps 3D TOF with 4x DCS frames, full pixel-field
- 256 fps 3D TOF with 2x DCS frames, full pixel-field
- 512 fps 3D TOF with rolling read-out 4x DCS frames, full pixel-field
- SHUTTER release input for precise start/stop and single / continuous measurement control

### ■ Non distance measurement modes

- Ambient-light measurement (Grayscale imaging without illumination)
- Grayscale image with active illumination

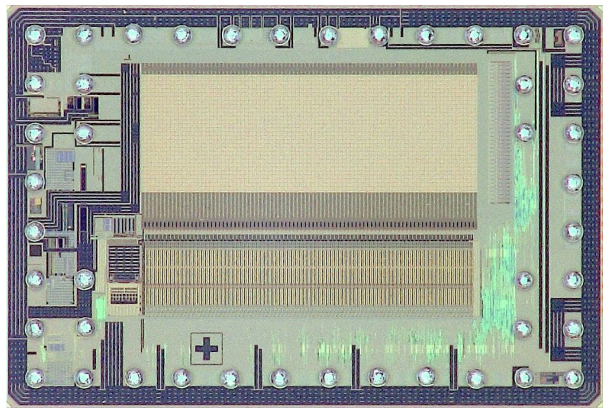

Figure 2: Picture of the epc635 die

# Table of contents

<b>1. Electrical, optical and timing characteristics</b>	<b>6</b>
1.1. Operating conditions and electrical characteristics	6
1.2. Absolute maximum ratings	7
1.3. Timing parameters	7
1.4. Optical characteristics	7
1.5. Sensitivity	8
1.6. Ambient-light suppression (ABS)	8
1.7. Other optical parameters	9
1.8. Distance measurement temperature drift	9
1.9. Temperature sensor characteristics	9
<b>2. Pin-out</b>	<b>10</b>
2.1. Pin mapping	10
2.2. Pin list	10
2.3. Power domains and ESD protection	12
<b>3. Packaging and layout information</b>	<b>12</b>
3.1. Mechanical dimensions	12
3.2. Parasitic light sensitivity (PLS)	13
3.3. Pin1 marking	14
3.4. Location of the photosensitive area	14
3.5. PCB design and SMD manufacturing process considerations	14
3.6. Tape & reel information	15
<b>4. Ordering information</b>	<b>15</b>
4.1. Notes to various chip releases	15
<b>5. Hardware implementation</b>	<b>16</b>
5.1. Typical application diagram	16
5.2. Application diagram part list	17
5.3. Hardware implementation notes	17
5.4. Clock source	18
5.5. External modulation MODCLK	19
5.6. Supply, reset and start-up options	19
5.6.1. Supply voltages and external reset	19
5.6.2. Start-up (Clock, PLL turn-on and EEPROM copy)	20
5.6.3. Strap pins	20
5.7. LED driver	20
5.8. DLL (Delay Line)	20
5.9. Application system overview	22
<b>6. TOF camera interface (TCMI)</b>	<b>22</b>
6.1. TCMI clock	22
6.1.1. Continuous clock mode	22
6.1.2. Gated clock mode	23
6.2. Single or continuous measurement control	23
6.2.1. Single measurement control	23
6.2.2. Continuous measurement control (auto-run)	23
6.3. TCMI timing	24
6.4. TCMI data format	25
6.5. TCMI embedded synchronization mode	26
6.6. Frame rate and data-out performance	27
6.7. Memory space estimation	28
<b>7. Pixel architecture</b>	<b>28</b>
<b>8. Pixel-field and operation modes</b>	<b>29</b>
8.1. Pixel coordinates	29
8.2. Operation modes	29
8.2.1. Full resolution mode (default)	29
8.2.2. Dual phase mode (motion blur reduction)	30
8.2.3. Dual integration time mode (high dynamic range, HDR mode)	30
8.3. Pixel saturation detection	31

8.3.1. Hardware saturation flag .....	31
8.3.2. Software saturation flag .....	31
8.4. ADC conversion speed-up .....	31
<b>9. Imaging .....</b>	<b>31</b>
9.1. Distance measurement (3D TOF) .....	31
9.2. Distance calculation algorithm .....	32
9.2.1. Unambiguity range versus time base setting .....	32
9.2.2. Quality of the measurement .....	33
9.3. Grayscale imaging .....	34
9.4. Calibration and compensation of TOF cameras .....	34
9.5. Noise reduction and signal filtering .....	34
<b>10. Temperature sensor .....</b>	<b>36</b>
10.1. Initialization .....	36
10.2. Read-out during runtime .....	36
10.3. Calculate temperature in °C .....	37
<b>11. Application information .....</b>	<b>38</b>
11.1. Start-up and initialization sequence .....	38
11.2. Image acquisition .....	38
11.3. 3D TOF distance measurement flow .....	38
11.4. Integration time setting .....	41
11.5. Special mode setting .....	42
11.5.1. Dual phase mode (motion blur reduction) .....	42
11.5.2. TOF and grayscale single DCS acquisition with 2 different integration times (High dynamic range) .....	42
11.6. Power consumption .....	42
11.7. Rolling DCS frames .....	44
11.8. Enhanced rolling DCS frame mode .....	44
<b>12. Parameter and configuration memory .....</b>	<b>46</b>
12.1. Sequencer program .....	46
12.2. Data memory map .....	46
12.2.1. Control page .....	46
12.2.2. RAM page .....	46
12.2.3. EEPROM page .....	46
<b>13. I<sup>2</sup>C interface .....</b>	<b>47</b>
13.1. Device addressing .....	47
13.2. I <sup>2</sup> C bus protocol notation .....	47
13.3. I <sup>2</sup> C bus timing .....	47
13.4. I <sup>2</sup> C commands .....	49
13.4.1. Software reset .....	49
13.4.2. Device address reload .....	49
13.4.3. Write single-byte .....	49
13.4.4. Write multi-byte .....	49
13.4.5. Read single-byte .....	50
13.4.6. Read multi-byte .....	50
13.4.7. Command timing .....	50
<b>14. Register map .....</b>	<b>52</b>
14.1. Control page 0x00 ~ 0x7F .....	52
14.2. RAM page (0x80 ~ 0xEF) .....	54
14.3. EEPROM page, indirect data access section (0xF0 ~ 0xFF) .....	58
<b>15. Control command examples .....</b>	<b>58</b>
15.1. Software reset .....	58
15.2. 4 DCS: Acquire DCS0 ... 3 frames with $t_{int} = 20\mu s$ @ 10MHz modulation frequency .....	58
15.3. 4 DCS: Acquire DCS0 ... 3 frames with $t_{int} = 20\mu s$ , followed by DCS 0 ... 3 with $t_{int} 400\mu s$ @ 10MHz mod. frequency .....	58
15.4. 2 DCS: Acquire DCS0 and 1 frames with $t_{int} = 20\mu s$ @ 10MHz modulation frequency .....	59
15.5. Indirect single write to EEPROM: Store 1 byte at user register 0xF0 .....	59
15.6. Indirect single read from EEPROM: Read 1 byte from user register 0xF0 .....	59
15.7. Reading part version (register 0xFB) .....	59
15.8. Reading IC version (register 0x01) .....	59
15.9. Reading WAFER ID and CHIP ID .....	60
15.10. Pixel sequencer code write procedure .....	60

15.11. Pixel sequencer code .....	60
15.12. Pixel sequencer code readback .....	62
<b>16. Addendum .....</b>	<b>64</b>
16.1. Terms, definitions and abbreviations .....	64
16.2. Related documents .....	64
<b>17. IMPORTANT NOTICE .....</b>	<b>65</b>

# 1. Electrical, optical and timing characteristics

All characteristics are at typical operational ratings,  $T_A = +25^\circ\text{C}$ , modulation frequency 10MHz, unless otherwise stated

## 1.1. Operating conditions and electrical characteristics

Parameter	Description	Conditions/Comments	Min.	Typ.	Max.	Units
$V_{DD}, V_{DDPLL}$	Digital supply voltage	Ripple <sup>1</sup> < $\pm 20$ mV	1.71	1.80	1.98	V
$V_{DDIO}$	IO supply voltage <sup>3</sup>	Ripple <sup>1</sup> < $\pm 50$ mV	2.25	2.5/3.3	3.63	V
$V_{DDA}$	Analog 1 supply voltage <sup>2</sup>	Ripple <sup>1</sup> < $\pm 20$ mV	4.9	5.0	5.1	V
$V_{DDPXH}$	Analog 2 supply voltage <sup>2</sup>	Ripple <sup>1</sup> < $\pm 20$ mV	9.5	10	10.5	V
$V_{BS}$	Bias supply voltage	Ripple <sup>1</sup> < $\pm 50$ mV	-10.5	-10.0	-9.75	V
$I_{VDD}$	Digital supply current	@nominal voltage		10	11	mA
$I_{VDDPLL}$	PLL supply current	@nominal voltage		4		mA
$I_{VDDIO}$	IO supply current <sup>4</sup>			15	25	mA
$I_{VDDA}$	Analog supply current	@nominal voltage		22	33	mA
$I_{VDDPXH}$	Analog 2 supply current	@nominal voltage		2	2	mA
$I_{VBS}$	Bias supply current <sup>8</sup>			-2.0 <sup>8</sup>		mA
$V_{LED\_ON}$	LED on-voltage forward voltage	@ $I_{LEDOD-ON} = 100$ mA @ $I_{LEDOD-ON} = 200$ mA		0.1 0.2		V V
$I_{LED\_LEAK}$	LED leakage current	@ LEDOD off-voltage			10	$\mu\text{A}$
$I_{LED2\_SINK}$	LED2 output sink/source current				50	mA
$V_{IH\_VDDIO}$	Digital high level input voltage <sup>5</sup>	excluding XTALIN	$0.7 \times V_{DDIO}$			V
$V_{IL\_VDDIO}$	Digital low level input voltage <sup>5</sup>	excluding XTALIN			$0.3 \times V_{DDIO}$	V
$V_{IH\_XTALIN}$	Digital high level input voltage	XTALIN	1.35			V
$V_{IL\_XTALIN}$	Digital low level input voltage	XTALIN			0.2	V
$V_{OH}$	Digital high level output voltage <sup>5,6</sup>		$0.8 \times V_{DDIO}$			V
$V_{OL}$	Digital low level output voltage <sup>5,6</sup>				$0.2 \times V_{DDIO}$	V
$R_{PD}$	Pull-down resistor in RESET, VSYNC_A0, HSYNC_A1			600		k $\Omega$
$I_{IH}$	Digital high level input current <sup>7</sup>	$V_{IH}$ max.			$10^{-7}$	$\mu\text{A}$
$I_{IL}$	Digital low level input current <sup>7</sup>	$V_{IL}$ min.	$-10^{-7}$			$\mu\text{A}$
$I_{OH}$	Digital output source current <sup>7</sup>	$V_{OH}$ max.			50	mA
$I_{OL}$	Digital output sink current <sup>3</sup>	$V_{OL}$ min.	-50			mA
$C_{IO}$	IO load capacitance <sup>5</sup>				30	pF
$f_{IO}$	IO switching frequency <sup>5</sup>			20	80	MHz
$P_{PK}$	Power dissipation (average)	See 32		300		mW
$R_{Th}$	Thermal resistance	on PCB with underfill			40	$^\circ\text{K/W}$
$T_{OP}$	Operating temperature		-40		105	$^\circ\text{C}$

Table 1: Operating conditions and electrical characteristics

### Notes:

- <sup>1</sup> Min. and Max. voltage values include noise and ripple voltages.
- <sup>2</sup> Analog voltage supplies have direct influence on measurement performance. They must be properly decoupled for low noise and ripple.
- <sup>3</sup> IO voltage supply must be equal to external processor's IO supply voltage levels used in the application. It can be set to any value within min and max. operating voltage.
- <sup>4</sup> When device is operated at max  $f_{DCS}$  frame rate, DCLK at 40MHz, driving loads 15pF each.
- <sup>5</sup> I<sup>2</sup>C pins SCL and SDA are open-drain outputs and need termination (Pull-up resistor) according to I<sup>2</sup>C standards.
- <sup>6</sup>  $V_{OH/OL}$  and  $I_{OH/OL}$  values are measured at max  $C_{IO}$  and max  $f_{IO}$ .
- <sup>7</sup> Value is without termination resistors
- <sup>8</sup> A bright illuminated white target right in front of the chip with lens leads to an  $I_{VBS}$  of approx. -2.0 mA, without any illumination approx. -2.0 mA and with strong illumination (approx. 55 mW/cm<sup>2</sup>, no lens) typ. -9.0 mA.

## 1.2. Absolute maximum ratings

Parameter	Conditions
Supply voltage $V_{DD}$ , $V_{DDPLL}$	-0.5V ... +2.0V
Supply voltage $V_{DDIO}$ , $V_{DDA}$ , $V_{DDPXM}$	-0.5V ... +5.5V
Supply voltage $V_{DDPXH}$	-0.5V ... +13.5V
Supply voltage $V_{BS}$	-12.0 ... +0.5V
Voltage to any pin in the same $V_{SC}$ supply class.	$V_{SC\ min} - 0.3V \dots V_{SC\ max} + 0.3V$
LED sink current $I_{ON\_LED}$ (modulated peak current, refer to 17)	200 mA @ $T_J$ 85°C 25 mA @ $T_J$ 125°C linear reduction between 85 and 125°C
LED off-voltage $V_{OFF\_LED}$ (open-drain output)	7.5 V
ESD rating	JEDEC HBM class 1C (1kV to < 2kV)
Junction temperature ( $T_J$ )	-40°C to +125°C
Relative humidity	0 ... 95%, non-condensing

Table 2: Absolute maximum ratings

## 1.3. Timing parameters

Parameter	Description	Conditions	Min.	Typ.	Max.	Units
$t_{STARTUP}$	Start-up time	after applying external supplies		340	1'000	µs
$t_{RESET}$	RESET		100			ns
$t_{PLL}$	PLL lock time				30	µs
$t_{DLL}$	DLL delay for 1 step	approx. 30cm distance shift per step. Refer for details to register 0x73 and 21, for exact value to register 0xE9.		2.1		ns
$t_{DRV}$	Illumination driver delay	delay of LED/LED2 versus demodulation, refer to 21		8.4		ns
$t_{EEPROM\_to\_CFG}$	Load CFG registers	copy EEPROM to CFG registers		340		µs
$t_{EEPROM\_Write}$	Write EEPROM	waiting time per byte			25	ms
$f_{XTAL}$	Clock frequency	determines the distance measurement accuracy	3.8	4	4.2	MHz
$df_{XTAL}$	Clock frequency deviation	any deviation is added as a linear distance error			±100	ppm
$f_{JITTER}$	Clock frequency phase jitter	peak-to-peak, cycle to cycle			50	ps
$f_{LED}$	LED modulation frequency, refer to chapter 11.1.2., section 13	Internal modulation	0.625		10	MHz
		External modulation	0.625		20	MHz
$f_{MODCLK}$	Ext. modulation clock	refer to chapter 5.5.			80	MHz
$t_{LED\_rise/fall}$	Rise/fall time LED/LD	slower rise/fall time lead to illumination losses			12	ns
$f_{DCLK}$	TCMI DCLK	8 bit TCMI data + saturation flag		20	80	MHz
$f_{TCMI\_data}$	TCMI data rate			130	520	Mbit/s
$f_{SCL}$	I <sup>2</sup> C data rate				1	Mbit/s

Table 3: Timing parameters

## 1.4. Optical characteristics

Parameter	Description	Conditions/Comments	Min.	Typ.	Max.	Units
$A_{PIXEL}$	Pixel photosensitive area	100% fill factor		20 x 20		µm
$A_{SENSOR}$	Pixel field area	160 x 60 pixel		3.2 x 1.2		mm

Table 4: Optical characteristics

### Note:

Values depend on camera integration. Typical examples only. Refer for details to 21 and application note AN10 Calibration and Compensation, chapter temperature compensation.

### 1.5. Sensitivity

@ integration time 100  $\mu$ s

Parameter	Description	Min.	Typ.	Max.	Units	
TOF sensitivity $S_{TOF}$	<ul style="list-style-type: none"> <li>Modulation frequency 12MHz</li> <li>Amplitude 1,400 LSB</li> </ul>	640nm	0.75	0.9	1.05	$\frac{nW/mm^2}{LSB}$
		850nm	0.50	0.6	0.70	
		940nm	0.65	0.8	0.95	
TOF <sub>SENS</sub> FPN	Sensitivity fix pattern noise, @ 1,400 LSB		40	100	LSB	
TOF <sub>DIST</sub> FPN	Distance fix pattern noise, @ 1,400 LSB		18	50	mm	
$I_{Dark}$	Dark current (drift during readout)		10	20	LSB/ms	
Grayscale sensitivity	Normal operation	0.19	0.25	0.31	$\frac{nW/mm^2}{LSB}$	
	Temperature sensing mode	0.48	0.62	0.76		
$H_v$	Optical sensitivity		150k		$\frac{LSB}{Lux/sec}$	
GS <sub>STD</sub>	Grayscale standard deviation		25	100	LSB	

Table 5: Sensitivity

### 1.6. Ambient-light suppression (ABS)

An important function of the 3D TOF pixel is the ambient-light suppression. It removes DC or low frequency modulated light caused by sunlight, room illumination, etc. from the modulated light generated by the camera illumination. The amount of collected ambient light is proportional to the integration time. The longer the integration time, the more unwanted light will be collected. It's a good practice to keep the integration time for TOF imaging below 1ms. In addition, optical bandpass filters to block the unwanted light spectrum is mandatory.

Parameter	Ambient light suppression	Integration time	Wavelength	Min.	Typ.	Max.	Units
$E_e$	Irradiance, DC light	100 $\mu$ s	640nm	0.30			$mW/mm^2$
			850nm	0.20			
			940nm	0.25			

Parameter	Ambient light suppression	Integration time	Center wavelength	Bandwidth	Min.	Typ.	Max.	Units
$E_v$	Luminance equivalent, sunlight	500 $\mu$ s	640nm	$\pm 27.5nm$	85			kLux
			850nm	$\pm 32.5nm$	70			
			940nm	$\pm 30nm$	190			

Table 6: Ambient light suppression

Note:

The default and suggested chip configuration is set to achieve highest possible frame rate and using additional ambient-light correction according the Application note AN10 Calibration and compensation: Register 0x90, bit 3 = 0 and 0xAB = 0x00. A 20% more efficient ambient-light suppression is possible, if the the following registers are modified:

0x90, bit 3 = 1

0xAB = 0x01

It turns the LED modulation before each integration for additional 33 $\mu$ s @ 24MHz modulation frequency on. This modulation is independent of the effective integration time. The on-time depends on the modulation frequency by  $t_{ON} = 40\mu s * 20MHz / \text{modulation frequency}$ .



### 1.7. Other optical parameters

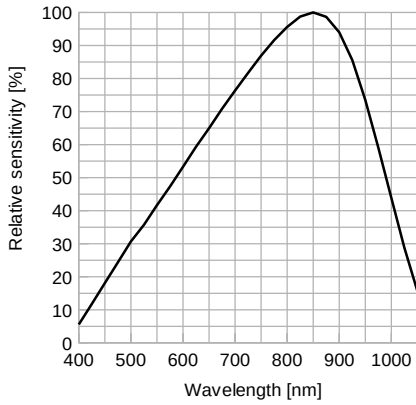

Figure 3: Relative spectral sensitivity ( $S_r$ ) vs. wavelength

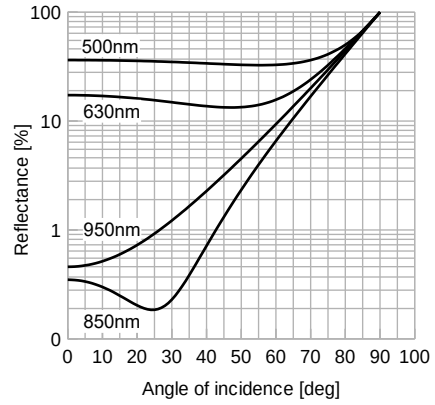

Figure 4: Reflectance vs. illumination angle (AOI)

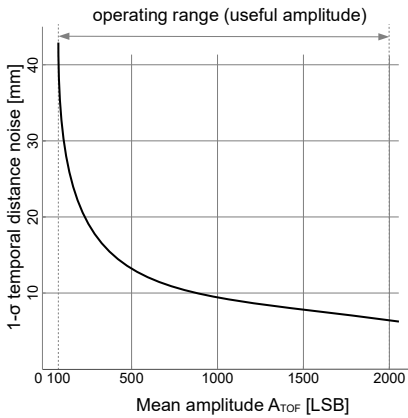

Figure 5: Typ. distance noise, single shot, 4 DCS, no ambient-light, see chapter 9.2.2.

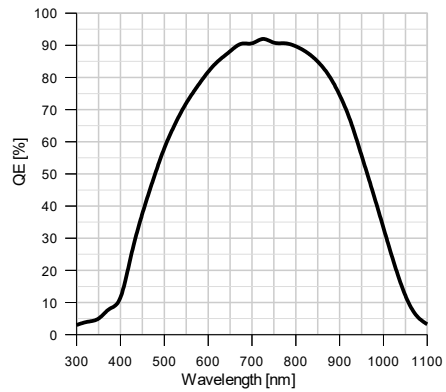

Figure 6: Typical quantum efficiency

### 1.8. Distance measurement temperature drift

@12MHz modulation frequency

Parameter	Description	Min.	Typ.	Max.	Units
$TC_{PIX}$	Pixel		12.9		mm/K
$TC_{OD}$	LED/LD driver		2.7		mm/K
$TC_{DLLn}$	DLL stage, per stage		0.65		mm/K

Table 7: Optical characteristics

Note: Values vary from imager to imager. Refer for details to 21 and application note AN10 Calibration and Compensation, chapter temperature compensation.

### 1.9. Temperature sensor characteristics

Parameter	Description	Conditions	Min.	Typ.	Max.	Units
$T_{TEMP}$	Measurement range		-40		+105	°C
$P_{TEMP}$	Sensor resolution			14		bit
k	Temperature sensor gain			0.067		K/LSB
Lin	Linearity	Over temperature range		5		%
$T_{CAL}$	Calibration temperature		26.5	27.0	27.5	°C

Table 8: Temperature sensor characteristics

Note: Refer also to chapter 10.

## 2. Pin-out

### 2.1. Pin mapping

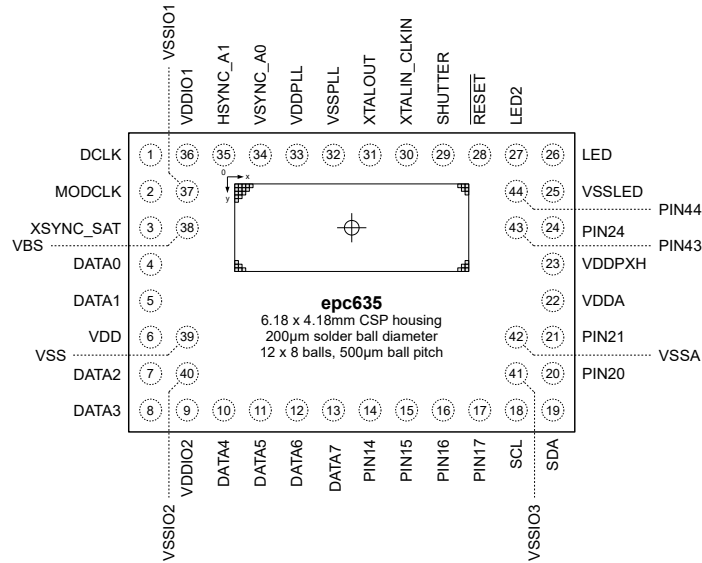

Figure 7: Pin mapping (top-view, solder balls are at the bottom, pixel-field is at the top)

### 2.2. Pin list

Pin No.	Pin name	Supply class $V_{sc}$	Pin type	RESET function	RESET level	Description
<b>IO pins</b>						
4	DATA0	$V_{DDIO}$	DIO	IPD	$V_{OL}$	TCMI high-speed output bit 0 (LSB), no pull-up resistor allowed
5	DATA1	$V_{DDIO}$	DIO	IPD	$V_{OL}$	TCMI high-speed output bit 1
7	DATA2	$V_{DDIO}$	DIO	IPD	$V_{OL}$	TCMI high-speed output bit 2
8	DATA3	$V_{DDIO}$	DIO	IPD	$V_{OL}$	TCMI high-speed output bit 3
10	DATA4	$V_{DDIO}$	DIO	IPD	$V_{OL}$	TCMI high-speed output bit 4
11	DATA5	$V_{DDIO}$	DIO	IPD	$V_{OL}$	TCMI high-speed output bit 5
12	DATA6	$V_{DDIO}$	DIO	IPD	$V_{OL}$	TCMI high-speed output bit 6
13	DATA7	$V_{DDIO}$	DIO	IPD	$V_{OL}$	TCMI high-speed output bit 7
1	DCLK	$V_{DDIO}$	DIO	IPD	$V_{OL}$	TCMI data clock output
34	VSYNC_A0	$V_{DDIO}$	DIO	IPD	$V_{OH}$	TCMI VSYNC output / strap input 0, refer to 5.6.3.
35	HSYNC_A1	$V_{DDIO}$	DIO	IPD	$V_{OH}$	TCMI HSYNC output / strap input 1, refer to 5.6.3.
3	XSYNC_SAT	$V_{DDIO}$	DIO	IPD	$V_{OL}$	TCMI XSYNC / TCMI Saturation flag output, no pull-up resistor allowed
18	SCL	$V_{DDIO}$	DIOD	I	$V_{IH}$	I <sup>2</sup> C clock input <sup>4</sup>
19	SDA	$V_{DDIO}$	DIOD	I	$V_{IH}$	I <sup>2</sup> C data input/output <sup>4</sup>
29	SHUTTER	$V_{DDIO}$	DI	PD	$V_{IL}$	Shutter input <sup>5</sup>
28	RESET	$V_{DDIO}$	DI	PD	$V_{IL}$	Reset input (active low), 600k $\Omega$ int. pull-down <sup>3</sup>
2	MODCLK	$V_{DDIO}$	DI	PD		Modulator/demodulator external clock input.
27	LED2	$V_{DDIO}$	DO		$V_{IL}$	LED driver push-pull output <sup>2</sup>
14	PIN14	$V_{DDIO}$	DO		$V_{OL}$	Do not any electrical connection except to a test pad (suggested).
15	PIN15	$V_{DDIO}$	DI	PU	$V_{IH}$	
16	PIN16	$V_{DDIO}$	DI	PD	$V_{IL}$	
17	PIN17	$V_{DDIO}$	DI	PU	$V_{IH}$	
<b>Digital pins</b>						
30	XTALIN_CLKIN	$V_{DDPLL}$	AI			XTAL or Resonator in / CLKIN from external clock source
31	XTALOUT	$V_{DDPLL}$	AO			XTAL or Resonator out
<b>Analog pins</b>						
26	LED	$V_{DDLED}$	AOD		$V_{LED}$	LED/LD driver open-drain output <sup>2</sup>
24	PIN24	$V_{DDLED}$	AI			Connect to VSSA with 10 k $\Omega$ m
20	PIN20	$V_{DDA}$	---			
21	PIN21	$V_{DDA}$	---			
43	PIN43	$V_{DDPXH}$	AI			Do not any electrical connection except to a test pad (suggested).
44	PIN44	$V_{DDPXH}$	AI			

Pin No.	Pin name	Supply class $V_{sc}$	Pin type	RESET function	RESET level	Description
<b>Supply pins, digital</b>						
36	VDDIO1	$V_{DDIO}$	PWR			IO supply VDDIO
9	VDDIO2	$V_{DDIO}$	PWR			
6	VDD	$V_{DD}$	PWR			Digital supply VDD
33	VDDPLL	$V_{DDPLL}$	PWR			PLL supply
37	VSSIO1	$V_{DDIO}$	GND			IO ground VSSIO
40	VSSIO2	$V_{DDIO}$	GND			
41	VSSIO3	$V_{DDIO}$	GND			
39	VSS	$V_{DD}$	GND			Digital ground VSS
32	VSSPLL	$V_{DDPLL}$	GND			PLL ground
<b>Supply pins, analog</b>						
22	VDDA	$V_{DDA}$	PWR			Analog supply VDDA
38	VBS	$V_{BS}$	PWR			Bias supply
23	VDDPXH	$V_{DDPXH}$	PWR			Analog 2 supply VDDPXH
42	VSSA	$V_{DDA}$	GND			Analog ground VSSA
25	VSSLED	$V_{DDLED}$	GND			LED/LD driver ground (return current) <sup>1</sup>

Table 9: Pin list

**Notes:**

- <sup>1</sup> VSSLED is the dedicated, isolated GND pin for the LED/LD return-current from external circuitry. It must be connected to PCB GND plane together with the other VSSA GND pins.
- <sup>2</sup> LED output can be used to drive an external amplifier with an addition of a pull-up resistor. The voltages at LED output must not exceed values in Table 1: Operating conditions and electrical characteristics.  
  
LED2 output is a push-pull driver for delivering symmetric rise/fall times to the external LED driver circuit. LED2 is internally connected to VDDIO/VSSIO supplies. During integration time, all TCMI pins are silent except for DCLK. As a result, LED2 pin will not pick up switching noise from all other TCMI pins. This can be avoided by using gated DCLK mode.  
  
LED and LED2 must not be used simultaneously for driving LED circuits on the PCB. They exhibit different insertion delays and may cause unpredicted distance offset/measurement results.
- <sup>3</sup> RESET pin has a 600k $\Omega$  (typical) internal pull-down resistor. Therefore, this pin can be safely connected to a standard GPIO of a CPU which is initially high-Z or open-drain during power-up sequence. Once the SW takes control, it can program this GPIO as output and drive 1 to release the RESET. The internal pull-down can be override by and external 10k $\Omega$  pull-up and a series capacitor to build a simple delayed power-on reset for evaluation/qualification purposes.
- <sup>4</sup> I<sup>2</sup>C pins SCL, SDA are according to I<sup>2</sup>C standards. They are I<sup>2</sup>C slave pins which need external pull-up resistors on the PCB. Values of R1 and R2 in the schematics are given only for indicative purposes and must be re-calculated according to the total capacitive load of all I<sup>2</sup>C slave/master devices and operating mode (FM or FM+) of the I<sup>2</sup>C (chapter 13.) in the application.
- <sup>5</sup> If HW shutter is not used, connect this pin to GND

'Pin type' in 9 defines the following:

- DI: Digital Input
- DO: Digital Output
- DIO: Digital Input/Output (bidirectional)
- DIOD: Digital Input/Output (bidirectional), open-Drain
- AI: Analog Input
- AO: Analog Output
- AOD: Analog Output, open-Drain
- PWR: Supply
- GND: Ground

'RESET function' in 9 defines the function of IO pins during reset:

- I: Input
- PU: internal Pull-Up
- PD: internal Pull-Down
- IPD: Input with internal Pull-Down

'RESET level' in 9 defines the level of the IO pins during/after reset (chapter 5.6.)

### 2.3. Power domains and ESD protection

The epc635 chip has internally 7 different power domains and 5 ground references which are interconnected with ESD protection diodes. All pins are also equipped with ESD protection diodes. The diodes have a breakthrough voltage of 0.3V. The designer has to take care that none of these diodes become conductive either at power-up, power-down or normal operation.

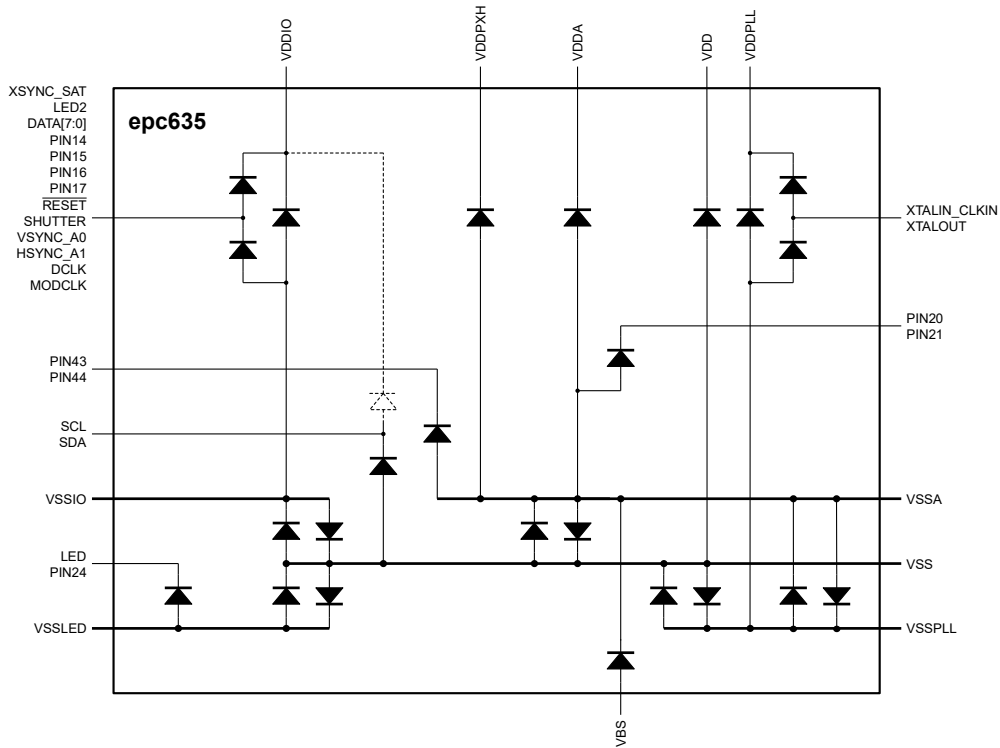

Figure 8: I/O pins and ESD protection diagram

## 3. Packaging and layout information

### 3.1. Mechanical dimensions

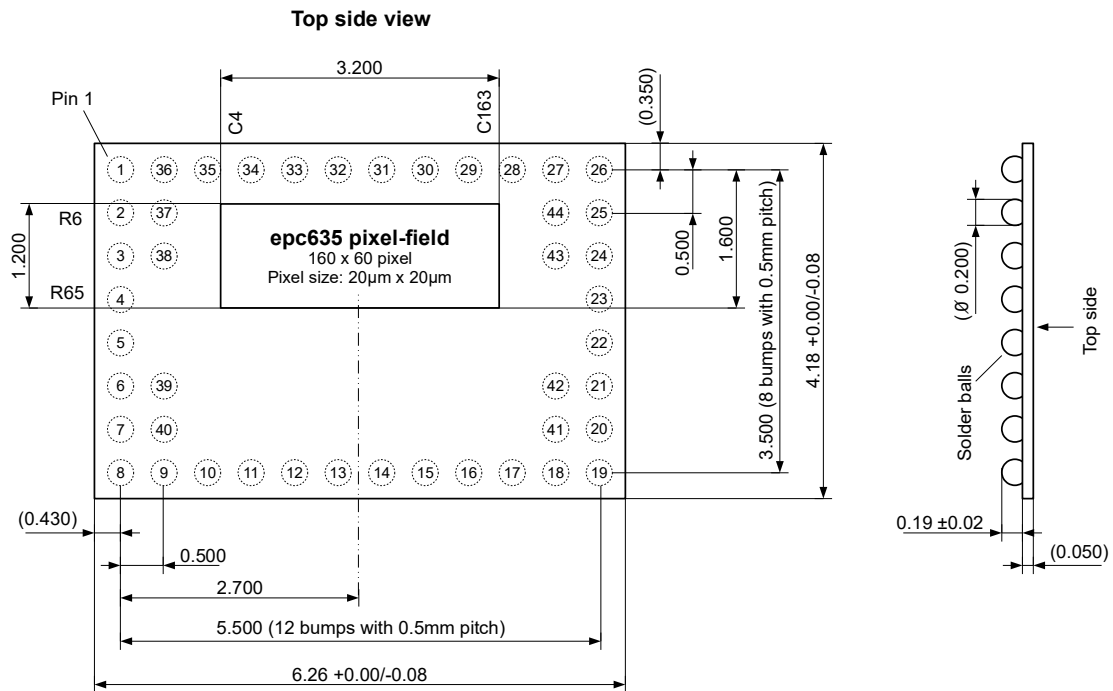



Figure 9: Mechanical dimensions

Notes:

- 
- all measures in mm
- not specified tolerances:  $\pm 0.001\text{mm}$
- Top side is illumination side

### 3.2. Parasitic light sensitivity (PLS)

CMOS circuits are sensitive to light. That is why they can be used for photo-sensing, imaging, etc. However, if strong light is radiating the chip beside the pixel field, analog and digital circuits can be affected in its function by such parasitic light. It is called parasitic light sensitivity (PLS). A known effect is a shift of the measured distance under strong ambient light.

Imager lenses have always a larger field of view than the pixel-field area. In order to prevent the chip being illuminated by strong ambient light, an opaque aperture should be placed onto the photosensitive side of the imager as shown in 10. The cover shall have a opening of  $3.490 \times 1.490 \text{ mm}$ . With regard to the  $3.200 \times 1.200 \text{ mm}$  pixel-field size, this shield can be assembled with a tolerance of  $\pm 120 \mu\text{m}$  in x and y axis. Such a cover can be made by a thin sheet metal stencil like an SMD solder paste printing stencil or by silk screen printing of black color.

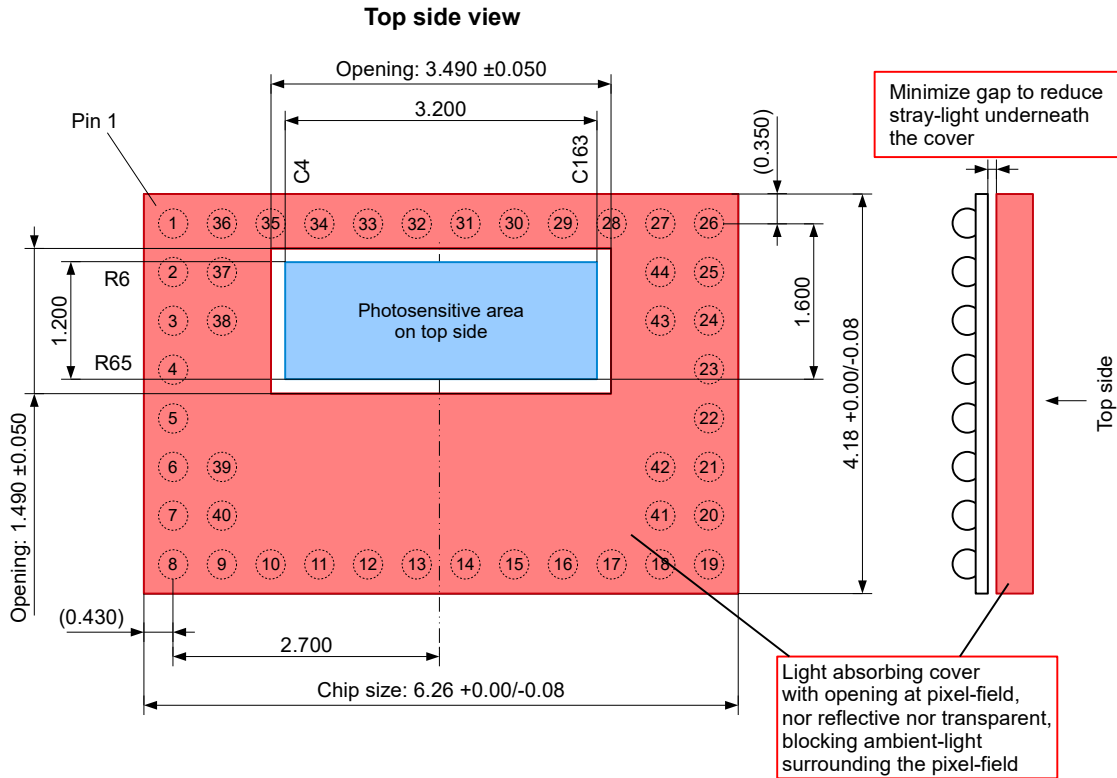

Figure 10: Opaque cover for protection against unwanted ambient-light

### 3.3. Pin1 marking

The following pictures shows the epc635 chip from the bottom side with view to the solder balls. Please note the location of pin 1. It's highly recommended to check the pin 1 location with a vision system during the SMT assembly process.

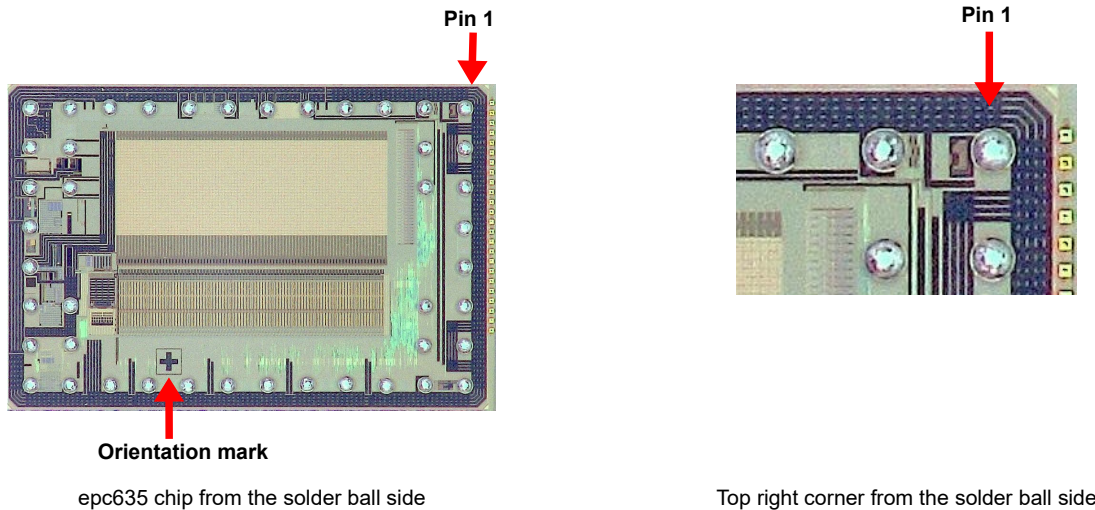

Figure 11: Pin 1 marking

### 3.4. Location of the photosensitive area

The photosensitive area is not marked (neither on the front nor on the backside of the IC). As a visible reference, a metal ring of the IC can be used. From the solder ball side it is visible. Also from the front side (photosensitive area) it can be seen with a camera which is sensitive in the near infrared wavelength domain (950 .. 1150nm).

### 3.5. PCB design and SMD manufacturing process considerations

As the epc635 chip comes in a 44 pin chip scale package with only 50µm thickness, the PCB layout should be made with special care. In addition, careful handling during the assembly process shall be assured in order to avoid mechanical damage during the assembly process. Because the silicon chip is small and light weight compared the solder balls, it is highly recommended that all tracks to the chip should come straight from the side. A symmetrical design is highly recommended to achieve high production yield. The pads and the tracks should also have exactly the same width at least for 1mm from the pad. They shall be covered by a solder resist mask in order to avoid drain of the solder tin alloy to the track.

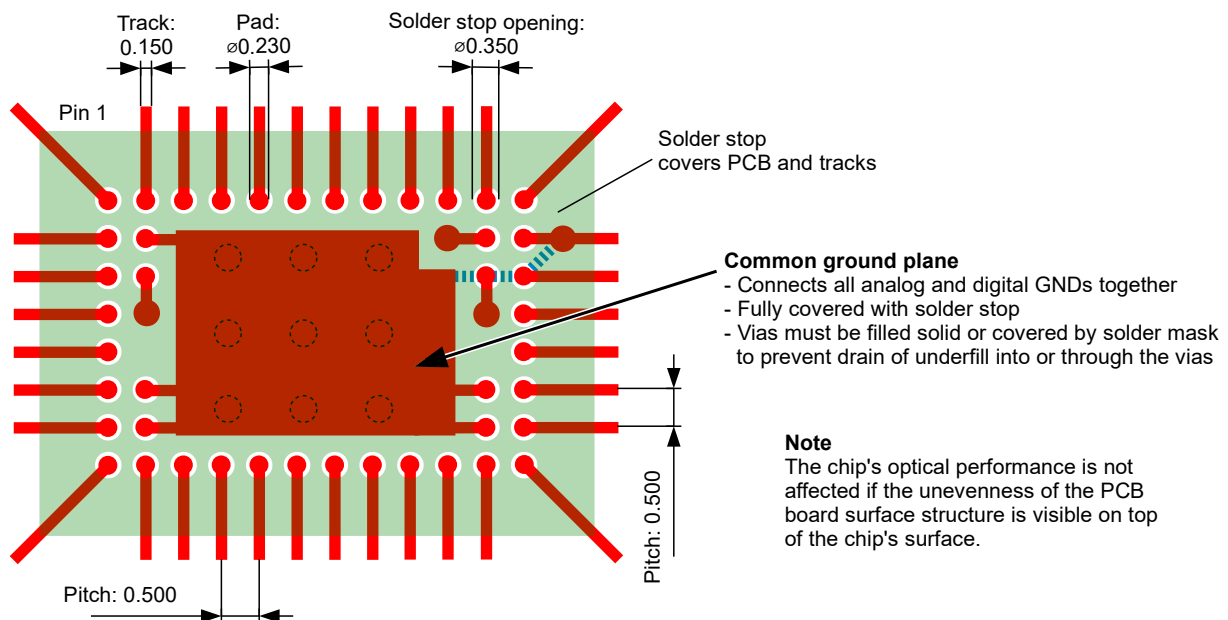

Figure 12: Recommended PCB layout (all measures in mm)

As shown in 12, a ground plane shall be placed on the top PCB layer underneath the chip. This ground plane acts as a shield to suppress high frequency emission of fast interface signal lines. It is important that this plane is completely flat. Thus, the plane must not be scattered nor divided into sections. It should be rather full-faced and no via should be placed in this plane. Otherwise chip bending might occur. In addition, the ground plane helps to dissipate the heat generated by the chip operation. A good heat dissipation is achieved if there is a temperature increase of the chip under normal operation of max. 20K. The temperature can be read direct from the chip.

Underfill of the components reduces stress to the solder pads caused by e.g. temperature cycling or mechanical bending. Furthermore the

thermal and mechanical fatigue will be reduced and the longterm reliability will be increased. Underfill material and underfill selection is application specific. It shall follow JEDEC-STD JEP150: Stress-Test-Driven Qualification of and Failure Mechanisms Associated with Assembled Solid State Surface- Mount Components. Please also, refer to the application note AN08 Process-Rules CSP Assembly which can be downloaded from the ESPROS Website at [www.espros.com](http://www.espros.com), section Downloads. Obeying these recommendations a high manufacturing yield can be achieved.

### 3.6. Tape & reel information

The devices are mounted on embossed tape for automatic placement systems. The tape is wound on 178 mm (7 inch) or 330 mm (13 inch) reels and individually packaged for shipment. General tape-and-reel specification data are available in a separate data sheet and indicate the tape sizes for various package types. Further tape-and-reel specifications can be found in the Electronic Industries Association (EIA) standard 481-1, 481-2, 481-3.

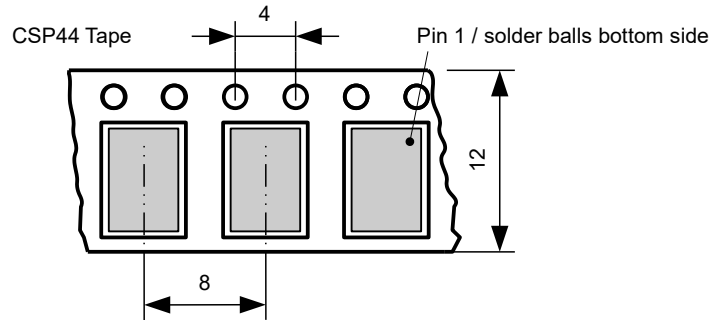

Figure 13: Tape dimensions (all measures in mm)

ESPROS does not guarantee that there are no empty cavities. Thus, the pick-and-place machine should check the presence of a chip during picking.

## 4. Ordering information

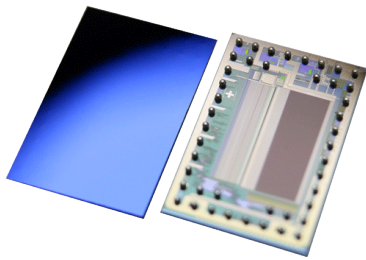

Figure 14: epc635-CSP44, top and bottom side



Figure 15: epc635 Card Edge Connector Carrier, refer to separate datasheet

Part Number	Part Name	Package	RoHS compliance
P100 181	epc635-CSP44	CSP44	Yes
P100 404	epc635 Card Edge Connector Carrier	PCB 37.25 x 36.00 mm	Yes

Table 10: Ordering Information

### 4.1. Notes to various chip releases

The supplied chip version can be identified by

- reading the extension -XXX of the part name on the packaging labels or delivery papers: epc635-CSP44-XXX.
- reading the part version register 0xFB: Refer to chapter 15.10.
- The latest download code for each chip version is included in the download package for the epc660 Evaluation Kit (see chapter 15.10).

# 5. Hardware implementation

## 5.1. Typical application diagram

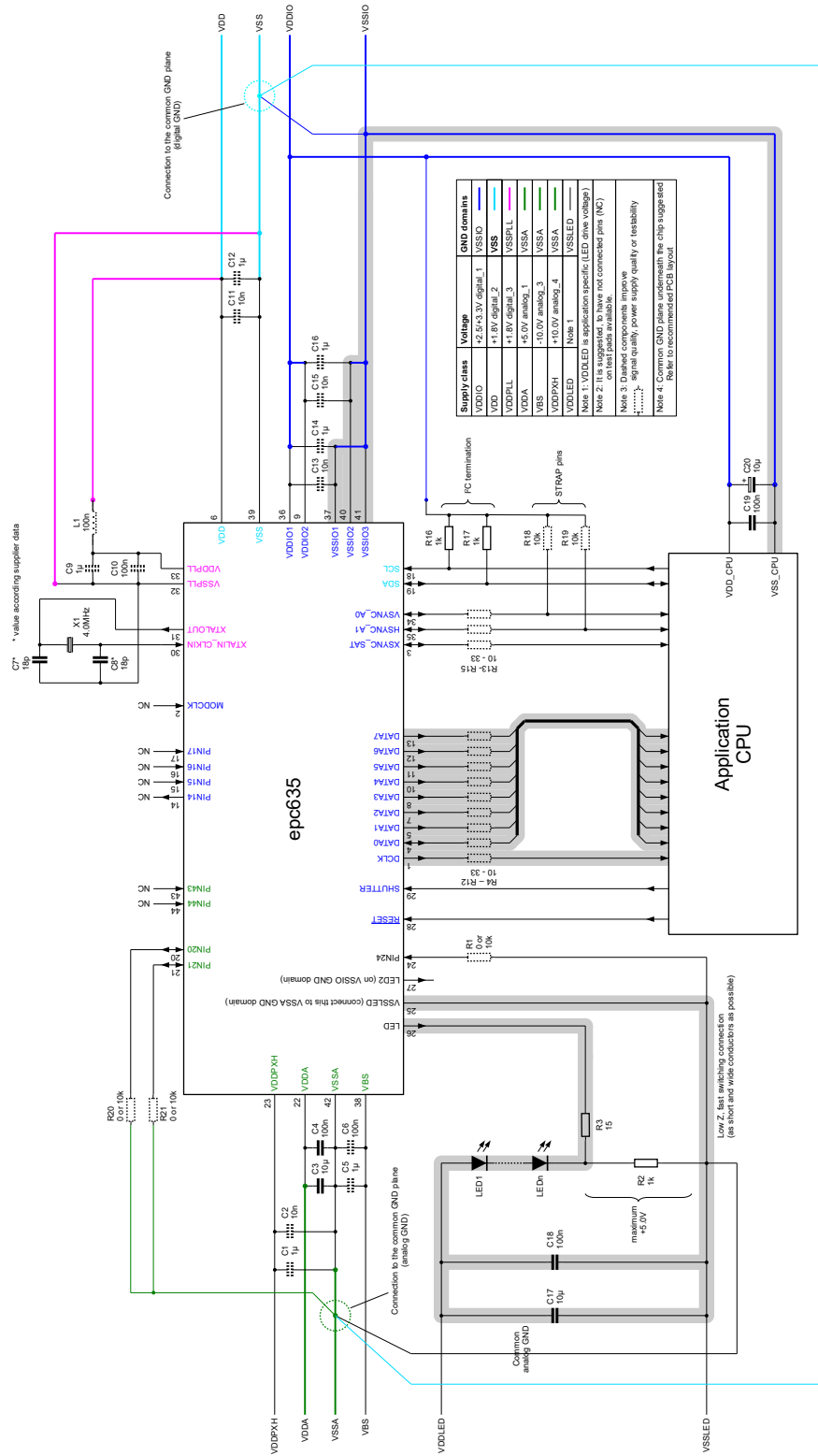

Figure 16: Typical application diagram

**Notes:**

- R4 -R15: Resistor value depends on fast bus decoupling.
- R1, R20, R21: Pins need to be connected to corresponding GND. In case of need to testability: use 10k resistors.
- R18, R19: Resistor value depends of needed strap function.
- SHUTTER and XSYNC\_SAT: Must be at low level until RESET release. Otherwise malfunction occurs.
- VSS: Connect all VSS as direct as possible using vias to the GND plane underneath the imager



## 5.2. Application diagram part list

Part designator	Description	Pin No.	Value			Tolerance	Supply class V <sub>SC</sub>	Comments
			Min.	Typ.	Max.			
Minimum part count:								
C3	VDDA	22 - 42	4.7 µF	10 µF		±20%	V <sub>DDA</sub>	Ceramic X7R
C4	VDDA	22 - 42		100 nF		±20%	V <sub>DDA</sub>	Ceramic X7R
C7, C8	XTAL	30 – 32, 31 - 32	---	18 pF <sup>2</sup>	---	±20%	V <sub>DDPLL</sub>	Ceramic NPO
X1	XTAL	30 - 31	---	4 MHz	---	±100ppm	V <sub>DDPLL</sub>	Quartz / Resonator
R4 - R15	Bus termination		0 Ohm	10 Ohm	33 Ohm	±20%	V <sub>DDIO</sub>	Resistors
R16, R17	I <sup>2</sup> C pull-up			1 kOhm		±20%	V <sub>DDIO</sub>	Resistors
R18, R19	I <sup>2</sup> C address			10 kOhm		±20%	V <sub>DDIO</sub>	Resistors
Dashed components improve signal quality, power supply quality or testability								
C1	VDDPXH	23 - 42	1 µF			±20%	V <sub>DDPXH</sub>	Ceramic X7R
C5	VBS	38 - 42	1 µF			±20%	V <sub>BS</sub>	Ceramic X7R
C9	VDDPLL	33 - 32	1 µF			±20%	V <sub>DDPLL</sub>	Ceramic X7R
C12	VDD	6 - 39	1 µF			±20%	V <sub>DD</sub>	Ceramic X7R
C14, C16	VDDIO	36 – 37, 9 - 40	1 µF			±20%	V <sub>DDIO</sub>	Ceramic X7R
C6	VBS	38 - 42		100 nF		±20%	V <sub>BS</sub>	Ceramic X7R
C22	VDDPLL	61 - 62		100 nF		±20%	V <sub>DDPLL</sub>	Ceramic X7R
C2	VDDPXH	22 - 42		10 nF		±20%	V <sub>DDPXH</sub>	Ceramic X7R
C11	VDD	6 - 39		10 nF		±20%	V <sub>DD</sub>	Ceramic X7R
C13, C15	VDDIO	36 – 37, 9 - 40		10 nF		±20%	V <sub>DDIO</sub>	Ceramic X7R
L1	VDDPLL	---		100 nH		±20%	V <sub>DDPLL</sub>	Inductor

Table 11: Values of component related to epc635 chip, see16

### Notes:

- <sup>1</sup> All other components are application specific.
- <sup>2</sup> The capacitor value has to be selected according the crystal or resonator supplier's recommendation

## 5.3. Hardware implementation notes

- Decoupling capacitors must be placed as close as possible to their supply pin pair in order to minimise ripple on the supply rails due to fast switching high-speed signals (11).
- +1.8V is used for supplying the digital logic (VDD), the on-chip oscillator OSC and the phase-look-loop PLL (VDDPLL). The digital logic creates some internal switching noise on VDD. When the same supply is shared together with OSC and PLL, their supply wiring must be separated from the digital wires and physically isolated from each other. These supplies are marked in the application diagram as VDD and VDDPLL respectively (16). A good practice is inserting on the PCB a series inductance of 100nH between them close to the supply source, then creating separate supply islands for both on the board. The XTAL/OSC and PLL are critical parts of the chip which directly impacts the optical system performance (i.e. distance calculation).
- +2.5/3.3V is used for supplying the high-speed IO pins (MODCLK, TCMI and LED2) and the slow I<sup>2</sup>C pins (VDDIO). High speed IO pins toggle at 10/20/40/80MHz during data transfer, hence generating continuously switching noise (much more dominant than the digital noise). Therefore VDDIO supply wires and layers must be carefully designed and isolated in a separate supply island on the PCB. It is not recommend to change this voltage on the fly when the TCMI, LED2 or I<sup>2</sup>C interfaces are running. When the application needs power saving during system idle periods, it can be scaled from +3.3V down to +2.5V only after frame acquisition is stopped and both interfaces are completely inactivated. It can be increased back to +3.3V before re-activating the chip for frame acquisition, accessing I<sup>2</sup>C, LED2 or TCMI interface. Note that, voltage scaling must be done in a controlled way having both application CPU's and epc635's IO voltages at the same time at the same level.
- +5V is used for supplying analog blocks of the chip e.g. pixel-field drivers and ADC readout circuitry. Refer to 16.
- +10V is used for supplying pixel-field circuitry (VDDPXH).
- 10V (VBS) is used for biasing the the pixel-field like reverse-biasing a photodiode. The use of a stable supply source with a low ripple is recommended. There is no switching or active internal circuit dependent current consumption, except ambient-light dependent leakage current (refer to 1, note 8).
- A 4MHz quartz crystal or a ceramic resonator is connected to XTALIN\_CLKIN and XTALOUT pins in order to use internal oscillator OSC as time base for the epc635. The frequency accuracy and stability are directly related to the distance readings. Alternatively an external clock source can be used (chapter 5.4.).
- MODCLK input can be used for user controlled/modulated clock. It is used for both the LED driver and the pixel-field demodulator.
- SCL, SDA are I<sup>2</sup>C slave pins which need external pull-up resistors on the PCB (see also VDDIO supply). Values of R16 and R17 are given only for indicative purpose and must be re-calculated according to the total capacitive load of all I<sup>2</sup>C slave/master devices and the operating mode FM or FM+ of the I<sup>2</sup>C (chapter 13.) in the application.

10. VSYNC\_A0, HSYNC\_A1, XSYNC\_SAT, DATA[11:0], DCLK, high-speed TCMI signals (chapter 6.), SHUTTER and  $\overline{\text{RESET}}$  control signals toggle in the VDDIO range. To minimize the skew, the high-speed \*SYNC, DATA[11:0], DCLK signals wires must be routed equal in impedance and length less than 10cm long with less than 10mm difference on the PCB. As they are toggling all the time, they can be separated with ground wires on the side adjacent to other signals/supply lines, routed with enough distance from other sensitive signal wires on the board. Series termination resistors R4 ... R15 (10 ... 33 $\Omega$ ) are needed at high-speed outputs to control the slew.
11. Optional pull-up resistors R18 and R19 (10k $\Omega$ ) set initial values of some configuration registers during start up of the chip. Such outputs pins are called strap pins. They are scanned one time immediately after  $\overline{\text{RESET}}$  is released (chapter 5.6.3.).
12. The LED pin is an open-drain LED/LD driver output. When the driver is active (on), the LED/LD on-current flows through the power resistor R3 into the LED pin, through the driver and comes out of the chip on the VSSLED ground pin. The LED pin toggles up to 20MHz or according to the MODCLK clock with a current maximum of 200mA limited by the resistor R3. The number of IR LEDs depends on the level of the LED supply voltage and the turned-on forward voltage drop of the IR LEDs. This signal creates a lot of ground noise. Therefore, VSSLED pin is decoupled from the other analog grounds internally. It must be shorted with the other analog ground pins with a low-ohmic connection as short as possible on the PCB. In this way, there will be minimal voltage differences in the ground planes of the board. The LED supply line must be isolated properly from any analog supply on the PCB to minimize noise coupling from the LED drivers.

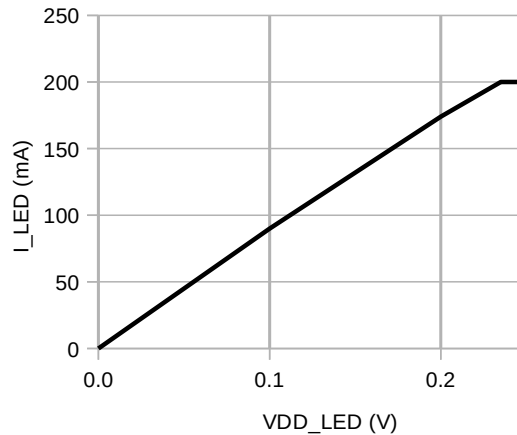

Figure 17: Output characteristic  $I_{LED}$  versus  $V_{DDLED}$ . Refer for maximum values of  $V_{DDLED}$  and  $I_{LED}$  to 1 and 2

13. The LED2 pin is the alternative push-pull driver providing symmetric rise/fall times to drive external LED driver. It works from the +2.5/+3.3 VDDIO supply (VSSIO GND domain) and swings in the same voltage range like the TCMI pins. LED2 = LOW (approx. 0V) corresponds to LED = OFF (max. output voltage). LED and LED2 pins must not be used at the same time for driving the external illumination. They exhibit different phase delays and this can result wrong distance measurements. None of the TCMI pads toggle during integration time, LED2 pin is the only toggling during integration time and it is not affected from switching noise of others.
14. It is recommended having "not connected pins" (PINxx) on test pads available. It helps e.g. to check after assembly for correct orientation of the chip or for short-cuts.
15. Pins not listed here have to be connected according 16.

#### 5.4. Clock source

Instead of a crystal, an external 4MHz clock source can be connected to the XTALIN\_CLKIN pin. XTALOUT output pin left unconnected. Input clock signal levels must match  $V_{DDPLL}/V_{SSPLL}$  supply levels (1). If the external clock source comes from the +2.5/3.3V voltage domain, a resistor divider circuit can be deployed to adjust the voltage level according to 18.

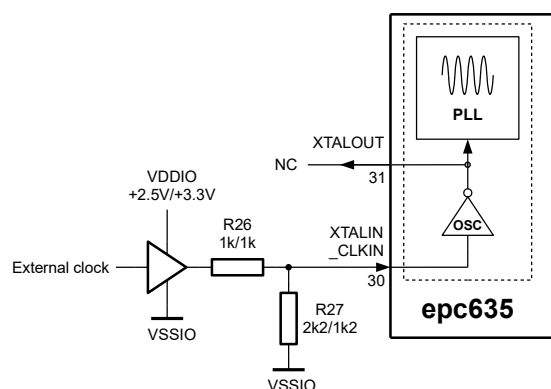

Figure 18: Resistor divider to adjust external clock voltage levels to XTALIN\_CLKIN

**IMPORTANT:** The optical performance of the chip directly depends on the input clock precision/stability. XTALOUT must not be used to drive external loads.

## 5.5. External modulation MODCLK

The epc635 has for enhanced user applications the possibility to bring an external modulation clock to the chip. The optional MODCLK input can be used to inject a user controlled/modulated clock for both the LED driver and the pixel demodulator, see 19.

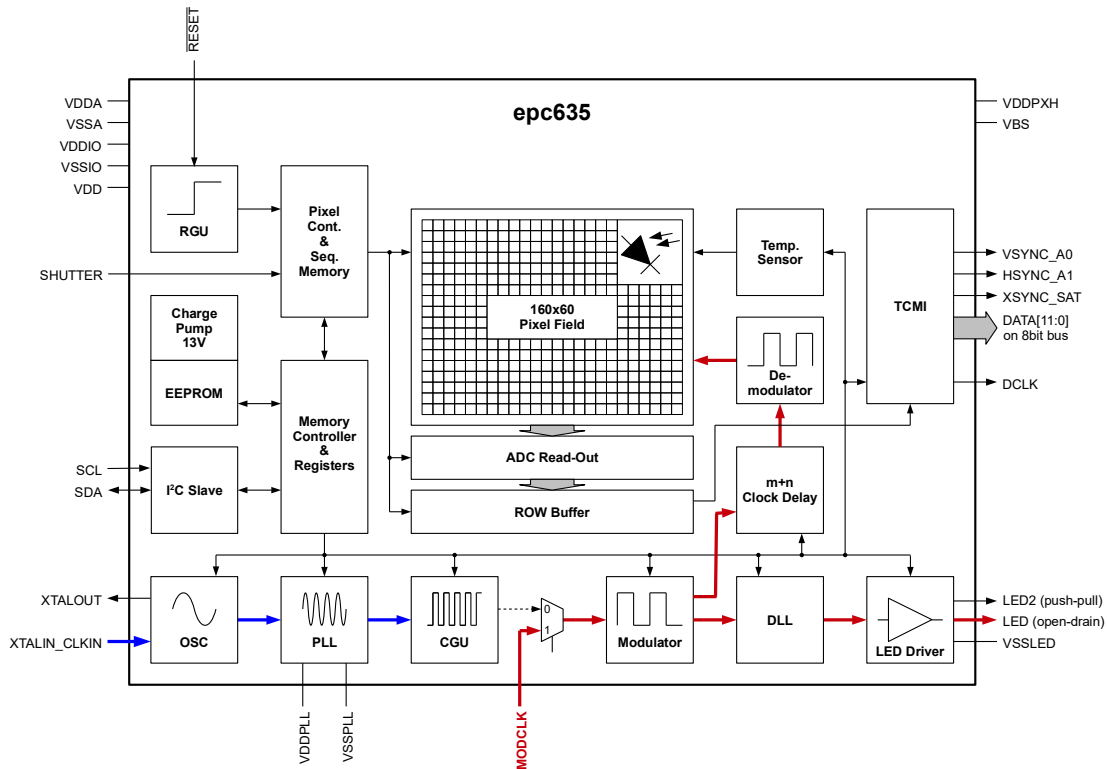

Figure 19: The MODCLK signal flow (red marked)

The external MODCLK can be used e.g. in concepts for reliable multi camera applications. It allows to use e.g. frequency-division multiple access (FDMA). In corresponding literature, the details of these concepts are explained in detail.

The user is free to apply any digital waveform up to 80MHz during frame acquisition as external MODCLK signal. Even more, he is also free to use modulations like pseudo-random edge jitter, dithering, etc.

The signal from the MODCLK pin is used instead of the clock generated by the CGU if bit 6 in register 0x80 is set to 1. The effective modulation signal is the MODCLK divided by 4. The unambiguity range and the integration time are in this case based on the MODCLK:

$$[1] \quad d_{UNAMB} = 2 * \frac{c}{MODCLK}$$

$$[2] \quad t_{INT} = \frac{reg(0x85)+1}{MODCLK} \cdot [reg(0xA2:0xA3)+1] \cdot reg(0xA0:0xA1)$$

Whereas "c" is the speed of light (300\*10<sup>6</sup>m/s). For more details refer to chapter 9.2.1 and 11.4.

## 5.6. Supply, reset and start-up options

### 5.6.1. Supply voltages and external reset

During power-up, VDD and VDDPLL supplies (20) must be applied at the same time to the epc635. VDDIO can be applied either at the same time or after VDD and VDDPLL supplies become stable. In a system where VDDIO voltage is connected in parallel to application CPU IO supply pins (see 16), VDD and VDDPLL can be generated by a linear regulator directly from VDDIO supply. In this case, all these three supplies ramp together.

VDDA and VDDPXH supplies must be applied as a second group, after all VDD, VDDPLL and VDDIO supplies become stable.

The negative supply VBS must be applied after all positive supplies reached their rated levels.

Image acquisition shall not start before all supply voltage are at their stable level.

$\overline{RESET}$  must be kept low while all positive voltages are ramping-up in order to guarantee proper reset of all internal circuits. As soon as rated positive levels are reached,  $\overline{RESET}$  can be set to high. In case of an external clock is applied at XTALIN\_CLKIN instead of a crystal/resonator is used with on-chip OSC, clock must be present before  $\overline{RESET}$  is released.

### IMPORTANT:

- It is possible to shutdown entire supplies for a very low standby current. In that case, first  $\overline{RESET}$  must be driven low, then supplies must be turned off in the reverse order. Refer for details to chapter 11.6.
- VDDA and VDDPXH supplies must never kept on while turning off VDD, VDDPLL and VDDIO. Damage to the chip can be the result.

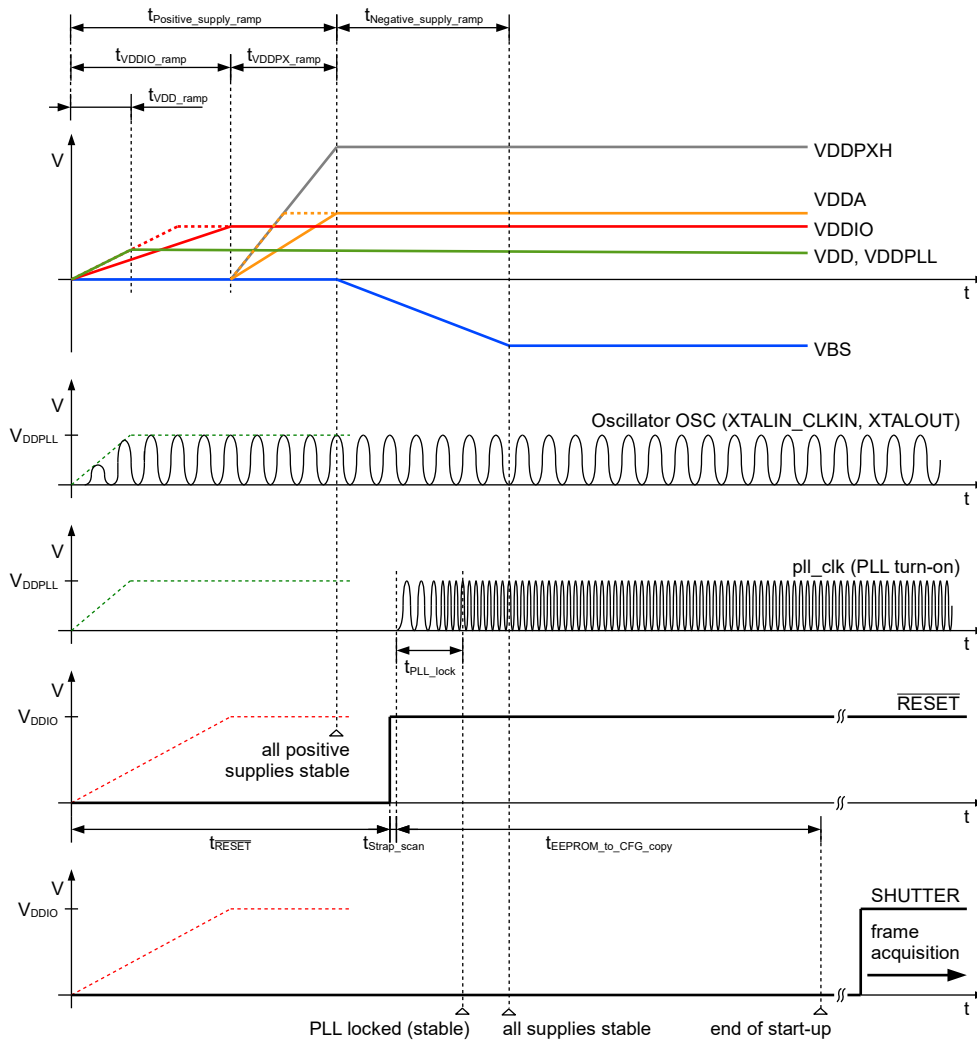

Figure 20: Power-up and reset sequence

### 5.6.2. Start-up (Clock, PLL turn-on and EEPROM copy)

The epc635 starts using either the internal 4MHz oscillator OSC with a crystal/resonator (16) or an external 4MHz clock, followed by an EEPROM copy sequence in parallel to the PLL turn-on phase. This is the factory default configuration. Several configuration registers are modified by copying the EEPROM content (52, i.e. overwrite reset values). The EEPROM copy step takes 340µs after the RESET is released.

### 5.6.3. Strap pins

The epc635 has output pins with dual/alternative functionality for PCB level flexible start-up configuration changing, called 'strap pins'. RESET release is followed by a strap pin scanning step. The chip programs its strap pins as inputs with internal pull-down resistors enabled for 4 osc\_clk periods (refer to 1 and 3). If there is no external pull-up resistor connected, the corresponding strap pin will be scanned as logic 0 due to the internal pull-down resistor. If there is an external pull-up resistor connected (16), it will override the internal pull-down and corresponding pin will be scanned as logic 1. After the strap scan period, pins are programmed back as outputs so that they can be used for their main function. Strap pins and their definitions are listed below (12).

Pin	Pin no.	Definition
HSYNC_A1	35	Set A1 bit of 7-bit I <sup>2</sup> C slave device address (section 13.1.).
VSYNC_A0	34	Set A0 bit of 7-bit I <sup>2</sup> C slave device address (section 13.1.).
XSYNC, DATA0	3, 4	Factory used strap pins. No pull-up resistors allowed

Table 12: Strap pin definition

### 5.7. LED driver

The LED driver register 0x90 is used for setting polarity etc. depending on the external LED/LD circuitry used in the application. These bit fields must not be modified during frame acquisition.

**IMPORTANT:** There are non-modulating DC modes (e.g. grayscale with LED/LD illumination) which keeps the LED driver always turned on. In this case, the user has to take care that LED driver and the epc635 chip does not exceed the maximum operating limits.

### 5.8. DLL (Delay Line)

The modulation signal can intentionally be delayed in order to add a phase shift between the modulation of the light source and the demodulation of the backscattered light, refer to 21.

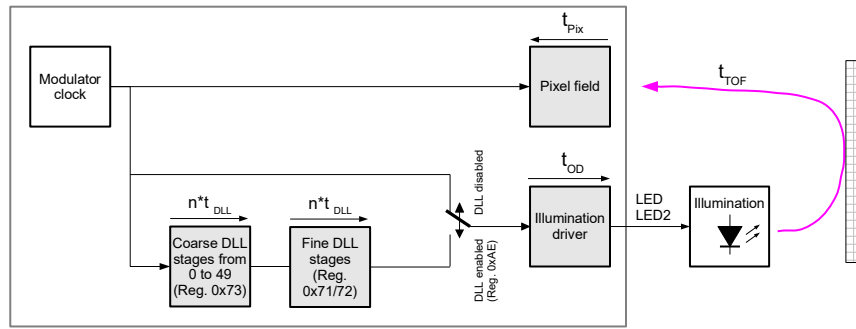

Figure 21: Block diagram of the DLL function

The purpose to do so can be that the phase shift between the modulated and the demodulated signal in a specific distance range should be at a certain value. For example, the highest distance accuracy with lowest distance noise can be achieved when the phase angle of demodulation is 45°. This is the case when all four DCS amplitudes have the same or a similar value. The worst situation is if one DCS pair is at its maximal amplitude whereas the other DCS pair is around zero (refer to 22).

The DLL can be enabled in register 0xAE whereas the delay of the LED modulation can be set in steps  $t_{DLL}$  by register 0x73 (approx. 2ns/step). The exact step  $t_{DLL}$  can be calculated with the value and the formula listed in register 0xE9. This value is varying from chip to chip and is also temperature dependent. The user shall characterize the overall temperature drift of the complete camera for matching the compensation.

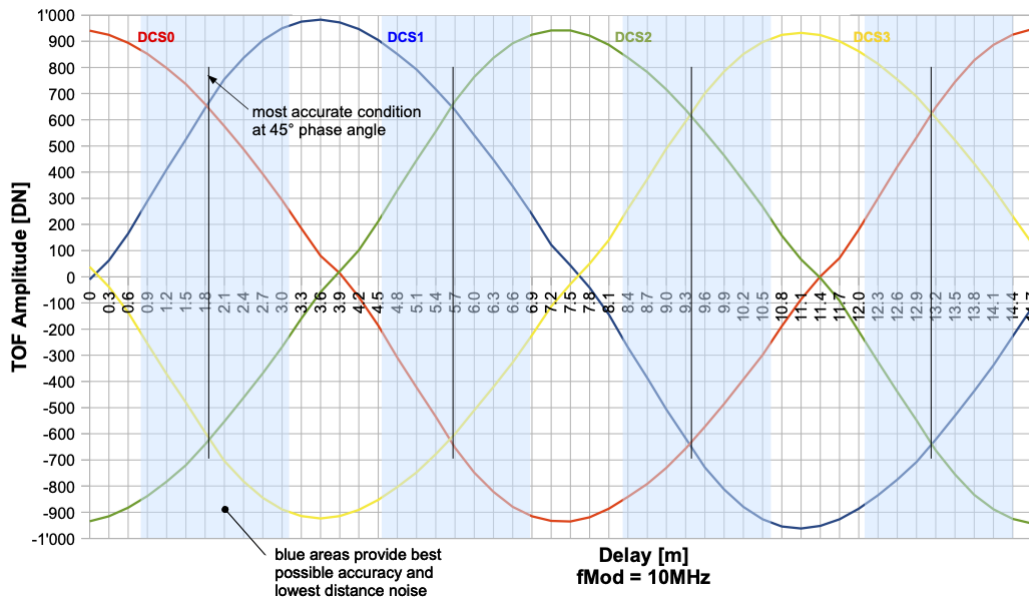

Figure 22: DCS amplitudes for the 4 DCSx (measurement data)

#### Example for 10MHz modulation frequency:

If we want to optimize the accuracy of our TOF camera in the short range domain, e.g. 0m to 1m, the situation shown in 22 is not ideal at all. The modulation frequency of the data shown in 22 is 10MHz whereas 50 DLL Steps of approx. 2ns are equivalent to 15m distance. Shown in the diagram, the worst condition is in the first three DLL steps, which is equal to 0m to 0.9m. From then on, the distance accuracy becomes much better until DLL step 12. In other words, the distance accuracy from distance 0.9m to 3.0m is very good, but not from 0m to 0.9m. In order to be in an accurate distance measurement regime, the DLL should be shifted by 3 steps which means that the LED is delayed by 6ns.

## 5.9. Application system overview

23 and 24 show a typical application block and data flow diagram. The epc635 chip acquires image data, controlled via the I2C interface, and then submits the data via the TCMI to an FPGA or microcontroller. The FPGA or microcontroller calculates the distance from the DCS and does filtering, correction and compensation and provides a cleaned “point cloud” to the host system.

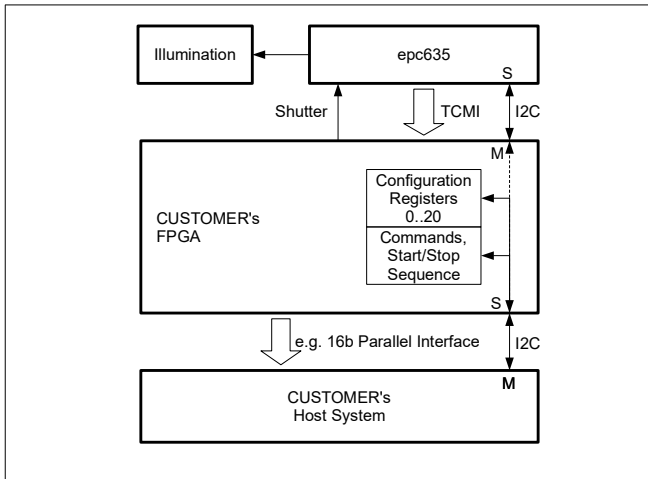

Figure 23: Block diagram

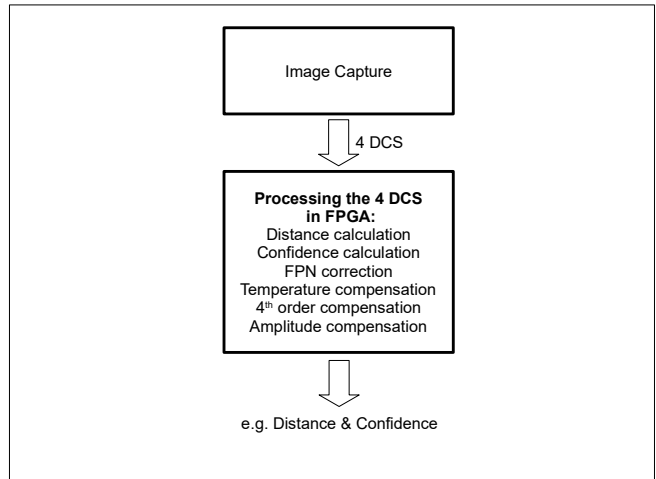

Figure 24: Data flow

## 6. TOF camera interface (TCMI)

The TOF Camera Module Interface (TCMI) is a programmable high-speed parallel data output interface to download the pixel data. It can be programmed very flexible via the registers 0x89, 0xCB and 0xCC.

When the integration period is completed and ADC conversion is finished, the readout results are moved into the data out buffers to be immediately transmitted via the TCMI interface. Depending of the mode selection (4x DCS, 2x DCS, ...) a programmable number of DCS frames are generated. The data is streamed out as a complete block of 1 DCS frame, one after the other. Each row contains 12-bit DCS values and the SAT bit. The pixel values are streamed out as 12 bit signed numbers. The rows are streamed out in sequence from the bottom to the top e.g. R65 (C4, C5, ... C163), R64 (C4, C5, ... C163) and so on until R6 (C4, C5, ... C163). The stream-out of one row takes 16µs with default clock settings (40MHz TCMI clock rate).

The transfer of a DCS frame cannot be interrupted or stopped, once it is started. The application should have enough bandwidth to receive all transmitted frames.

The TCMI supports two clock modes: Continuous clock (default) and gated clock, refer to chapter 6.1.1. and 6.1.2.

**IMPORTANT:** Refer to register 0xCC for setting correct data format.

The application software must take care about negative (-) single ended sample value, accordingly.

### 6.1. TCMI clock

The DCLK frequency which is the clock for the TCMI interface is programmable to 10, 20, 40, 80MHz via register 0x89.

#### 6.1.1. Continuous clock mode

This mode is selected by disabling bit 3 in register 0xCB. The frames are transmitted at high-speed using all \*SYNC (VSYNC\_A0, HSYNC\_A1, XSYNC\_SAT), DATA[7:0] and DCLK outputs (25).

All \*SYNC\*, DATA[7:0] signals are synchronously updated with the positive edge of the DCLK signal when its polarity is set as active-high; with the negative edge of the DCLK signal when its polarity is set as active-low. The non-active edge of the DCLK output can be used by the receiving end (application CPU) as a sampling clock. It should approximately be in the center of the data (refer to 28).

By using the default configuration, the active states of VSYNC\_A0 and HSYNC\_A1 signals indicate blanking periods during the frame transmission. While DCLK toggles continuously, any data during the blanking periods are not valid and must be ignored.

As soon as the measurement result of the first row of the new frame is available, VSYNC\_A0 and HSYNC\_A1 are set consecutively with the next active edge of DCLK. VSYNC\_A0 is active from the start until the end of the each complete frame. Whereas, HSYNC\_A1 indicates the validity of the DATA[7:0] and XSYNC\_SAT (saturation bit) from the start until the end of a row.

By default, the XSYNC\_SAT pin is used for the saturation bit. Optionally, it can be programmed to indicate the end of a frame by disabling bit 6 in register 0xCC.

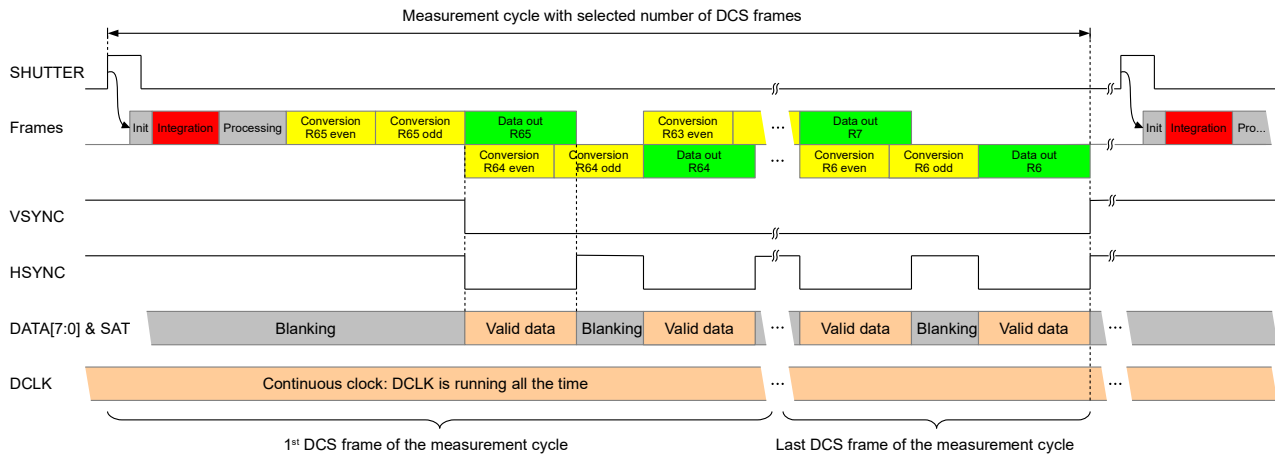

Figure 25: Continuous clock mode

### 6.1.2. Gated clock mode

This mode is selected by enabling bit 3 in register 0xCB. The frames are transmitted at high-speed using only the DATA and DCLK outputs (26). This allows the interfacing to embedded processors with standard parallel GPIOs. The external application must take care of the begin/end of the frame/row.

DCLK signal is generated only during valid data periods. The DCLK toggle duration can be programmed to run few more cycles than HSYNC\_A1 is active effectively. This allows the external processor to finish its last operations with its FIFO/DMA.

All \*SYNC\* signals do not toggle in this mode, but can be optionally enabled.

All \*SYNC\* (optional), DATA[7:0] signals are synchronously updated with the positive edge of the DCLK signal when its polarity is set as active-high; with the negative edge of the DCLK signal when its polarity is set as active-low. The non-active edge of the DCLK output can be used by the receiving end (application CPU) as a sampling clock. It should approximately be in the center of the data.

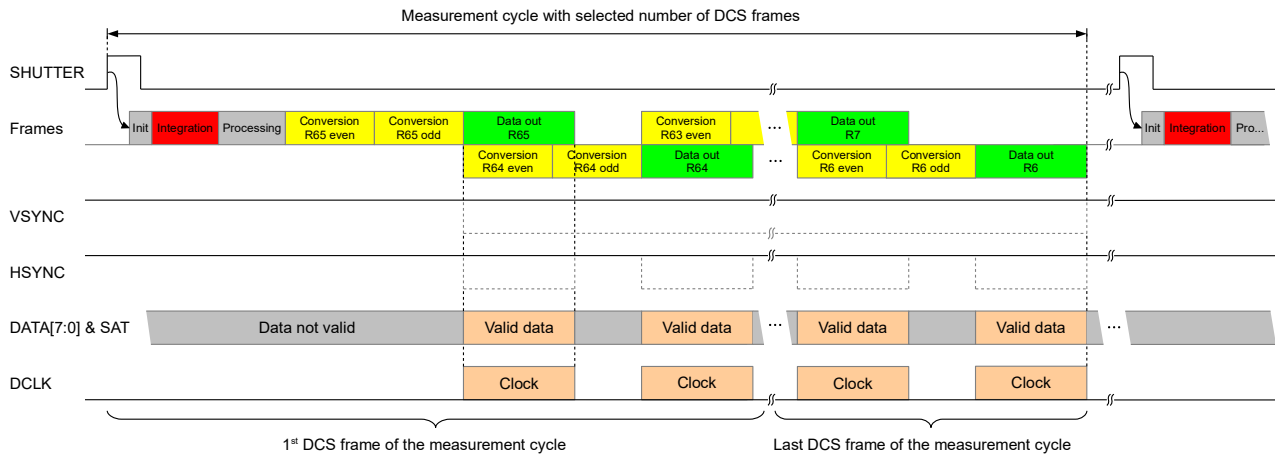

Figure 26: Gated clock mode

## 6.2. Single or continuous measurement control

### 6.2.1. Single measurement control

The selected measurement mode (4x DCS, 2x DCS, grayscale, ...) defines, how many frames the chip performs by the stimulation of one SHUTTER pulse for a measurement cycle. This pulse can be applied either by the HW SHUTTER pin or by SW control with bit 0 in register 0xA4. Whereas the SW controlled SHUTTER is auto-cleared after propagation, the HW Shutter needs a minimum hold time of 250ns and must be set back manually latest before the HSYNC\_A1 signal of the last row pair of the last DCS frame (last HSYNC\_A1 of the last frame). During such a measurement cycle, the next frame acquisition starts immediately after the last data readout on the TCM1 interface until all frames are performed.

### 6.2.2. Continuous measurement control (auto-run)

As long as in the shutter control register 0xA4 bit 1 is set or the HW SHUTTER is applied during the readout of the last row pair of the last frame, the epc635 runs in a non-stop measurement mode. The chip starts immediately next measurement cycle if the actual one is terminated (30). Trigger signals not active during the readout of the last row pair of the last frame are ignored.

### 6.3. TCMI timing

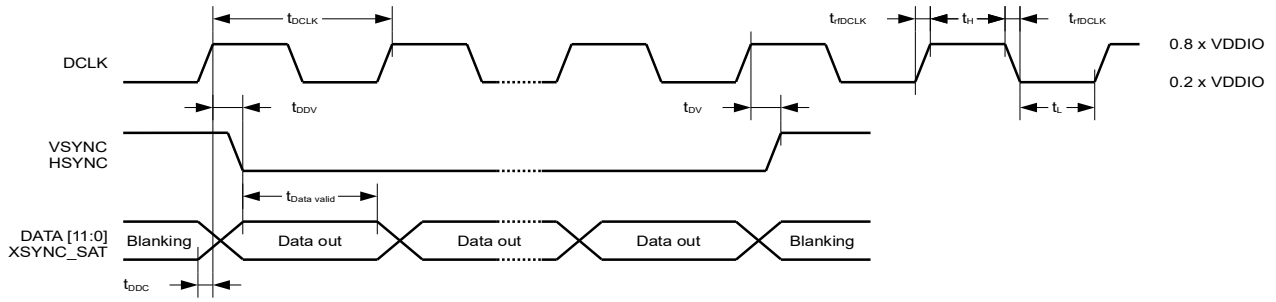
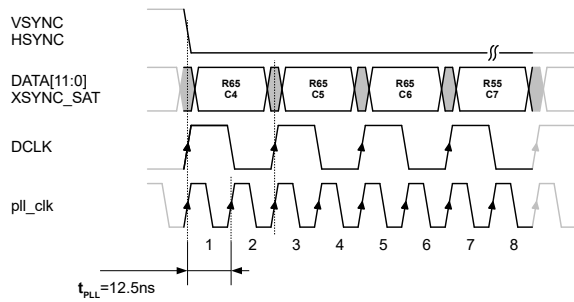

Figure 27: Detailed TCMI timing

Symbol	Parameter	Min.	Typ.	Max.	Units
$t_{DCLK}$	TCMI readout clock: typ. $f_{DCLK} = 20\text{MHz}$ / max. $f_{DCLK} = 80\text{MHz}$ <sup>1</sup>		50	12.5	ns
$t_{DDV}$	Delay time after positive edge of DCLK until data are valid			2.0	ns
$t_{DDC}$	Data start changing before positive edge of DCLK			1.7	ns
$t_{rDCLK}$	Rise and fall time of DCLK, VSYNC, HSYNC, XSYNC, Data[11:0]			2.0	ns
$t_H$	High period of DCLK <sup>1</sup>	5.0			ns
$t_L$	Low period of DCLK <sup>1</sup>	3.5			ns
$t_{Data\ valid}$	Output data on the TCMI interface are valid (depends on DCLK)	8.8			ns

Table 13: TCMI timing parameters ( $C_L = 20\text{ pF max.}$ )

Note 1: Is  $DCLK > 40\text{MHz}$ ,  $t_H$  and  $t_L$  value need to be reduced by 2.5ns for covering safely delay and jitter effects of this output.



TCMI detailed bus timing: DCLK = 40MHz (pll\_clk / 2)

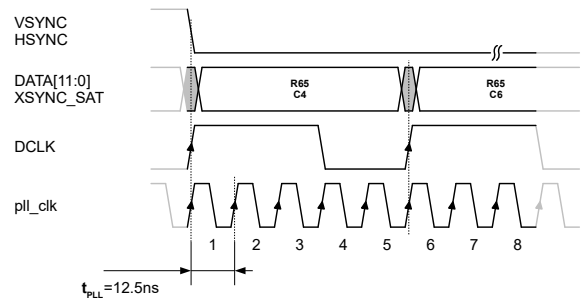

TCMI detailed bus timing: DCLK = 16MHz (pll\_clk / 5)

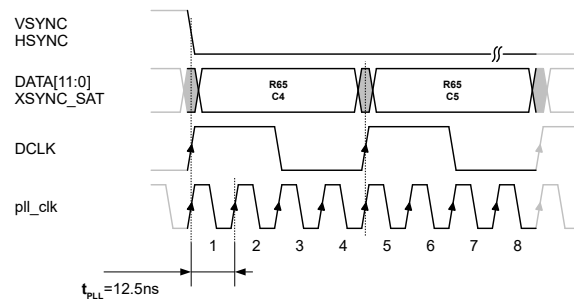

TCMI detailed bus timing: DCLK = 20MHz (default, pll\_clk / 4)

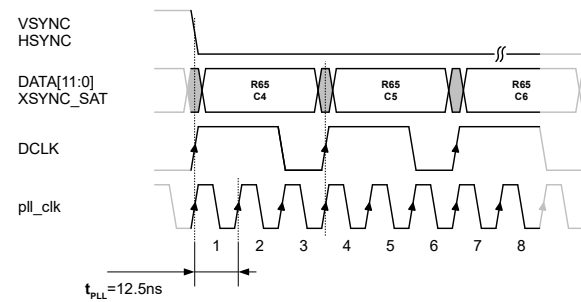

TCMI detailed bus timing: DCLK = 26.6MHz (pll\_clk / 3)

Figure 28: TCMI timing examples with symmetric and asymmetric DCLK



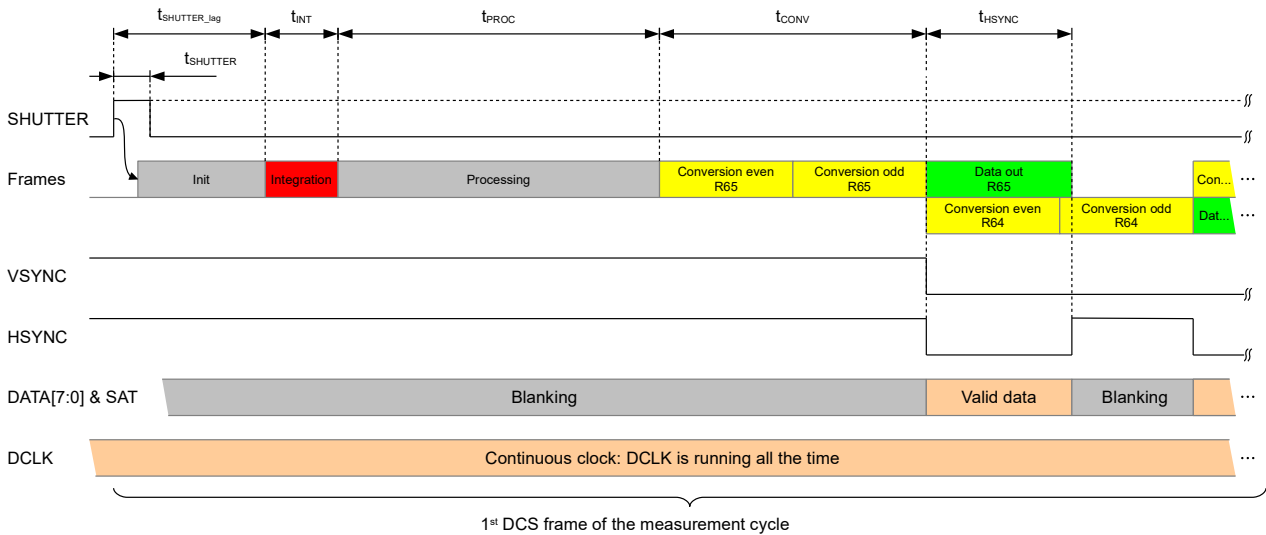

Figure 29: Frame timing: Start 1st DCS frame (DCLK: 20MHz)

**Note:**

To avoid readout rollover when using slower DCLK e.g. DCLK < 5MHz, bit 6 in register 0x91 must be set (refer to chapter 14.2.). It stretches HSYNC for slower TCMI interfaces. It causes a reduced DCS frame rate due to additional  $2\mu\text{s}$  per ADC conversion ( $t_{\text{conv}}/2 + 2\mu\text{s}$ ).

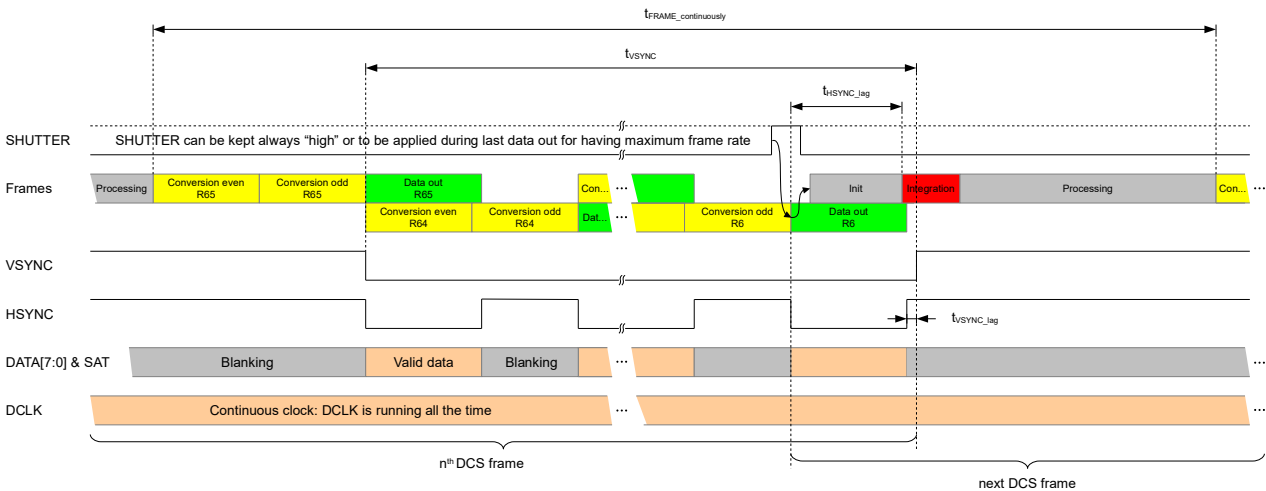

Figure 30: Frame timing: Inter frame timing, end of frame and start next frame (DCLK: 20MHz)

**6.4. TCMI data format**

TCMI supports three 8 bit transfer formats:

- **msb/lsh split mode:** Transfers 12 bit pixel data with MSByte leading and LSByte trailing with 2x DCLK. Refer to 14 and 31.
- **lsh/msb split mode:** Transfers 12 bit pixel data with LSByte leading and MSByte trailing with 2x DCLK. Refer to 15 and 32.
- **8-bit mode:** Transfers the 8 MSB bits of the pixel data with 1x DCLK. Refer to 16 and 33.

The three modes require lines DATA[7:0] to be connected in the application. The TCMI data format can be selected in the register 0xCB. The two split modes transmit pixel values in two consecutive DCLK cycles. As a result, HSYNC time is doubled. When 8 bit precision is enough, the application can use 8-bit mode.

1st Byte: MSByte								2nd Byte: LSByte							
D7	D6	D5	D4	D3	D2	D1	D0	D7	D6	D5	D4	D3	D2	D1	D0
b11	b10	b9	b8	b7	b6	b5	b4	b3	b2	b1	b0	0	0	0	SAT

Table 14: TCMI **msb/lsh** split mode, HW synchronization data format

1st Byte: <b>LSByte</b>								2nd Byte: <b>MSByte</b>							
D7	D6	D5	D4	D3	D2	D1	D0	D7	D6	D5	D4	D3	D2	D1	D0
<b>b3</b>	<b>b2</b>	<b>b1</b>	<b>b0</b>	0	0	0	<b>SAT</b>	<b>b11</b>	<b>b10</b>	<b>b9</b>	<b>b8</b>	<b>b7</b>	<b>b6</b>	<b>b5</b>	<b>b4</b>

Table 15: TCMI **lsb/msb** split mode, HW synchronization data format

Byte							
D7	D6	D5	D4	D3	D2	D1	D0
b11	b10	b9	b8	b7	b6	b5	b4

Table 16: TCMI 8-bit mode , HW synchronization data format

TCMI data formats can be combined with the ADC conversion speed up. Refer to chapter 7 for ADC resolution v.s. conversion time setting.

The saturation flag can be optionally inserted into the DATA[0] of the LSByte by setting bit 6 in register 0xCB during the first or second DCLK cycle for the msb/lbs or lsb/msb split modes, respectively. This feature is not available for the 8-bit mode. In this case either the XSYNC\_SAT pin can be used along with the DATA[\*] pins or bit 7 in register 0xCC must be set to force all DATA[\*] = 0xFFFF when the corresponding pixel is saturated.

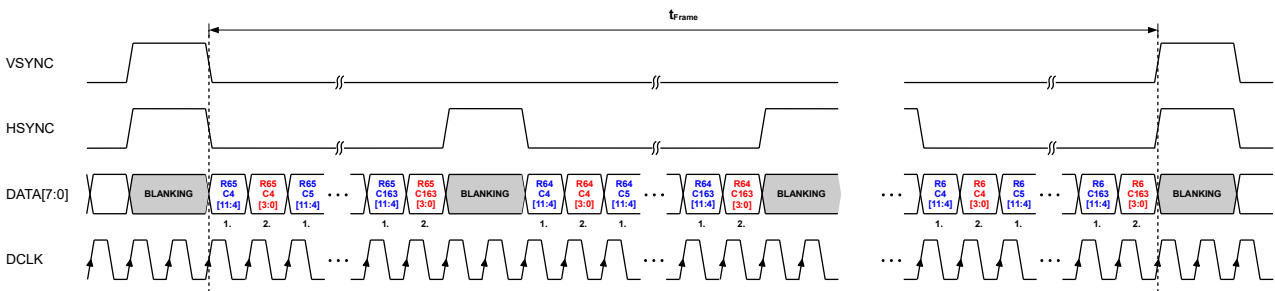

Figure 31: **msb/lbs** split mode

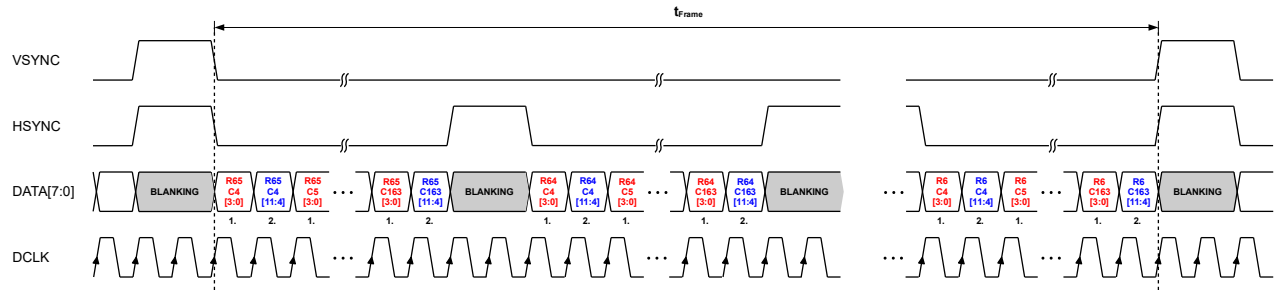

Figure 32: **lsb/msb** split mode

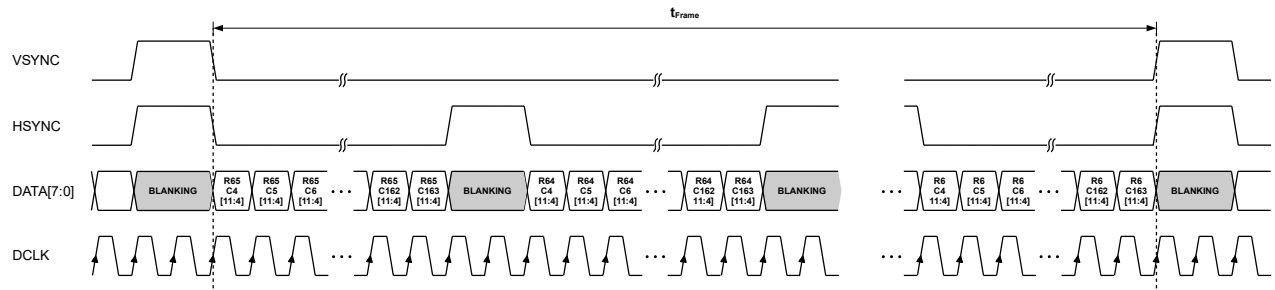

Figure 33: 8-bit mode

### 6.5. TCMI embedded synchronization mode

Embedded Synchronization Mode ESM uses only DCLK and DATA[\*] to transmit the whole image. It eliminates using hardware VSYNC, HSYNC, XSYNC for synchronization. By setting bit 2 in register 0xCB, ESM embeds data packets so called "Labels", before and after every frame and row to mark begin and end of the valid pixel samples on the TCMI data bus. The synchronization labels consist of 4 consecutive bytes, starting always with 0xFF, followed by 0x00, ending with a unique byte as defined designator as given in 17.

Label	4-Byte Data Packet	Description
FS	0xFF 00 00 1E	Frame Start
FE	0xFF 00 00 E1	Frame End
LS	0xFF 00 00 AA	Line Start
LE	0xFF 00 00 55	Line End

Table 17: TCMI ESM labels

The receiver/application continuously parses the incoming data for ESM labels and strips out the image data marked between LS-LE pairs. 34 illustrates an example of a DCS frame transfer. Label ending bytes can be customized by changing the values in the registers 0x1C, 0x1D, 0x1E and 0x1F.

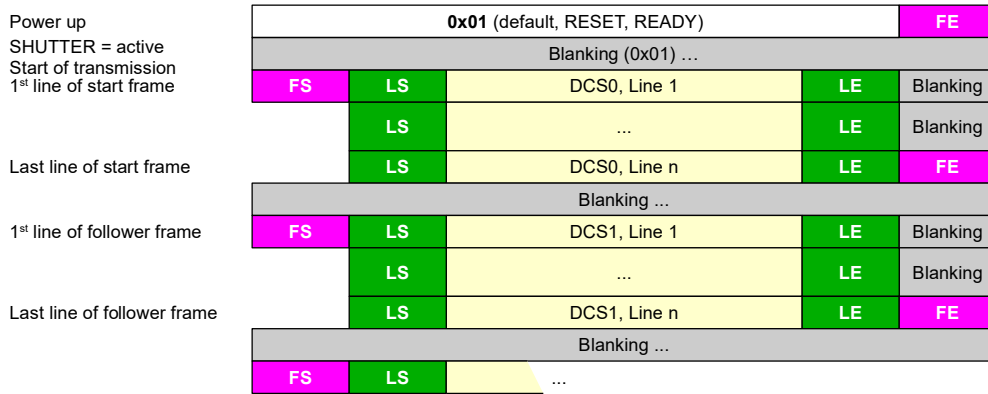

Figure 34: TCMI ESM frames

Values 0x00 and 0xFF will not occur in the image data due to the use of the labels. Therefore, image data is mapped to values between 0x01 ... 0xFE. Is the TCMI bus idle (i.e. blanking), TCMI keeps DATA[7:0] = 0x01 (default value of the bus after reset).

ESM data mapping details for different TCMI data formats are defined in 18, 19 and 20:

D0 ... D7      DATA0, DATA1, ... DATA7 lines of the TCMI bus.  
b0 ... b11     pixel value  
SAT, SAT̄     saturation information

1st Byte: MSByte								2nd Byte: LSByte							
D7	D6	D5	D4	D3	D2	D1	D0	D7	D6	D5	D4	D3	D2	D1	D0
0	1	b11	b10	b9	b8	b7	b6	b5	b4	b3	b2	b1	b0	SAT̄	SAT

Table 18: TCMI msb/lbs split mode ESM data mapping

1st Byte: LSByte								2nd Byte: MSByte							
D7	D6	D5	D4	D3	D2	D1	D0	D7	D6	D5	D4	D3	D2	D1	D0
b5	b4	b3	b2	b1	b0	SAT̄	SAT	0	1	b11	b10	b9	b8	b7	b6

Table 19: TCMI lsb/msb split mode ESM data mapping

Byte							
D7	D6	D5	D4	D3	D2	D1	D0
b7	b6	b5	b4	b3	b2	b1	b0

Table 20: TCMI 8-bit mode ESM data mapping

### 6.6. Frame rate and data-out performance

The epc635 can perform a maximum of 512fps with 1µs integration time, 40MHz modulation clock, 20MHz DCLK, 1x DCS and continuous measurement control. For 3D TOF, each frame is referred as a DCS frame. Either 4x (with π-delay matching) or 2x (without π-delay matching) DCS frames must be acquired for one distance calculation. Therefore, the resulting distance measurement rate turns out to be 128 fps or 256 fps respectively. For the grayscale mode the maximum frame rate of 512 fps is possible.

Symbol	Parameter	Min.	12 bit	8 bit	Units
$t_{DCLK}$	TCMI readout clock e.g. $f_{DCLK} = 20\text{MHz}$		50		ns
$t_{SHUTTER}$	Hold time for the signal on pin SHUTTER	250			ns
$t_{SHUTTER\_lag}$	Delay from the rising edge of SHUTTER signal to the 1 <sup>st</sup> LED pulse		18		$\mu\text{s}$
$t_{INT}$	Image acquisition (integration time)		1		$\mu\text{s}$
$t_{PROC}$	Delay from the last LED pulse until the 1 <sup>st</sup> row conversion		39.25		$\mu\text{s}$
$t_{CONV}$	Conversion time for one row		31.5	24.5	$\mu\text{s}$
$t_{HSYNC}$	Readout time for a row e.g. $f_{DCLK} = 20\text{MHz}$		16	8	$\mu\text{s}$
$t_{HSYNC\_lag}$	Delay from the begin of last readout until the 1 <sup>st</sup> LED pulse of next DCS frame		17		$\mu\text{s}$
$t_{VSYNC\_lag}$	Delay end of HSYNC to end of VSYNC at the end of each DCS frame		50		ns
$t_{VSYNC}$	Data readout time for one DCS frame e.g. $f_{DCLK} = 20\text{MHz}$ $t_{VSYNC} = (t_{CONV} \times 59 \text{ rows}) + t_{HSYNC} + t_{VSYNC\_lag}$		1.874	1.454	ms
<b>Single measurement control mode:</b>					
$t_{1st\_FRAME\_START}$	Delay from rising edge of SHUTTER signal until start of data readout of 1 <sup>st</sup> frame		89.75	82.75	$\mu\text{s}$
$t_{1st\_FRAME\_TOTAL}$	Total time for reading one DCS or grayscale frame from rising edge of SHUTTER signal until end of readout of 1 <sup>st</sup> frame		1.964	1.536	ms
<b>Continuous measurement control mode:</b>					
$t_{FRAME\_continuously}$	Total time for reading one DCS or grayscale frame $t_{FRAME\_continuously} = (t_{CONV} \times 60 \text{ rows}) + t_{HSYNC\_lag} + t_{INT} + t_{PROC}$		1.947	1.527	ms
$t_{4DCS\_continuously}$	Total time for one 3D TOF distance measurement (4 DCS) $t_{4DCS\_continuously} = ((t_{CONV} \times 60 \text{ rows}) + t_{HSYNC\_lag} + t_{INT} + t_{PROC}) \times 4 \text{ DCS}$		7.789	6.108	ms

Table 21: Timings for one DCS or grayscale frames and for 3D TOF distance measurements (4x DCS)  
(Reference: see 29 and 30,  $f_{DCLK} = 20\text{MHz}$ ,  $t_{INT} = 1\mu\text{s}$ )

## 6.7. Memory space estimation

Every frame (DCS) generates up to  $160 \times 60 \text{ pixel} \times 13 \text{ bit (Data + SAT)} = 125 \text{ kBit}$ . Stuffed to 16 bit words, the memory needed to store one DCS frame is 19.2kByte. Depending on the operation mode, up to 10 full frames or even more are needed. Thus, the minimum image memory RAM should be 256kByte.

## 7. Pixel architecture

The pixels are placed in groups 2x2 pixels, called herein “pixel group”. The pixel group performs two basic operations: Measurement (integration) and readout (ADC). Pixels are named as UE (Upper-row, Even-column), UO (Upper-row, Odd-column), LE (Lower-row, Even-column) and LO (Lower-row, Odd-column) depending on their location within the pixel group (see 35). Pixels with the same name are controlled simultaneously in the whole pixel-field. More precisely, pixels in the upper and lower rows are controlled simultaneously during measurement, pixels in the even and odd columns are controlled simultaneously during readout.

The pixel group architecture allows the epc635 to operate the pixel-field in different modes and in combinations thereof according the following chapters.

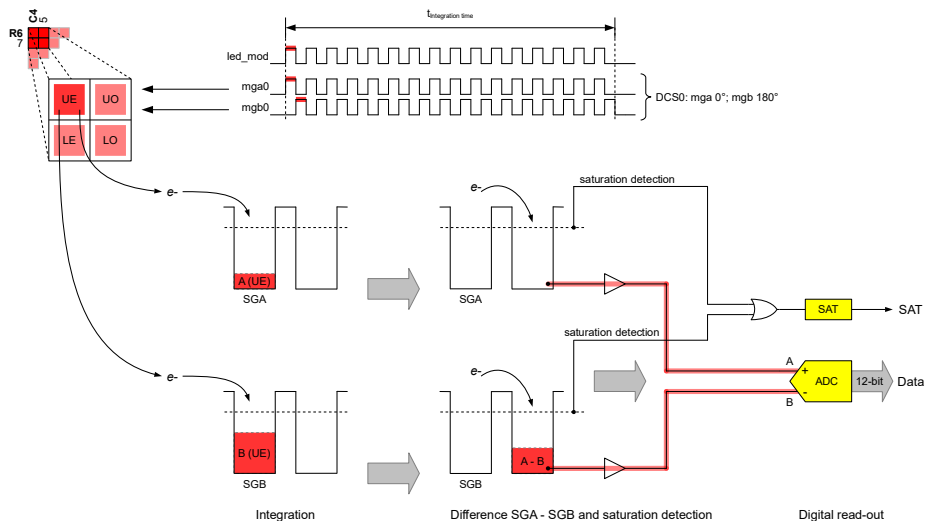

Figure 35: The 2x2 pixel group and the simplified function overview

Each pixel of the pixel group has its own pair of storage gates SGA and SGB. During the integration time, they accumulate the charges (e-) created by the reflected modulated light coming from the object (see section 9., Imaging). They are controlled by the mga and mgb demodulation signals. After the measurement is finished, the readout phase starts. The charges stored in the storage gates SGA and SGB are read out as a difference A – B (ambient-light suppression) and converted into a single 12-bit digital value and a 1 bit saturation flag. The output value can be either positive or negative depending on the demodulated phase and the offset of the signal chain.

## 8. Pixel-field and operation modes

### 8.1. Pixel coordinates

The epc635 pixel-field consists of a total of 168 x 72 pixels whereas 160 x 60 are active. 4 rows top/bottom and 6 columns left/right on the periphery of the pixel-field contain dummy pixels. The upper-left corner (top view on chip) is the origin (4/6) of the epc635 pixel-field. X-axis starts at 4 and counts up to 163 to the right. Pixel y-axis starts at 6 and counts up to 65 to the bottom. All readout modes and control registers use this coordinate system to set or change modes of the chip.

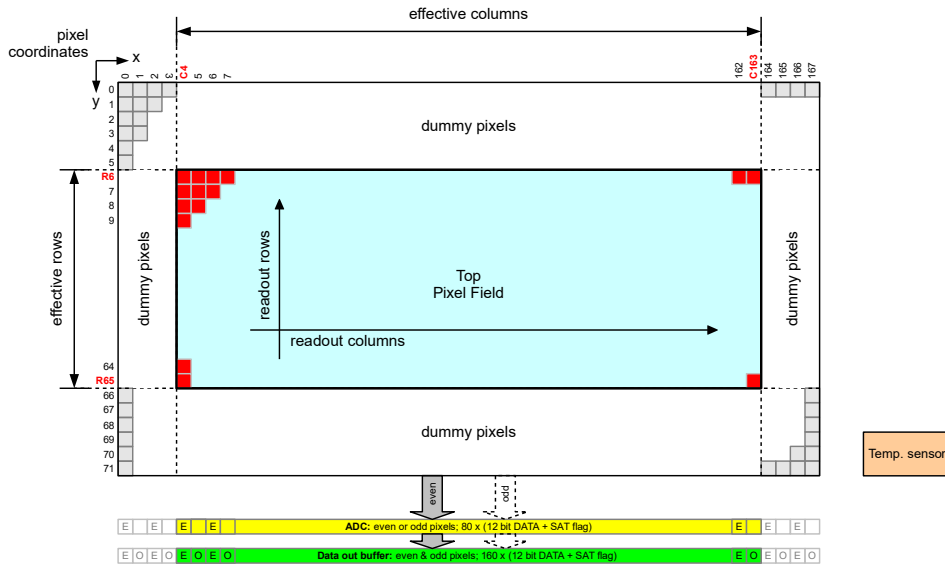

Figure 36: Pixel-field coordinates with row and column numbering scheme (top-view, solder balls are bottom side)

Readout starts at the bottom of the pixel-field and continues towards up, row by row. Thus the higher the row number the more dark current is collected by the pixels which appears like an increased DC offset of the pixel value (refer to 1.4.). The internal readout of a row is split in two sections: first all even pixels; second all odd pixels. Later on the TCMI interface presents the row in the regular order with even and odd pixels mixed.

### 8.2. Operation modes

#### 8.2.1. Full resolution mode (default)

This is the default operation mode for 3D TOF operation. All UE, UO, LE, LO storage gates work simultaneously during measurement operation. The storage gate control signals mga, mgb are applied to all pixels simultaneously (see 37). One, two or four DCS can be acquired in this mode.

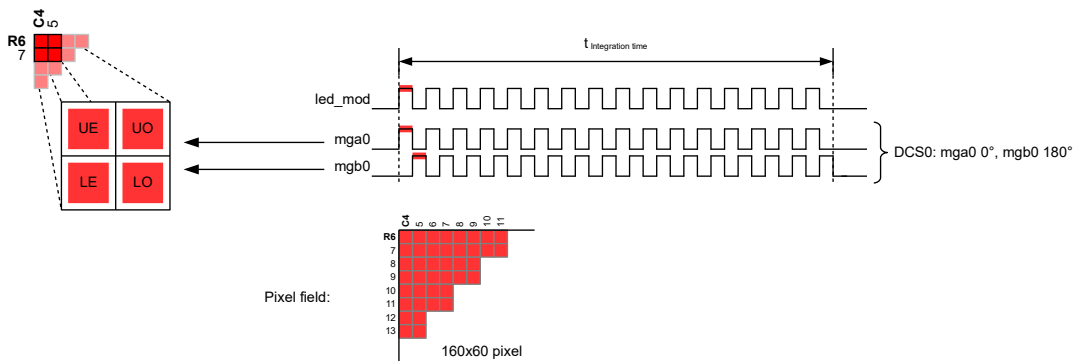

Figure 37: Full resolution mode: even and odd pixel rows are controlled identically with mgx0

#### 8.2.2. Dual phase mode (motion blur reduction)

In this mode, the odd and the even rows are controlled by 90° phase shifted signals (see 38). This mode allows to acquire two 90° shifted DCSs at the same time, e.g. DCS0 and DCS1. In the two-DCS mode, distance calculation can be accomplished within one acquisition. Thus, motion blur is eliminated. The even row pixels store DCS0 (or DCS2) while the odd row pixels store DCS1 (or DCS3). The vertical pixel pairs (e.g. UE/LE) must be treated for distance calculation as if they are one single pixel. This comes at the cost of a reduced resolution along the y-axis. The result provides a total of 160x60 pixel-field readout with an effective 3D TOF resolution of 160x30 pixel.

Select this mode according chapter 11.5.1.

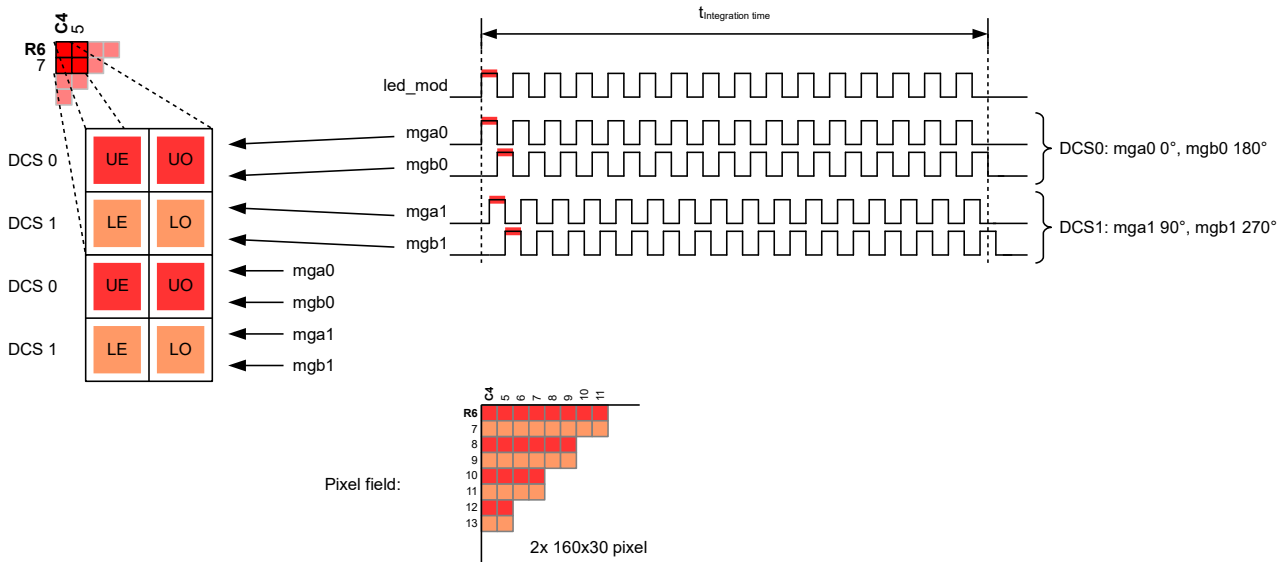

Figure 38: Dual phase mode with phase-shifted integration time even and odd rows independently controlled by mgx0 and mgx1 with different phase shifts

**IMPORTANT:** This mode requires that adjacent pixels look to the same point on the target and receive the same amount of light. Otherwise, calculated distance values are not reliable.

Pixel with a big offset or defective pixel will lead to completely wrong distance values with its paired pixel. Thus, the pixel group has to be discarded.

### 8.2.3. Dual integration time mode (high dynamic range, HDR mode)

In this mode, the odd and the even rows are controlled by different integration time lengths. This mode allows to acquire one image with two different integration time in order to increase the dynamic range. Both groups provide exactly the same DCS modulation signals (phases). One stops earlier than the other due to different integration times (see 39). As a consequence, the two pixels collect different amount of light simultaneously. There is no restriction about which integration time is shorter or longer with respect to the other. The even row pixels integrate with integration length 1, register 0xA2 and 0xA3 while the odd row pixels integrate with integration length 2, register 0x9E and 0x9F. The even and odd pixels (e.g. UE, LE) can be used independently for distance calculation. This comes at the cost of a reduced resolution along the y-axis. Instead of one frame with 160x60 pixels, a single readout provides two DCS or black and white frames with an effective resolution of 160x30 pixels but with different integration times. Select this mode according chapter 11.5.2.

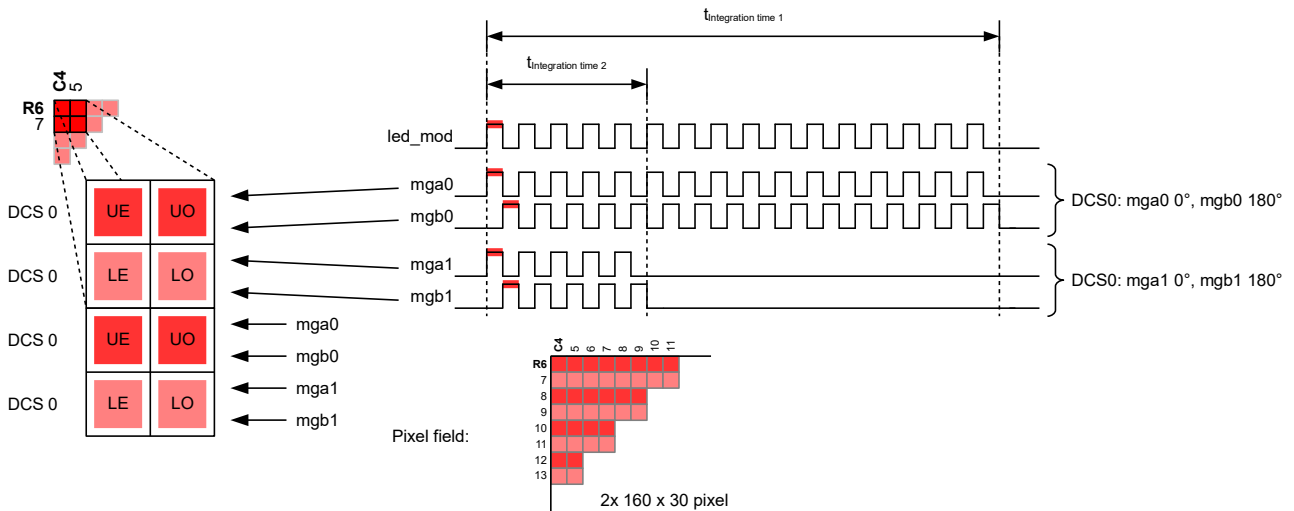

Figure 39: Dual integration time mode: even and odd rows independently controlled by mgx0 and mgx1. One stops earlier than the other

### 8.3. Pixel saturation detection

The pixels collect continuously modulated and non-modulated ambient light during the integration period. Depending on these light intensities, sometimes the pixels collect more charge (over-exposure) than they can accommodate in their storage gates (refer to 35). In such a case, the 12 bit sample data is not valid and cannot be used for distance calculation.

#### 8.3.1. Hardware saturation flag

Each pixel generates a "saturation detection" flag along with the sample data, so that the data can be discarded by the application. The saturation flag is transmitted via XSYNC\_SAT pin with every pixel.

### 8.3.2. Software saturation flag

If XSYNC\_SATpin is used for an another function by setting register 0xCC, bit 6, bit 7 in register 0xCC enables to drive all DATA[11:0] to 0xFF when the pixel is saturated.

### 8.4. ADC conversion speed-up

Applications which need e.g. only 8-bit resolution e.g. grayscale mode, the frame rate can be increased further by reducing the resolution of the ADC conversion. This mode can be combined with the 8-bit TCMI data format by setting bit 4 and 5 in register 0xCB to 11.

Register		ADC Resolution	
Name	Address	8-bit	12-bit
ADC control	0xCD	0x1B	0x13
ADC resolution control	0x9D	0x34	0x50
Conversion time per row		24.5 $\mu$ s	31.5 $\mu$ s

Table 22: ADC resolution setting

# 9. Imaging

## 9.1. Distance measurement (3D TOF)

The epc635's default modulation mode is based on the sinusoidal TOF modulation theory but uses effectively for the illumination a square-wave modulated signal with a duty cycle of 50%. After reset, all internal register values are default to operate the chip at 4MHz XTAL/external clock input, multiplied up to 40MHz at the PLL output, clocks the modulator with 40MHz modulation clock (mod\_clk), modulates LED/LD with 10MHz and acquires 4 successive DCS frames (0 ... 3) using 51.2µs integration time.

The distance measurement mode uses the on chip LED driver and the external LED/LD to provide modulated light on the target. Modulation control signals to the LED driver are provided by a programmable modulator. The modulator generates all signals to modulate the external LED/LD and simultaneously all demodulation signals to the pixel-field. TOF and grayscale mode with all the variants are generated here.

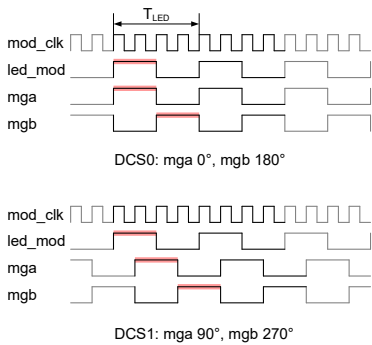

Figure 40: 4 DCSx modulation/demodulation waveforms

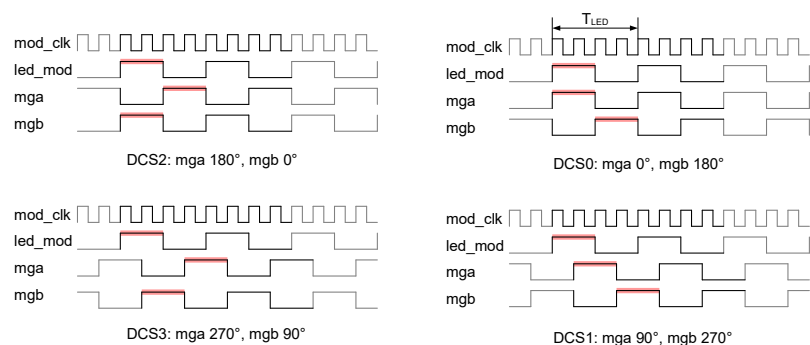

Figure 41: 2 DCSx mod./demod. waveforms

The modulation table registers 0x22 ... 0x2D control the modulation (refer to 37). The registers can be updated via I<sup>2</sup>C bus between frame acquisitions. The application must take care that the last frame's integration phase is completed before modifying these registers on the fly. This time can be detected by the application by waiting for the falling-edge of VSYNC or the first falling-edge of HSYNC signal after shutter pulse/command was applied. This allows to run continuously at the maximum frame rate. For a full-frame readout, the margin is a 3.6ms to alter these registers via I<sup>2</sup>C on the fly.

With the application of the shutter pulse (HW SHUTTER or SW shutter via I<sup>2</sup>C), the chip performs the required number of successive DCS acquisitions. Each one of the 4 DCS frame types has a different phase relation between modulation (led\_mod) and demodulation (mga, mgb) signals which makes phase-to-distance calculation possible. In case of DCS0, led\_mod is phase-shifted by 0° and 180° with respect to mga and mgb, respectively. In case of DCS1, led\_mod is phase-shifted by 90° and 270°. For DCS2, the phase shifts are 180° and 0° and for DCS3, the phase shifts are 270° and 90° (see 40). Note that for DCS2 and DCS3, the demodulation signals mga and mgb are simply swapped with respect to DCS0 and DCS1, respectively.

By programming the number of DCS readouts = 01 (see 0x92 register), shutter initiates 2 successive DCS frame acquisitions (see 41). This mode allows distance acquisition by using two DCSs only and thus a doubled frame rate. However, the cost is a lower distance measurement accuracy and a 40% higher distance noise.



## 9.2. Distance calculation algorithm

The use of the trigonometric atan2 definition for vectors (x, y) in the Cartesian coordinate system  $\varphi = \text{atan2}(x, y) = \text{atan2}(y/x)$  guarantees a continuous distance calculation algorithm in the range of phases between  $-\pi \dots +\pi$ . In our case, we use the range from  $0^\circ \dots 360^\circ$  which corresponds to the distance from 0m up to the unambiguity distance (refer to 42 and 43).

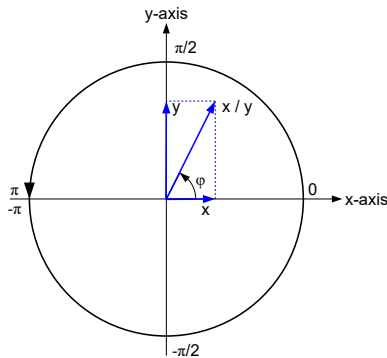

Figure 42: Continuous atan2 representation for the range  $-\pi \dots +\pi$

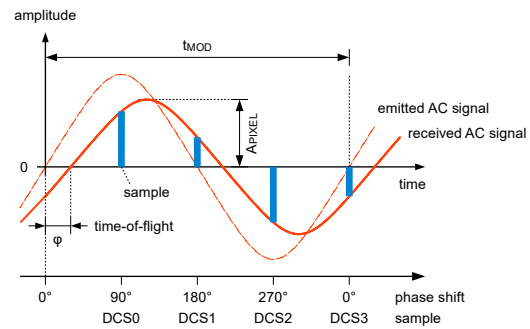

Figure 43: Sampling of the received waveform

Typically, the distance is calculated by using the 4 DCSs, also called  $\pi$ -delay matching which cancels pixels offsets leading to distance errors:

$$[3] \quad D_{\text{TOF}} [\text{m}] = \frac{c}{2} \cdot \frac{1}{2\pi f_{\text{LED}}} \cdot \left[ \pi + \text{atan2} \left( \frac{\text{DCS3} - \text{DCS1}}{\text{DCS2} - \text{DCS0}} \right) \right] + D_{\text{OFFSET}}$$

The measured data are always over the  $360^\circ$  phase-shift valid. Due to the distance offset adjustment  $D_{\text{OFFSET}}$ , the correction of the distance roll-over effect at zero and unambiguity distance is necessary for having all the time correct distance values D:

- if  $D_{\text{TOF}} > D_{\text{Unambiguity}}$  :  $D = D_{\text{TOF}} - D_{\text{Unambiguity}}$
- if  $D_{\text{TOF}} < 0$ :  $D = D_{\text{TOF}} + D_{\text{Unambiguity}}$
- else:  $D = D_{\text{TOF}}$

If higher distance errors can be tolerated but a high frame rate is needed, the distance calculation also works with 2 DCSs only:

$$[4] \quad D_{\text{TOF}} [\text{m}] = \frac{c}{2} \cdot \frac{1}{2\pi f_{\text{LED}}} \cdot \left[ \pi + \text{atan2} \left( \frac{-\text{DCS1}}{-\text{DCS0}} \right) \right]$$

The following terms are used in the formulas above:

$D_{\text{TOF}}$	Distance in meters [m]
c	Speed of light (299,792,458 m/s)
$f_{\text{LED}}$	LED/LD modulation frequency e.g. 10MHz
DCS0 - DCS3	Sampling values [LSB]
$\varphi$	Phase shift caused by the time-of-flight [rad]
$D_{\text{OFFSET}}$	Offset compensation [m]
$D_{\text{Unambiguity}}$	Unambiguity distance [m]

### 9.2.1. Unambiguity range versus time base setting

Due to continuous modulation, roll-over can be observed if the distance to the object is longer than the length of one modulation cycle (one period,  $2\pi$ ). This roll-over distance is called unambiguity range can be calculated as follows:

$$[5] \quad D_{\text{Unambiguity}} [\text{m}] = \frac{c}{2} \cdot \frac{1}{f_{\text{LED}}}$$

The operating range is the maximum distance which corresponds to the maximum time-of-flight inside of one period of the used modulation: it is one period of  $f_{\text{LED}}$ . Objects inside this area are detected unambiguously.

The unambiguity range defines the repetition distance, where objects outside of the targeted operating range can still be detected as far they are of very high reflectivity (remission). Strongly reflected signals outside of this range may therefore interfere with the measurement.

The operating range, the unambiguity distance, the time base for the integration time and the resolution of the distance signal are defined by the modulation clock mod\_clk. This corresponds for the epc635 to a maximum default operating range of 7.5m @ mod\_clk = 80MHz. It may be necessary depending on the application to adapt these parameters to other values. It can be done by a change of the modulation clock. 23 lists as an example some values of the modulation clocks in function of the operating ranges, the unambiguity distances, of the distance resolutions and of the multipliers of the integration time base.

Unambiguity distance	Integration time multiplied by	Distance resolution <sup>2</sup>	Modulation clock	Modulation clock divider	LED modulation frequency
			f <sub>MOD</sub>	Register 0x85	f <sub>LED</sub>
[m]	[#]	[cm]	[MHz]	[#]	[MHz]
7.5	1	0.25	80	0	20
15 <sup>1</sup>	2 <sup>1</sup>	0.50	40	1 <sup>1</sup>	10
30	4	1.00	20	3	5
60	8	2.00	10	7	2.5
120	16	4.00	5	15	1.25

Table 23: Unambiguity range versus on-chip modulation clock

Notes:

<sup>1</sup> Default values

<sup>2</sup> The distance resolution is given for an operating range corresponding to 3'000 LSB.

<sup>3</sup> Using external modulation clock MODCLK: Follow chapter 5.5.

### 9.2.2. Quality of the measurement

The DCS values contain not only the distance information, but also the quality and the validity (confidence level) of the received optical signal. The higher the signal amplitude of the received signal, the better and more precise the distance measurement. Each distance measurement of every pixel has its own validity and quality.

The primary quality indicator for the measured distance data is amplitude of the received modulated light A<sub>TOF</sub>. The amplitude is in direct relationship to the distance noise (refer to Fehler: Verweis nicht gefunden). The amplitude can be calculated as follows:

$$[6] \quad A_{TOF} = \frac{\sqrt{(DCS2 - DCS0)^2 + (DCS3 - DCS1)^2}}{2}$$

Amplitude A <sub>TOF</sub>	Classification	Action
< 25 LSB	Weak illumination	Objects can be detected but distance measurement is not possible. Increase the integration time for the next measurement.
25 ... 100 LSB	Useful for measurement	High distance noise, increase the integration time
100 ... 2'000 LSB	Good signal strength	No action necessary
> 2'000 LSB	Overexposed	Decrease integration time for the next measurement.

Table 24: Signal amplitude versus classification

Note:

The amplitude value is the feedback parameter that is used to set the integration time for the next measurement. Generally, the higher the received signal, the better and more precise the distance measurement. However, it is good practice to control the integration time such that an amplitude value between 200 ... 1'500 LSB is achieved. Higher values will only slow down the acquisition rate due to longer integration times, but are not significantly improving signal to noise ratio.

The quality indicator for the distance noise is the ratio of ambient-light E<sub>BW</sub> to the value of modulated light E<sub>TOF</sub> (AMR). This value may be calculated and used additionally to the above amplitude value if the respective application is subject to intense ambient-light. The irradiance E<sub>TOF</sub> of the modulated signal at the surface of a pixel can be calculated by the AC sensitivity S<sub>TOF</sub>, the used integration time t<sub>INT-TOF</sub>, the reference integration time t<sub>INT-REF-TOF</sub> and the amplitude A<sub>TOF</sub> of the received modulated signal the following way:

$$[7] \quad E_{TOF} = S_{TOF} \cdot \frac{t_{INT-REF-TOF}}{t_{INT-TOF}} \cdot A_{TOF} \quad \text{e.g.} \quad E_{TOF} = 0.60 \frac{nW/mm^2}{LSB} \cdot \frac{100 \mu s}{250 \mu s} \cdot 1'000 \text{ LSB} = 0.24 \mu W/mm^2$$

The formula to calculate the quality indicator "Ratio of ambient-light / modulated light" (AMR) is

$$[8] \quad AMR [dB] = 20 \cdot \log\left(\frac{E_{BW}}{E_{TOF}}\right) \quad \text{e.g.} \quad AMR [dB] = 20 \cdot \log\left(\frac{15.6 \mu W/mm^2}{0.24 \mu W/mm^2}\right) = 36 \text{ dB}$$

To obtain the E<sub>BW</sub> please refer to chapter 9.3. Grayscale imaging. This ratio is one of the influencing factors regarding the distance noise.

AMR value	Classification	Action
< 60 dB	excellent	No action necessary.
< 70 dB	sufficient	Is a lower noise level needed, do the next measurement with a shorter integration time or with an increased illumination power.
> 70 dB	weak	Do the next measurement with a shorter integration time or with an increased illumination power.

Table 25: Classification ratio ambient-light to modulated light (AMR) versus distance noise

There are also validity indicators delivered by the chip after a measurement. These will help to detect saturated or not illuminated pixels as a result of too much/less illumination or too long/short integration time. 26 shows a quality decision matrix as a summary of the validity and quality parameters for the distance measurement.

Step	Indicator	Pixel saturation: too much amb.-light or too bright illu.	Too bright illumination	No object detected	Too much ambient-light	Object detected
1	SAT flag	Set				
2	DCSx		> +99% or < -99%	all of them -1% ... +1%		
3	TOF amplitude		> 99%	< 1%		5% ... 99%
4	AMR: Ratio amb. to mod. light				> 70 dB	< 60 dB
5	Action	Decrease int. time	Decrease int. time	Increase int. time	Decrease int. time	Use distance data

Table 26: Validity (V) and quality (Q) decision matrix (see also to 48)

### 9.3. Grayscale imaging

The grayscale mode allows using the epc635 as a grayscale imager. This mode can be used either without LED/LD illumination for ambient-light measurements or with LED/LD for active illumination of the scenery. The grayscale measurement uses regular DCS measurement but with DCS0 only. It is performed with differential readout using MGA only which stays on all the integration time. Data output format is signed integer 12 bit:  $\pm 2^{047}$  LSB. Effective data range is 0 ...  $+2^{047}$ . Due to system noise around zero, the readout can show small negative numbers. Corresponding registers settings can be found in 0x3A (= 0x00) and 0x3C (= 0x26). Due to the fact that distance measurement results can be influenced by ambient-light, the grayscale measurement without illumination can therefore be used as an important quality and correction parameter for the distance measurement.

The saturation flag status is invalid in this mode.

The irradiance  $E_{BW}$  of the grayscale signal at the surface of a pixel can be calculated from the DC sensitivity  $S_{BW}$ , the used integration time  $t_{INT-BW}$ , the reference integration time  $t_{INT-REF-BW}$  and the amplitude of DCS0 of the grayscale signal as follows:

$$[9] \quad E_{BW} = S_{BW} \cdot \frac{t_{INT-REF-BW}}{t_{INT-BW}} \cdot DCS0 \quad \text{e.g.} \quad E_{BW} = 0.25 \frac{\text{nW/mm}^2}{\text{LSB}} \cdot \frac{100 \mu\text{s}}{1.6 \mu\text{s}} \cdot 1'000 \text{ LSB} = 15.6 \mu\text{W/mm}^2$$

### 9.4. Calibration and compensation of TOF cameras

This modern TOF sensor chip offers a fully digital interface to the control circuitry of a TOF camera. The first time user naturally expects straight forward implementation and digital accuracy of the measured signals. Unfortunately, this is often followed by tremendous disillusion because of the many physical effects influencing the final performance of 3D TOF cameras.

3D TOF cameras capture images by utilizing the time-of-flight measurement of photons. Photons are emitted by high frequency modulated LEDs or Laser Diodes, which are part of the camera, then scattered from objects in the scenery and finally, some of the emitted photons are reflected back to the camera and captured in so-called demodulation pixels. This time-of-flight happens in an incredibly short period of time as it takes place with 300,000km/s or 30cm/ns. If one would like to achieve a centimeter distance resolution and accuracy, 30ps time measurement accuracy has to be achieved. This is a very tough requirement, especially if tens of thousands of pixels shall provide such accurate measurement several dozen times per second at the same time. Small and inherent differences in the connection and arrangement of transistors within the TOF chip, temperature differences and changes, but also irradiance signal strength and last but not least ambient light change lead to measurement errors in the tens of centimeters:

Calibration and compensation is essential to reach the goal.

To support users, ESPROS issued on the Website [www.espros.com](http://www.espros.com) in the section "Downloads" the application note AN10 "Calibration and compensation of Cameras using ESPROS TOF Chips". This paper describes the error sources in 3D TOF sensor chips, a simple way to implement a calibration procedure and how to compensate them on camera level.

Other documents which can be helpful to achieve a successful implementation of the chip are listed in chapter 16.2 Related documents.

### 9.5. Noise reduction and signal filtering

Whatever measurement process is applied, distance noise is one of the major challenging factors of 3D TOF imaging. It limits to distinguish in depth between small objects or fine contours. It is called temporal noise and varies from measurement to measurement. Since this noise is a statistical value, its effect can be reduced by filtering.

However, a simple averaging with a FIR filter is not suitable in many applications because of the very long time lag to get a filtered result. Filtering based on the theory of Rudolf E. Kalman, noise can be reduced significantly without losing responsivity of the system. 44 shows the resulting effect of such a Kalman filter.

Left side: The frames 0 to 120 have been acquired without filtering at all. The distance noise is approx. 12cmpp (1 sigma = 2.5cm). Right side: Frames 121 to 250 are processed with the Kalman filter. The distance noise is reduced to approx. 2cmpp (1 sigma = 0.5cm). The signal amplitude was quite low in both cases, approx. 250 LSB.

To support users, ESPROS issued on the Website [www.espros.com](http://www.espros.com) in the section "Downloads" the application note AN12 "Distance Noise Reduction with Kalman Filter". This paper describes background and implementation of two Kalman filter algorithms in 3D TOF cameras.

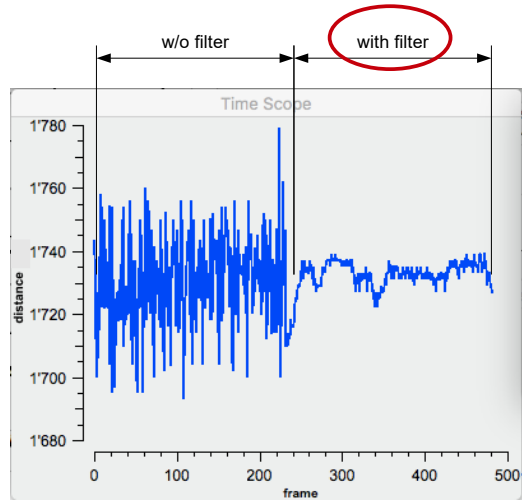

Figure 44: Effect of the static Kalman filter on distance noise (Distance in mm)

## 10. Temperature sensor

The temperature sensor is located near the pixel-field. It is factory calibrated at 27°C (offset). The temperature value can be accessed in registers 0x60 and 0x61 after taking a grayscale image. The sensitivity for taking the grayscale image with the procedure described below is 2.5 times lower compared to the regular grayscale modes described in chapter 11. Most applications need grayscale (or ambient-light) pictures for background-light compensation. By reading the temperature, a grayscale image can be read at the same time.

### 10.1. Initialization

upon power-up or after a RESET:

```
define X, Y, M, C, Z,           # Define required variables
    TH, TL, Temp                # Define required variables, only for temperature reading

X = RD @0xD3                    # Save register 0xD3
Y = RD @0xD5                    # Save register 0xD5

C = RD @0xE8                    # Read sensor factory calibration
Z = C/4.7-0x12B                 # Normalized calibration value for temperature formula

# Set defaults for grayscale
WR @0x3C = 0x26                 # Ambient only (default factory setting)
WR @0x3A = 0x00                 # Differential readout (default factory setting)
```

#### Note:

The registers 0xD3, 0xD5 are factory set registers (trim registers). To achieve an optimal temperature sensing, these registers have to be modified before temperature reading. Afterwards, their original contents have to be restored. This procedure is described above. If these registers are accidentally overwritten, the chip will not work anymore properly. However, the original content of these registers is stored in the EEPROM. By applying a reset, the original content is restored and the chip will work as expected.

### 10.2. Read-out during runtime

1. Set the integration time for the grayscale image the regular way. Note: The sensitivity is 2.5 times lower than in the regular grayscale mode.
2. Acquire a grayscale image, do the temperature readout and the temperature calculation. The grayscale image will be acquired with the following procedure and stores the temperature value into the registers 0x60 and 0x61.

```
M = RD @0x92                    # Save mode register, control no. of DCS

WR @0xD3 = X OR 0x60            # Set bits b5 and b6
WR @0xD5 = Y AND 0x0F           # Clear bits b4 and b5

# Image acquisition
WR @0x92 = 0xC4                 # Change mode to grayscale
WR @0xA4 = 0x01                 # Trigger image acquisition
                                # (can also be done with a hardware shutter pulse)

# Wait until the image is transferred (VSYNC goes high)
TH = RD @0x60                   # Read temperature sensor high register
TL = RD @0x61                   # Read temperature sensor low register

# Switch back to normal image acquisition...
WR @0xD3 = X                    # Restore register 0xD3
WR @0xD5 = Y                    # Restore register 0xD5
WR @0x92 = M                    # Change back to the mode before temperature reading
```

### 10.3. Calculate temperature in °C

```
Temperature = (TH*0x0100+TL-0x2000)*0.134+Z
```

**Note:**

The grayscale image which has been acquired can be used. However, the sensitivity during this acquisition was reduced by a factor of 2.5. Thus, if the same sensitivity should be needed, the integration time has to be increased with a multiplier of 2.5.

If the temperature reading used for compensation purposes, it is recommended to apply the following temporal filtering algorithm. This prevents the compensation of additional noise caused by the temperature reading noise (digitalization, quantization errors and system noise).

```
k = 0.1 # Kalman gain
y[i-1] = x[0] # Start condition

x[i] = Temp
y[i]=k*x[i]+(1-k)*y[i-1] # Simple Kalman 1 filter
```

x[i]: Current temperature

y[i]: Current temporal filtered temperature

y[i-1]: Previous temporal filtered temperature

# 11. Application information

## 11.1. Start-up and initialization sequence

### 11.1.1. Default

1.  $\overline{\text{RESET}} = 0$
2. Apply all supplies (chapter 5.6.1).
3.  $\overline{\text{RESET}} = 1$
4. Continue when copying from EEPROM to CFG is finished.
5. Write pixel sequencer code to memory (chapter 15.10).
6. Enable LED preheat (chapter 1.6).
7. Set registers as shown in 27:

Address	Set to	Comments
0x7E	bit 0 = 1	Read this register for a feedback if EEPROM to CFG copied
0x90	bit 3 = 1	Enable LED Preheat
0xAB	0x01	
0xAE	0x04	Enable DLL
0x80	0x00	Disable internal clk
0x82	0x09	Set PLL FB clock divider
0x85	0x00	Set MOD clock to 10 MHz
0x86	0x04	Set SEQ clock divider
0x87	0x00	Set REFGEN clock divider
0x89	0x01	Set TCMI clock to 20MHz
0x8A	0x01	Set EE CP clock divider
0x80	0x3F	Enable internal clk

Table 27: Additional register settings during startup

### 11.1.2. Customer specific

- Set modulation clock to external.
- Set custom I<sup>2</sup>C slave address with strap pins (chapter 5.6.3).
- Set TCMI mode and polarity.
- Set integrated LED driver according to used illumination.
- The registers as shown in 28:

Address	Comments
0x80	Enable internal clk and external modulation clock. Set therefore address 0x80 to 0x7F.
0xCB	I <sup>2</sup> C and TCMI control
0xCC	TCMI polarity settings
0x90	LED/LED2 driver control

Table 28: Customer specific register

Note:

With internal modulation frequency up to 10 MHz in an operating temperature range of -40 - +105°C is supported. If a higher (internal) modulation frequency is required, the operating temperature range is limited to 0 .. 85°C. External modulation frequency  $f_{\text{MODCLK}}$  is fully supported over the full operating temperature range. Refer to Chapter 5.5.

## 11.2. Image acquisition

1. Select measurement mode (chapter 11.5.2). By default, TOF 4 DCS is set.
2. Set integration time.
3. Start frame acquisition by sending shutter signal.
4. Receive frames from TCMI interface.
5. If needed, get temperature by taking a grayscale image (chapter 10.2).

Note:

For corresponding I<sup>2</sup>C communication examples refer to chapter 13.4.7.

## 11.3. 3D TOF distance measurement flow

A 3D TOF distance image will be done with different steps according to 45. Both interfaces of the epc635 are used: The I<sup>2</sup>C for configuration, mode selection and temperature reading (blue marked in the following figures) and the high-speed TCMI for reading the frame data (red marked in the following figures). The sequence starts with the initialization of the epc635 registers with the necessary and correct configuration parameters. Next, the TOF measurement with the expected mode (4 DCS or 2 DCS) will be performed. Depending of the application and the ambient conditions (ambient-light, changing temperature conditions), the TOF measurement needs some compensation. For the purpose of more accurate ambient-light compensation, a grayscale measurement without illumination captures the background light level. Reading of the on-chip temperature sensor (from time to time) helps to compensate thermal influences caused by e.g. the LEDs, the optical filters and the epc635 chip. After the rearrangement of the grayscale image to the correct pixel orientation, the final 3D TOF distance image can be calculated with the necessary compensation.

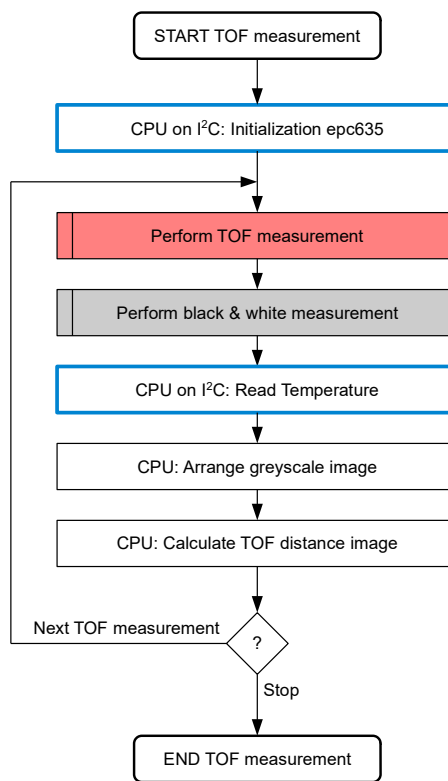

Figure 45: Generic 3D TOF distance measurement flow

The process flow for distance measurements and for grayscale images are similar, see 46. The main difference is the mode selection (number of DCS or grayscale, see register 0x92) and depending thereof the number of frames, which need to be read out during a process cycle. After mode setting, the cycle will be started by applying the SHUTTER signal. Once SHUTTER activated, the epc635 executes the measurement until the end of the sequence automatically.



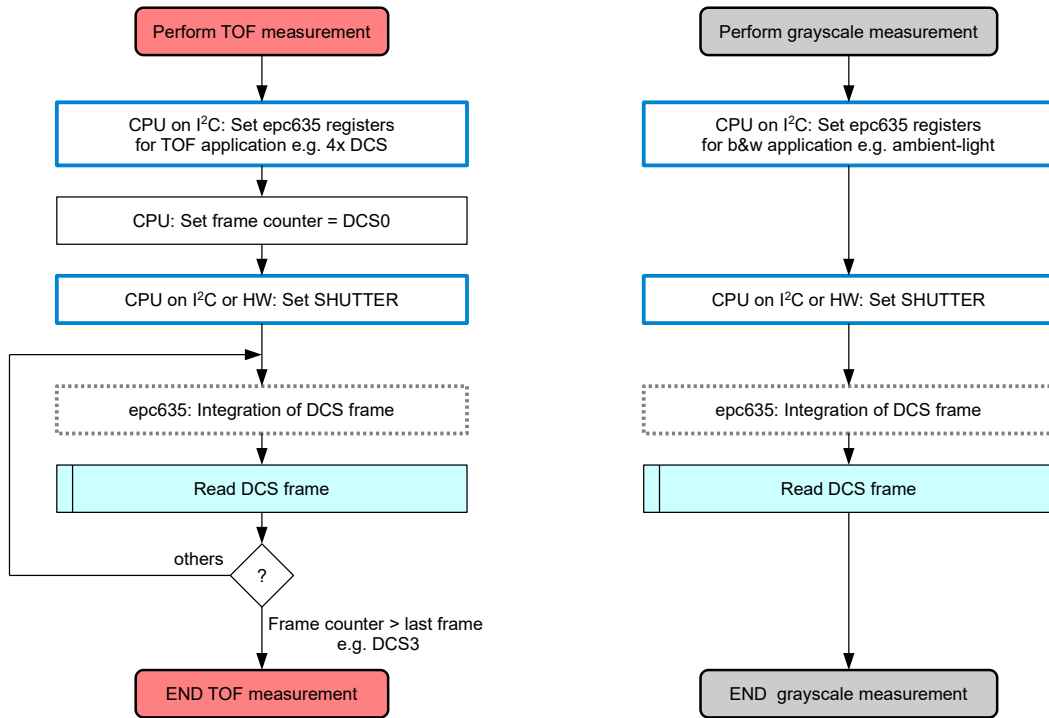

Figure 46: Generic sequences for the distance (TOF) and the grayscale measurement

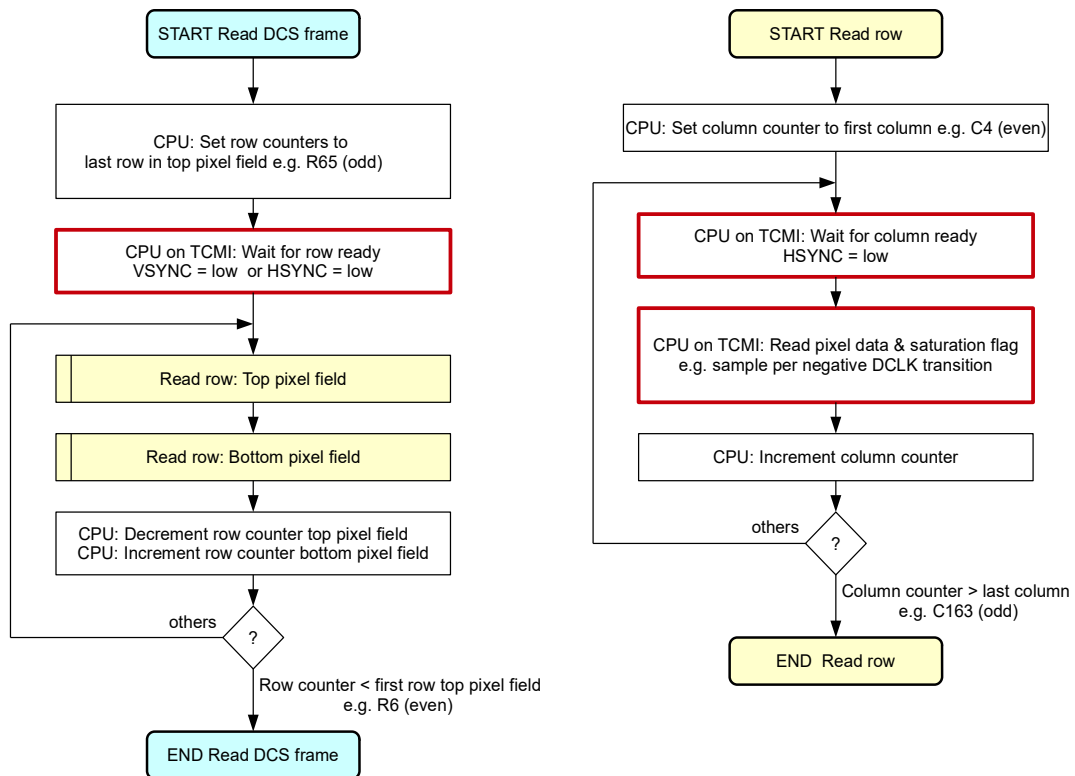

Figure 47: Generic sequences to readout frames and row by row

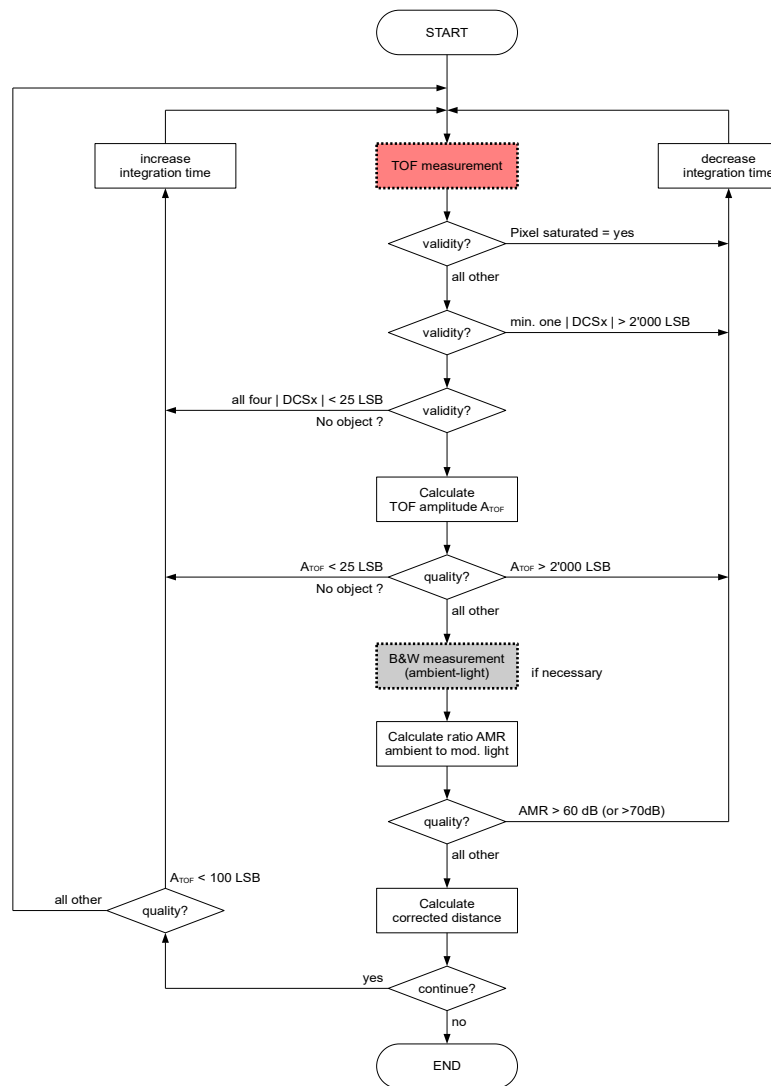

Figure 48: Generic validity and quality flow chart for a single pixel

The generic procedure to readout frames or rows is independent of the selected mode. The application is driven only by the TCMI interface during these phases. To catch the begin of the frame, the application CPU has to wait after the measurement starts until the integration period is finished and the first frame of data is available. The epc635 signals this by setting VSYNC and HSYNC active. Pixel data can be read DCLK by DCLK as long the HSYNC signal is active. Refer also to 29 and 30. The application has to take care to update synchronously all necessary frame, row and pixel readout counters during the measurement cycle.

#### 11.4. Integration time setting

The integration time is the active frame acquisition period (see 29). Specially for moving objects or cameras, this time should be as short as possible to reduce or eliminate motion blur effects. The integration time together with the illumination intensity also defines the effective achievable operating distance. Using the on-chip modulation clock, the integration time can be calculated as

$$[10] \quad t_{INT} = \frac{\text{reg}(0x85)+1}{80\text{MHz}} \cdot [\text{reg}(0xA2:0xA3)+1] \cdot \text{reg}(0xA0:0xA1)$$

29 lists some useful integration time settings.

Integration time	Registers (0xA0:0xA1)		Registers (0xA2:0xA3)	
	[DEC]	[HEX]	[DEC]	[HEX]
1.60 μs	1d	0x0001	63d	0x003F
12.8 μs	1d	0x0001	511d	0x01FF
102.4 μs	1d	0x0001	4'095d	0x0FFF
819.20 μs	1d	0x0001	32'767d	0x7FFF
1.6384 ms	1d	0x0001	65'535d	0xFFFF

Table 29: Typical TOF and grayscale integration times for 10MHz on-chip modulation frequency (modulation clock = 40MHz)

### 11.5. Special mode setting

In this chapter, the user will find the register setting tables for using special modes. Detailed descriptions are given in the corresponding chapters of these modes; see chapter 8., Pixel-field and operation modes.

#### 11.5.1. Dual phase mode (motion blur reduction)

- This mode needs the following basic setting of the register 0x94 = 0x80, register 0x22 = 0x34 and register 0x25 = 0x3E.
- Reset the registers to the default values after leaving this mode: register 0x94 = 0x00, register 0x22 = 0x30 and register 0x25 = 0x35.

Function	Register 0x92	Comments
4x DCS	not applicable	
2x DCS	0x14	Output is effectively 4x DCS in 2 DCS-frames.
Grayscale	not applicable	

Table 30: Setting basic dual phase mode

#### 11.5.2. TOF and grayscale single DCS acquisition with 2 different integration times (High dynamic range)

- This mode needs the following basic setting of the register 0x94 = 0x80.
- Reset the register to the default value after leaving this mode: register 0x94 = 0x00.

Mode	Register setting		Comments
	Register 0x92	Register 0x3C	
4x DCS	0x3C	0x26	
2x DCS	0x1C	0x26	
Ambient only	0xCC	0x26	Grayscale imaging, no active illumination
Ambient & non modulated LED/LD	0xCC	0x16	Grayscale with DC illumination
Ambient & modulated LED/LD	0xCC	0x06	Grayscale with modulated illumination

Table 31: Measurement mode setting for high dynamic range TOF and grayscale

### 11.6. Power consumption

The epc635 has several power states/levels during the different operation phases which are shown in 32 and Fehler: Verweis nicht gefunden.

Power state	Power [mW]	Operation description
RESET	40	All supplies are ON, RESET = 0, Oscillator is ON, PLL and all system system clocks are OFF
READY	110	RESET = 1, PLL and all system clocks ON, waiting for SHUTTER
INTEGRATION	270	SHUTTER pulse/command
CONVERSION	350	Integration finished, conversion of rows
CONVERSION + DATAOUT	320	Transmit row data via TCMI while converting next row
DATAOUT	250	Transmit last row data via TCMI

Table 32: Typical average power consumption levels at different operating states (integration time < 5ms)

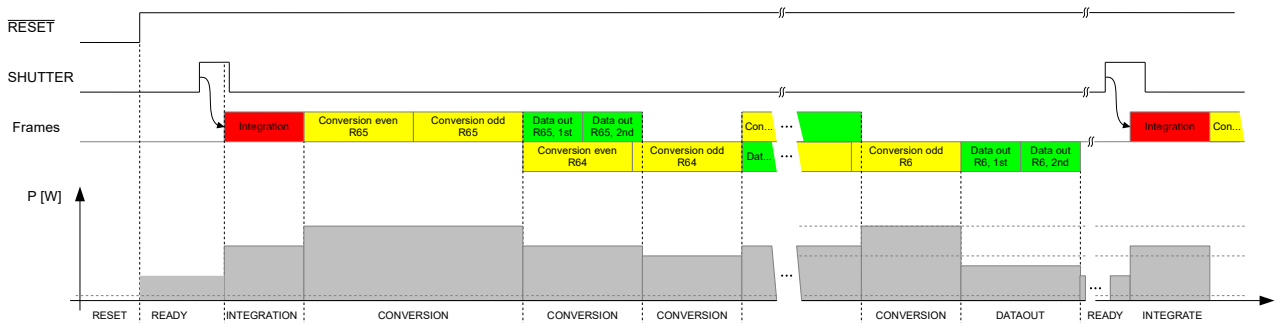

Figure 49: Power consumption levels and operating states

For power critical applications e.g. battery powered systems, it is possible to enforce the epc635 to go in so-called power saving states.

No.	Register			Description
	Name	Address	Value	
<b>Power down</b>				
2	Power control	0xA5	0x00	Switch off of unnecessary supplies
3	Clock control	0x80	0x00	Switch off of unnecessary clocks
4	Mode control	0x7D	0x14	Switch system clock to XTAL clock
5	Mode control	0x7D	0x10	Switch off PLL
<b>Power up</b>				
7	Mode control	0x7D	0x14	Switch on PLL
8	<b>Wait &gt; 32µs</b>			<b>Wait until PLL stable</b>
9	Mode control	0x7D	0x04	Switch system clock to PLL
10	Clock control	0x80	0x3F	Switch on the clocks again
11	Power control	0xA5	0x07	Switch on the supplies again
12	<b>Wait until supplies are stable</b>			
13	<b>Regular 3D TOF operation</b>			

Table 33: Sequence for the SW POWER DOWN mode

### 11.7. Rolling DCS frames

In special applications, it is possible to use all the time the same integration time in continuous distance measurement mode without any grayscale images for ambient-light compensation. Such a set-up allows enhancing the distance measurement rate by a factor of 4 by using rolling DCS frames.

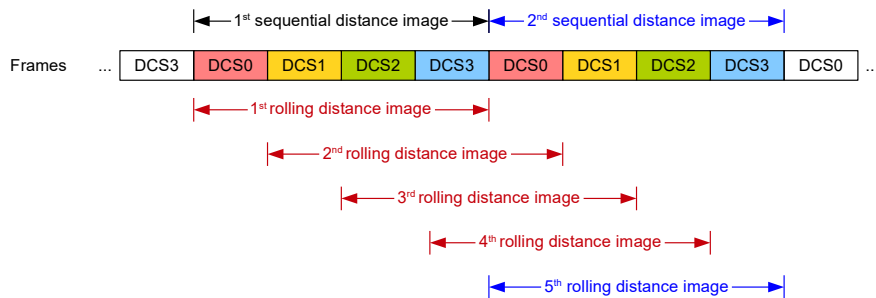

Figure 50: Rolling DCS frames

As shown in 50, the algorithm performs with each new DCS frame a new distance calculation based on the new and last three DCS frames.

### 11.8. Enhanced rolling DCS frame mode

epc635 allows to set for each single DCS access own parameters. This opens the possibility to acquire in time-sequence DCSx frames with e.g. different integration times.

The enhanced rolling mode combines all:

The stacking of integration times to enlarge the dynamic range, the acquisition of an ambient-light image for correction and the rolling mode to speed up the frame rate.

The final distance frame acquisition will be in an equidistant time manner e.g. for 2 or more different integration times.

Select out of the acquired integration time distance frames, already compensated, each time the most reliable distance information for the final composed distance picture

The following example shown here is using two integration times:

50µs for detecting short range objects and 2ms doing the same for the long range.

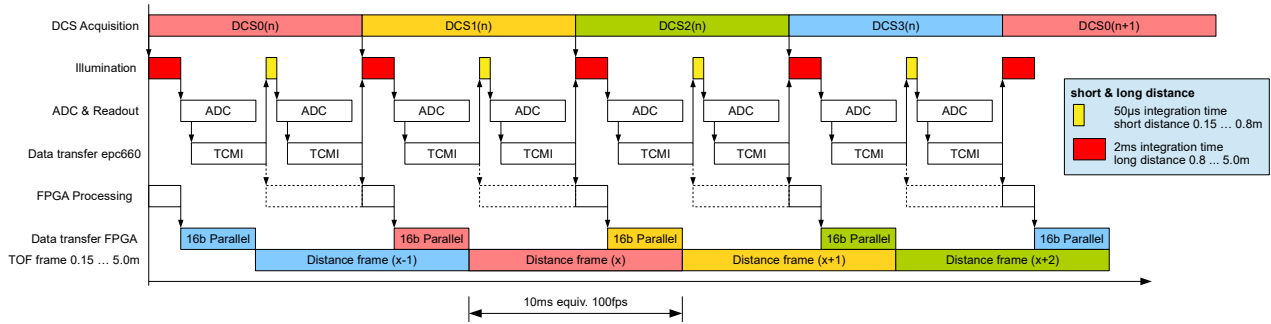

Figure 51: Enhanced rolling mode sequence with 2 integration times

Implementation example step by step: Rolling mode using 3 integration times

1. Chose single frame mode by setting register 0x22 and 0x92.
  2. Run 4 DCS turns by
  3. Select DCS0 and acquire 3 DCS0 each with one of the 3 integration times  
 Integration time t1 > shutter > readout > integration time t2 > shutter > readout > integration time t3 > shutter > readout.  
 2<sup>nd</sup> and following turns:  
 Calculate for each integration time the distance and TOF amplitude image with the last 4 corresponding DCS frames.  
 Select out of the acquired integration time distance images, already compensated, each time the most reliable distance information and compose the actual final distance picture.
  4. Select DCS1 and acquire 3 DCS1 each with one of the 3 integration times  
 Integration time t1 > shutter > readout > integration time t2 > shutter > readout > integration time t3 > shutter > readout  
 2<sup>nd</sup> and following turns:  
 Calculate for each integration time the distance and TOF amplitude image with the last 4 corresponding DCS frames.  
 Select out of the acquired integration time distance images, already compensated, each time the most reliable distance information and compose the actual final distance picture.
- ... and so on ...

	Register	0x22	0x25	0x92
Mode	DCS/Shutter	DCS select 1 <sup>st</sup> frame	DCS select 2 <sup>nd</sup> frame	Modulation select
4 DCS	DCS 0, 1, 2, 3	0x34	0x3D	0x30
2 DCS	DCS 0, 1	0x34	0x3D	0x10
	DCS 2, 3	0x32	0x33	
1 DCS rolling	DCS 0	0x34	Not used	0x00
	DCS 1	0x31		
	DCS 2	0x32		
	DCS 3	0x33		

Table 34: DCS selection for enhanced rolling mode

## 12. Parameter and configuration memory

### 12.1. Sequencer program

The sequencer program is the executable code of the chip's state-machine. ESPROS' intention is running always best chip performance by offering the user best suited sequencer program code in the download package of the evaluation kit. After each power-up, this program code must be downloaded by the application to the chip via the I<sup>2</sup>C interface. Refer to chapter 15.10.

#### IMPORTANT NOTICE:

Use always latest sequencer program which lists in its file header the corresponding chip type and version. Wrong sequencer programs will derate chip performance or even worse, lead to malfunction.

### 12.2. Data memory map

The epc635 control registers (RAM) are used for controlling all features of the chip. They are organized as 256x8 bit into 0x00 ... 0xFF address locations. The address space 0x80 ... 0xFF is EEPROM backed-up. EEPROM parameters in this section are stored permanently between the power off/on cycles. All registers can be accessed through I<sup>2</sup>C interface by the application CPU (see chapter 13. I2C interface). Multiple byte registers are stored in the order MSB first, then LSB.

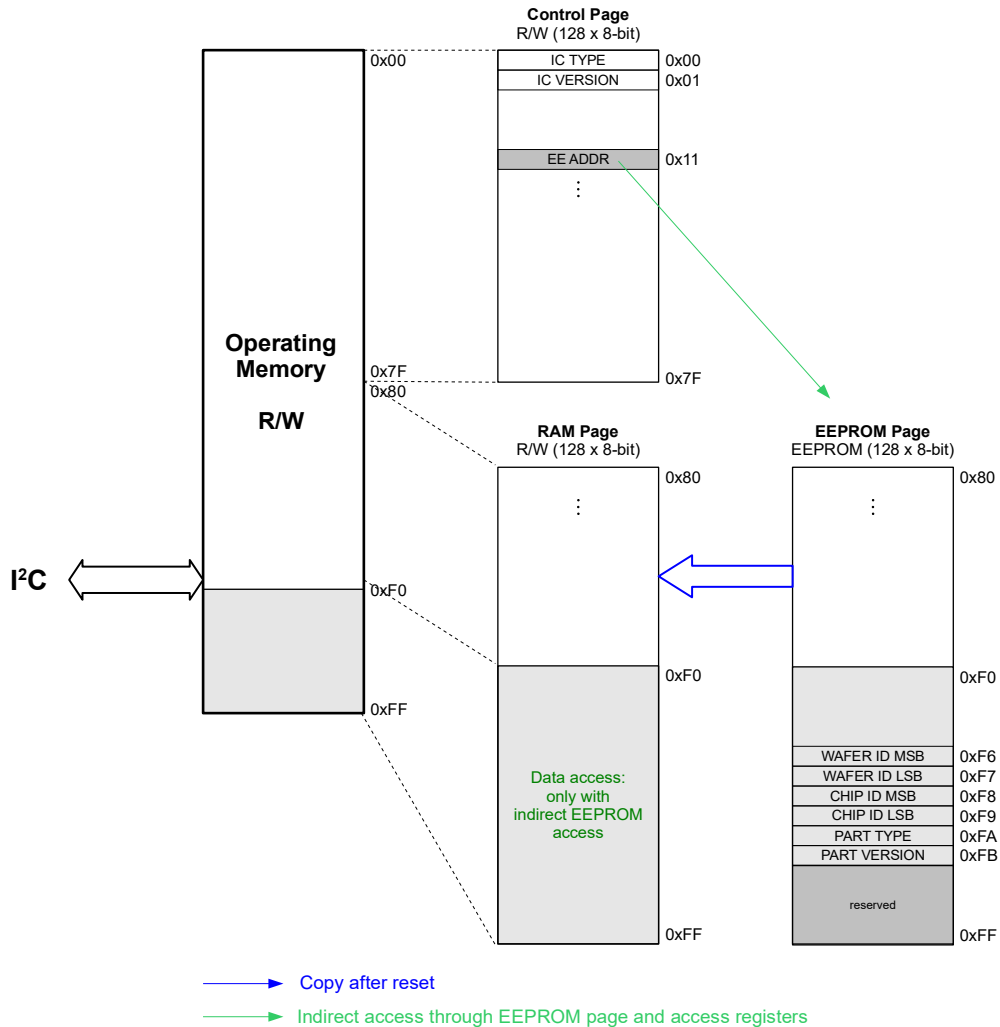

Figure 52: Memory map

#### 12.2.1. Control page

The control page contains R/W accessible registers with default values during startup. The content can be changed via the I<sup>2</sup>C interface. The changed values are preserved as long as the IC is powered. They are set back to their default values with a reset.

#### 12.2.2. RAM page

The RAM page contains R/W accessible registers with EEPROM copied values after startup. The content can be changed via the I<sup>2</sup>C interface. The changed values are preserved as long as the IC is powered. They are set back to EEPROM values with a reset.

#### 12.2.3. EEPROM page

The embedded 128x8-bit EEPROM stores operation parameters as well as factory set trimming and calibration values.

## 13. I<sup>2</sup>C interface

The I<sup>2</sup>C-bus interface allows accessing the R/W registers and the programming of the EEPROM registers which store the configuration parameters. It is the only interface through which the configuration registers can be accessed (52 and 37) by the application. It works as a slave device according to the I<sup>2</sup>C specification (refer to chapter 16.2.) with a transfer rate of up to 400 kbit/s in Fast Mode (FM) or 1Mbit/s in Fast Mode plus (FM+). The I<sup>2</sup>C master such as an external CPU can set the transfer speed simply by driving the SCL input at that frequency (up to 1MHz), therefore there is no prior register configuration or setting necessary.

I<sup>2</sup>C specification is supported in epc635 with following remarks/exceptions:

- 7-bit addressing only is supported
- Clock stretching is supported
- General call address: By transmitting 0x00 followed by 0x06 (issues software reset) or transmitting 0x00 followed by 0x04 (device address reload), the programmable part (A0, A1) of the I<sup>2</sup>C address pins is overwritten by the initially scanned value through strap pins during start-up or reset phase
- Software reset is supported
- Other uses of I<sup>2</sup>C bus are not supported.

### 13.1. Device addressing

The epc635 7-bit I<sup>2</sup>C device address is hard-wired to the value shown below in 53. Two address bits A0, A1 can be optionally initialized as 1 through strap pins (chapter 5.6.3.). In a typical single-camera 3D TOF imager application in which epc635 is directly connected as a single I<sup>2</sup>C slave to a single I<sup>2</sup>C master, the strap pins can be used without any external pull-up resistors. In this case, the device address is set after reset default as 010000. In a multi-camera application with up to 4 epc635 devices connected on the same I<sup>2</sup>C bus as slaves or together with other I<sup>2</sup>C slaves talking to a single I<sup>2</sup>C master, external pull-up resistors can be utilized on the strap pins to initialize different I<sup>2</sup>C device addresses in order to correctly identify different epc635 slaves on the bus.

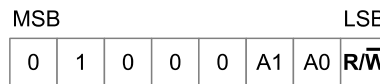

Figure 53: Device address through I<sup>2</sup>C

### 13.2. I<sup>2</sup>C bus protocol notation

The following notation is used:

- S      **S**TART condition
- P      **S**TOP condition
- A      **A**cknowledge last byte (ACK)
- $\bar{A}$     **N**ot-Acknowledge last byte (NACK)
- Shaded part of protocol: transmitted by master
- Unshaded part of protocol: transmitted by epc635

### 13.3. I<sup>2</sup>C bus timing

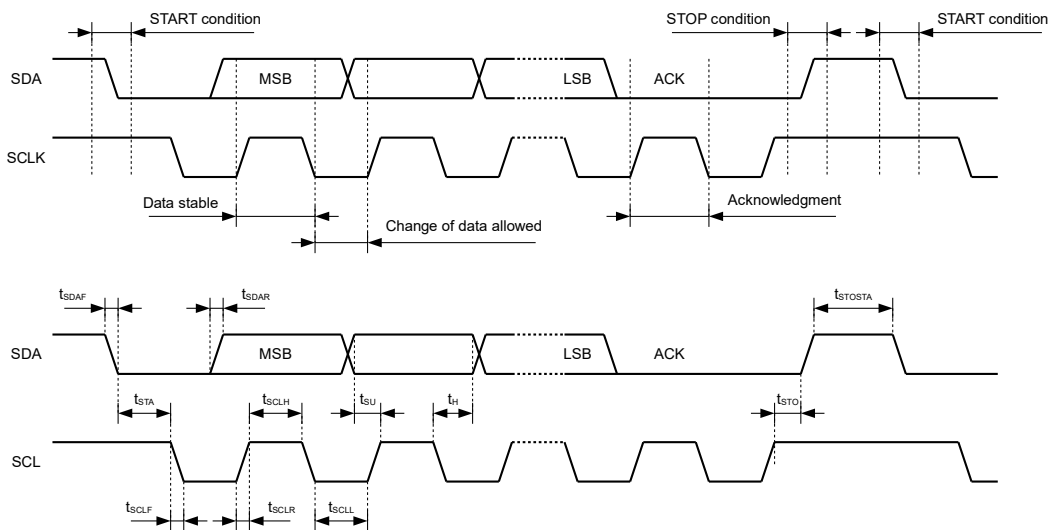

Figure 54: I<sup>2</sup>C bus timing

Symbol	Parameter	Min.	Max.	Units
t <sub>SCLL</sub>	SCL clock low time	0.5		μs
t <sub>SCLH</sub>	SCL clock high time	0.26		μs
t <sub>SU</sub>	SDA setup time	50		ns
t <sub>H</sub>	SDA hold time		0	ns
t <sub>SDAR</sub> / t <sub>SCLR</sub>	SDA and SCL rise time		120	ns
t <sub>SDAF</sub> / t <sub>SCLF</sub>	SDA and SCL fall time		120	ns
t <sub>STA</sub>	Start condition hold time	0.26		μs
t <sub>STO</sub>	Stop condition setup time	0.26		μs
t <sub>STOSTA</sub>	Stop to start condition time (bus free)	0.5		μs
C <sub>b</sub>	Capacitive load for each bus line		550	pF
t <sub>SP</sub>	Pulse width of the spikes which are filtered		50	ns

Table 35: I<sup>2</sup>C bus timing: Timing parameters (FM+)

### 13.4. I<sup>2</sup>C commands

#### 13.4.1. Software reset

(0x00, 0x06) issues a software reset, same behavior like hardware reset.

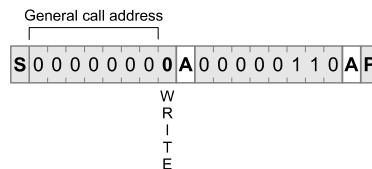

Figure 55: Software reset through I<sup>2</sup>C

#### 13.4.2. Device address reload

(0x00, 0x04) activates the I<sup>2</sup>C address stored in register 0xCA. Note that the values of A0 and A1 cannot be changed by software. Therefore, this general call command only works for bits 2 to 6 of register 0xCA (chapter 5.6.3).

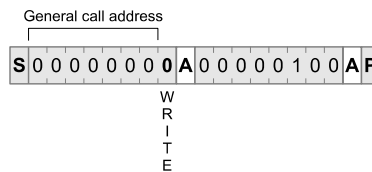

Figure 56: Device address A1, A0 reload through I<sup>2</sup>C

#### 13.4.3. Write single-byte

During a single-byte write, only one register is written. After the device address is transmitted, the master has to transmit the register address and the write data in two I<sup>2</sup>C data packets (57). The access is terminated by a STOP condition.

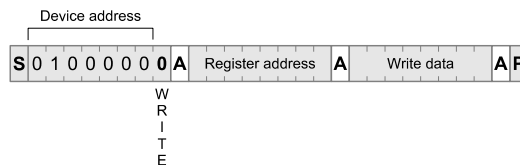

Figure 57: Single-byte Write access through I<sup>2</sup>C

#### 13.4.4. Write multi-byte

During a multi-byte write operation, the master transmits the device address and the address of the first register to be written. All subsequent bytes until the STOP condition are interpreted as write data packets (58). The write address pointer is incremented internally. Do not transmit more bytes that the write address pointer reaches the limit of the address space (see chapter 14., 37, 38).

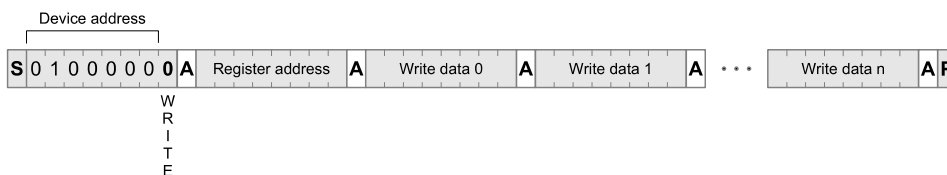

Figure 58: Multi-byte Write access through I<sup>2</sup>C



### 13.4.5. Read single-byte

The master transmits first the device address with a write command. Next, it writes the register address to be read. Then, the master transmits the device address again with a read command where the epc635 answers with the data stored in the addressed register. Finally, the master terminates the read sequence with a NACK and a STOP (59).

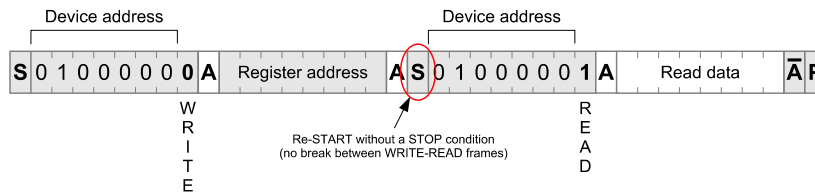

Figure 59: Single-byte Read access through I<sup>2</sup>C

### 13.4.6. Read multi-byte

The master transmits first the device address and the address of the first register to be read. After the epc635 is addressed with a read command, epc635 answers with read data bytes until the master does not acknowledge a byte. The master is expected to terminate the access with a STOP condition thereafter (60). During the access the read address pointer is incremented epc635 internally. Do not transmit more bytes that the write address pointer reaches the limit of the address space (see chapter 14., 37, 38).

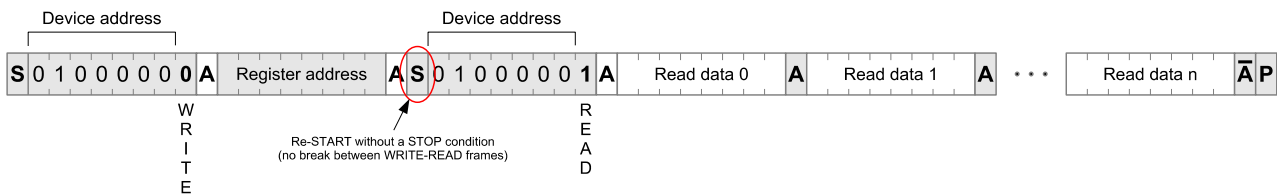

Figure 60: Multi-byte Read access through I<sup>2</sup>C

### 13.4.7. Command timing

The operating modes of the epc635 are initialized, activated, deactivated and monitored by sending several single or multi-byte write and read command sequences through I<sup>2</sup>C interface. This section lists and explains available commands together with their access time ( $f_{SCL} = 1\text{MHz} \rightarrow t_{SCL} = 1\mu\text{s}$ ).

There is no particular order defined for sending the commands. The only requirement is having no on-going frame acquisition process when updating non-shadowed registers. The registers marked with \*\* in the register map can be updated on-the-fly during a frame acquisition. New values are used by the next frame.

Command	Description	Length [Bytes]	Time [ $\mu\text{s}$ ]
Single-byte Write	Single-byte write to control registers	3	29
Multiple-byte Write	Multiple-byte write (n bytes) to control registers	2 + n	20 + n x 9
Single-byte Read	Single-byte read from control registers	4	39
Multiple-byte Read	Multiple-byte read (n bytes) from control registers	3 + n	30 + n x 9
Mode set	4, 2, or 1 DCS mode set using register 0x92	3	29
Integration time (short) set	Integration time set (up to 800 $\mu\text{s}$ ) using integration length 1 registers	4	38
Integration time (long) set	Integration time set using integration time multiplier and length 1 registers	6	56
Dual Integration time (long) set	Dual int. time set using integration time multiplier and length 1, 2 registers	8	74
Shutter	Start frame acquisition by using the shutter control register	3	29
Integration time (short) + Shutter	Integration time + soft shutter in one go! (Integration length 1 registers, shutter control register)	5	47
EEPROM Indirect Single Write	Indirect single write to EEPROM	9	20ms
EEPROM Indirect Single Read	Indirect single read from EEPROM	10	97

Table 36: I<sup>2</sup>C Control commands summary

## 14. Register map

Notes:

\*\* Shadow registers can be updated on-the-fly while a frame acquisition is going on. The new values are used at the start of the next frame.

Not listed registers are reserved and must not be altered by the user. Otherwise, chip malfunction can occur. However, if a register is accidentally overwritten, a RESET restores the factory settings.

The listed default values are after downloading the latest sequencer program to the chip.

### 14.1. Control page 0x00 ~ 0x7F

Addr.	Type	Default	Description																		
0x00	R	---	IC type for device family identification. For chip type refer to register 0xFA.																		
0x01	R	---	IC version for device mask identification. For chip version refer to register 0xFB.																		
0x11	R/W	---	Address register for indirect read/write access to EEPROM (refer to 15.5. and 15.6.)																		
0x12	R/W	---	Data register for indirect read/write access to EEPROM (refer to 15.5. and 15.6.)																		
0x1C	R/W	0x1E	TCMI ESM FS: frame start label (refer to 6.5)																		
0x1D	R/W	0xE1	TCMI ESM FE: frame end label (refer to 6.5)																		
0x1E	R/W	0xAA	TCMI ESM LS: line start label (refer to 6.5)																		
0x1F	R/W	0x55	TCMI ESM LE: line end label (refer to 6.5)																		
0x20	R	0x00	Strap scan register high (refer to 5.6.3): <table border="1" style="width: 100%; border-collapse: collapse;"> <thead> <tr> <th>Bit</th> <th>Function</th> <th>Default</th> </tr> </thead> <tbody> <tr> <td>0..4</td> <td>reserved</td> <td>0</td> </tr> <tr> <td>5</td> <td>Strap input 0: I<sup>2</sup>C address A0</td> <td>0</td> </tr> <tr> <td>6</td> <td>Strap input 1: I<sup>2</sup>C address A1</td> <td>0</td> </tr> <tr> <td>7</td> <td>reserved</td> <td>0</td> </tr> </tbody> </table> <p>Default start-up values of these registers are only valid until end of reset phase. Values might be overwritten by external pull-up resistors during strap scan phase when reset is released.</p>	Bit	Function	Default	0..4	reserved	0	5	Strap input 0: I <sup>2</sup> C address A0	0	6	Strap input 1: I <sup>2</sup> C address A1	0	7	reserved	0			
Bit	Function	Default																			
0..4	reserved	0																			
5	Strap input 0: I <sup>2</sup> C address A0	0																			
6	Strap input 1: I <sup>2</sup> C address A1	0																			
7	reserved	0																			
0x22	R/W	0x30	DCS selection for 1 <sup>st</sup> frame (refer to the chapter 11.8): <table border="1" style="width: 100%; border-collapse: collapse;"> <thead> <tr> <th>Bit</th> <th>Function</th> <th>Default</th> </tr> </thead> <tbody> <tr> <td>0</td> <td>mgx0 modulator (mga0, mgb0)</td> <td>0</td> </tr> <tr> <td>1</td> <td>00: DCS 0 01: DCS 1 10: DCS 2 11: DCS 3</td> <td>0</td> </tr> <tr> <td>2</td> <td>mgx1 modulator (mga1, mgb1)</td> <td>0</td> </tr> <tr> <td>3</td> <td>00: DCS 0 01: DCS 1 10: DCS 2 11: DCS 3</td> <td>0</td> </tr> <tr> <td>4..7</td> <td>reserved</td> <td>0x3</td> </tr> </tbody> </table>	Bit	Function	Default	0	mgx0 modulator (mga0, mgb0)	0	1	00: DCS 0 01: DCS 1 10: DCS 2 11: DCS 3	0	2	mgx1 modulator (mga1, mgb1)	0	3	00: DCS 0 01: DCS 1 10: DCS 2 11: DCS 3	0	4..7	reserved	0x3
Bit	Function	Default																			
0	mgx0 modulator (mga0, mgb0)	0																			
1	00: DCS 0 01: DCS 1 10: DCS 2 11: DCS 3	0																			
2	mgx1 modulator (mga1, mgb1)	0																			
3	00: DCS 0 01: DCS 1 10: DCS 2 11: DCS 3	0																			
4..7	reserved	0x3																			
0x25	R/W	0x35	DCS selection for 2 <sup>nd</sup> frame (refer to the chapter 11.8): <table border="1" style="width: 100%; border-collapse: collapse;"> <thead> <tr> <th>Bit</th> <th>Function</th> <th>Default</th> </tr> </thead> <tbody> <tr> <td>0</td> <td>mgx0 modulator (mga0, mgb0)</td> <td>1</td> </tr> <tr> <td>1</td> <td>00: DCS 0 01: DCS 1 10: DCS 2 11: DCS 3</td> <td>0</td> </tr> <tr> <td>2</td> <td>mgx1 modulator (mga1, mgb1)</td> <td>1</td> </tr> <tr> <td>3</td> <td>00: DCS 0 01: DCS 1 10: DCS 2 11: DCS 3</td> <td>0</td> </tr> <tr> <td>4..7</td> <td>reserved</td> <td>0x3</td> </tr> </tbody> </table>	Bit	Function	Default	0	mgx0 modulator (mga0, mgb0)	1	1	00: DCS 0 01: DCS 1 10: DCS 2 11: DCS 3	0	2	mgx1 modulator (mga1, mgb1)	1	3	00: DCS 0 01: DCS 1 10: DCS 2 11: DCS 3	0	4..7	reserved	0x3
Bit	Function	Default																			
0	mgx0 modulator (mga0, mgb0)	1																			
1	00: DCS 0 01: DCS 1 10: DCS 2 11: DCS 3	0																			
2	mgx1 modulator (mga1, mgb1)	1																			
3	00: DCS 0 01: DCS 1 10: DCS 2 11: DCS 3	0																			
4..7	reserved	0x3																			

Table 37: Address map of the control page (0x00 ~ 0x7F)

Addr.	Type	Default	Description		
0x3A	R/W	0x00	Readout mode for grayscale 0x10: single-ended readout (negative numbers are clipped) 0x00: differential readout. Select this mode by the user application, refer to chapter 9.3 and 10.1		
0x3C	R/W	0x26	Modulation control in grayscale mode:		
			<b>Bit</b>	<b>Function</b>	<b>Default</b>
			0	reserved	0
			1..2	reserved	1
			3	reserved	0
			4	0: LED/LD modulated 1: LED/LD on during integration	0
			5	0: LED/LD modulated 1: LED/LD off during integration	1
6..7	reserved	0			
0x60	R	---	Temperature sensor, refer to chapter 10		
0x61	R	---			
0x71	R/W	0x00	Number of fine DLL delay steps to delay the LED output by approx. 10ps per step. Valid only if bit 2 in register 0xAE is enabled. Refer also to register 0xAE and chapter 5.8. Max. value is 799 (0x31F). Note: Delay is sensitive to VDD variations and noise.		
0x72	R/W	0x00			
0x73	R/W	0x00	Number of coarse DLL delay steps to delay the LED output by approx. 2ns per step. Valid only if bit 2 in register 0xAE is enabled. Refer also to register 0xAE and chapter 5.8. Max. value is 49 (0x31). Note: Delay is sensitive to VDD variations and noise.		
0x7D	R/W	0x04	Mode control:		
			<b>Bit</b>	<b>Function</b>	<b>Default</b>
			0..1	reserved	0
			2	Enable PLL 0: disable 1: enable	1
3..7	reserved	0			

Cont. 37: Address map of the control page (0x00 ~ 0x7F)

14.2. RAM page (0x80 ~ 0xEF)

Addr.	Type	Default	Description		
0x80	R/W	0x3F	Clock control:		
			<b>Bit</b>	<b>Function</b>	<b>Default</b>
			0..5	reserved	1
			6	Modulation clock source 0: Internal modulation clock 1: External clock from MODCLK input	0
			7	reserved	0
0x85	R/W	0x01	Modulation clock divider:		
			<b>Bit</b>	<b>Function</b>	<b>Default</b>
			0	Modulation clock divider provides clock to the LED/Pixel-field modulator/demodulator circuits by integer division of the internal PLL clock or external MODCLK:	1
			1		0
			2		0
			3	$f_{\text{mod\_clk}} = 80\text{MHz} / (\text{modulation clock divider} + 1)$ Default: $80\text{MHz} / (0x01 + 0x01)$ : $f_{\text{mod\_clk}} = 40\text{MHz}$	0
4	Maximal value of modulation clock divider = $0x1F$ : $f_{\text{mod\_clk}} = 2.5\text{MHz}$ Note: The LED modulation frequency is 4 times lower than $f_{\text{mod\_clk}}$	0			
			5..7	reserved	0
0x89	R/W	0x03	TCMI clock control:		
			<b>Bit</b>	<b>Function</b>	<b>Default</b>
			0		1
			1	TCMI clock divider:	1
			2	$f_{\text{tcml\_clk}} = 80\text{MHz} / (\text{TCMI clock divider} + 1)$ Default: $80\text{MHz} / (0x03 + 0x01) = 20\text{MHz}$	0
			3	Maximal value of TCMI clock divider = $0x1F = 2.5\text{MHz}$	0
			4		0
			5..6	reserved	0
			7	DCLK skew enable: 0: disable 1: enable Used to delay DCLK edge (typ. 2ns) to compensate PCB delays. Might be particularly useful when TCMI clock divider = 0 (divided by 1). When set normal, DCLK edge is centred with respect to other TCMI *SYNC*, DATA[7:0] outputs.	0
0x8B	R/W	0x01	Number of PLL clock periods delay of the demodulation signal path (all modulation modes). It can be used to insert a phase shift between modulation (LED) and demodulation (pixel). 1 PLL clock cycle is 12.5ns @ 80MHz PLL clock. This is equivalent to a distance shift of 1.875m independent of the LED modulation frequency. Note: This phase shift is temperature independent. 0: no delay 1: 1 clock 2: 2 clocks ... 12: 12 clocks (max. value)		

Table 38: Address map of the RAM page (0x80 ~ 0xEF)

Addr.	Type	Default	Description		
0x90	R/W	0xC4	LED driver control:		
			<b>Bit</b>	<b>Function</b>	<b>Default</b>
			0	reserved	0
			1	Inverts output signals LED and LED2 if drivers are enabled 0: not inverted, e.g. LED = 0, not active: Pin LED non-conductive, LED2 = VSSIO. 1: inverted, e.g. LED = 0, not active: Pin LED conductive, LED2 = VDDIO.	0
			2	LED output select: 0: LED driver is disable. Pin LED is non-conductive. 1: LED driver is enabled.	1
			3	reserved	0
			4	LED/LD permanently on (torch function, no modulation) if drivers are enabled: 0: off 1: on (Refer to IMPORTANT NOTE chapter 5.7)	0
			5	LED2 output select: 0: LED2 driver disabled. Output is in Tri-State with termination resistor to VSSIO. 1: LED2 driver enabled.	0
6..7	reserved	1			
0x91	R/W	0x03	Sequencer control:		
			<b>Bit</b>	<b>Function</b>	<b>Default</b>
			0..1	reserved	1
			3..5	reserved	0
			6	If enabled, avoids readout rollover when using slower DCLKs e.g. DCLK < 10MHz. Stretches HSYNC for slower TCMI interface. Causes reduced DCS frame rate due to additional 2µs per ADC conversion ( $t_{conv}/2 + 2\mu s$ ). 0: disable for DCLK > 10MHz (default) 1: enable for DCLK = 10MHz or lower	0
7	reserved	0			
0x92**	R/W	0x34	Modulation select:		
			<b>Bit</b>	<b>Function</b>	<b>Default</b>
			0..1	reserved	0
			2	reserved	1
			3	Dual integration time mode – acquisition with 2 integration times per DCS frame using additionally integration length 2 registers 0x9E and 0x9F: 0: disable 1: enable Needs register 0x94 set to 0x80, otherwise it is not effective (see 39)	0
			4	Number of DCS readouts select: 00: Grayscale mode, DCS0 only	1
			5	01: Dual phase mode, DCS0, DCS1 or DCS2,DCS3 10: reserved 11: Full resolution mode or dual int. mode, DCS0, DCS1, DCS2, DCS3	1
			6	Modulation select: 00: TOF mode	0
7	01: reserved 10: reserved 11: Grayscale mode	0			
0x94**	R/W	0x00	Pixel operating and readout control. Refer to chapter 8.2 and 11.5: 0x00: Default, TOF mode: full resolution mode 0x80: Dual phase or dual integration time mode		

Cont. 38: Address map of the RAM page (0x80 ~ 0xEF)

Addr.	Type	Default	Description			
0x9D**	R/W	0x50	ADC resolution control, refer to chapter 8.4: 0x50: 12 bit resolution 0x34: 8 bit resolution			
0x9E**	R/W	0x07	Integration length 2: Number of modulation clock periods for the second integration time in the dual integration time mode (refer to 8.2.3, default: 2'047). See registers 0xA2 and 0xA3 for functional definition details. Bit 3 in register 0x92 has to be set to 1 to enable this integration time for the even rows. The odd rows operate with the integration length 1 set in registers 0xA2 and 0xA3.			
0x9F**	R/W	0xFF				
0xA0**	R/W	0x00	Integration time multiplier (10 bit value) for integration lengths set with the integration length registers (default = 1, min. value = 1). This multiplier is active on both settings integration length 1 and 2.			
0xA1**	R/W	0x01				
0xA2**	R/W	0x07	Integration length 1: Number of modulation clock periods for the (first in the dual integration time mode) integration time (16 bit value, default = 2'047, min. value = 7 which is integration time 200ns @ 10MHz). Integration time = Integration time multiplier * (Integration length + 1) * t <sub>mod_clk</sub> e.g. for defaults @ 10MHz modulation clock = 51.2µs Note: (Integration length + 1) should be evenly divisible by 4.			
0xA3**	R/W	0xFF				
0xA4	R/W	0x00	Shutter Control:			
			<b>Bit</b>	<b>Function</b>	<b>Default</b>	
			0	Shutter release. Refer to chapter 6.2 0: disable 1: enable. In single shot mode: Starts acquisition and is auto cleared. Note: Shutter release is not auto-cleared when multiple frames is enable.	0	
			1	Multiple frames (auto-run or video mode). Refer to chapter 6.2 0: disable. Single shot mode. 1: enable. Multiple frame mode active if shutter enabled. Refer to chapter 6.2.2.	0	
			2..7	reserved	0	
0xA5	R/W	0x07	Power control (Refer also to 11.6.) 0x00: Power off 0x07: Power on			
0xAE	R/W	0x01	DLL control (Refer also to register 0x73 and chapter 5.8): 0x01: no delay 0x04: delay manually set by register 0x73 Note: The change of register 0xAE from 0x01 to 0x04 generates also a delay, even if register 0x73 is set to 0x00.			
0xCA	R	0x20	<b>Bit</b>	<b>Function</b>	<b>Default</b>	
			0	I <sup>2</sup> C device address A6 ... A2 of 7-bit I <sup>2</sup> C device address. Programmable via direct access from I <sup>2</sup> C or from EEPROM during start up, followed by an I <sup>2</sup> C general call "Device address reload" to take it into effect.	0	
			1		reserved, I <sup>2</sup> C address A1, A0 of 7-bit I <sup>2</sup> C device address. Programmable only during reset via strap pins using external pull-up resistors.	0
			2		0	
			3		0	
			4		0	
			5		1	
			6		0	
7	reserved	0				

Cont. 38: Address map of the RAM page (0x80 ~ 0xEF)

Addr.	Type	Default	Description		
0xCB	R/W	0x23	I <sup>2</sup> C and TCMi control:		
			<b>Bit</b>	<b>Function</b>	<b>Default</b>
			0	I <sup>2</sup> C clock stretching 0: disabled 1: enabled	1
			1	I <sup>2</sup> C pins input spike filter 0: disabled (> 1MHz) 1: enabled (≤ 1MHz, FM+) When I <sup>2</sup> C pins input spike filter = 0, SDA and SCL pins can be used up to 10MHz as inputs (driven rail-to-rail by a real CMOS driver, no pull-up) and up to 2MHz as outputs.	1
			2	TCMI ESM mode enable (refer to 6.5) 0: disabled 1: enabled	0
			3	TCMI DCLK mode select (refer also to 6.1.) 0: continuous 1: gated	0
			4	TCMI data format (refer also to 6.4). 01: 8 bit mode. Transfers the 8 MSB bits of the pixel data with 1x DCLK. 10: lsb/msb split mode: Transfers 12 bit pixel data with LSB byte leading and MS-Byte trailing with 2x DCLK. Data are MSB aligned (default). The optional SAT bit is on the LSB. 11: msb/lsb split mode: Transfers 12 bit pixel data with MSByte leading and LS-Byte trailing with 2x DCLK. Data are MSB aligned. The optional SAT bit is on the LSB.	0
			5		1
			6	When split modes selected (= 11 or 10), forces bit DATA[0] of the LSB byte = 1 when the pixel is saturated. Not effective with other TCMI data formats. 0: disabled 1: enabled	0
7	reserved	0			
0xCC	R/W	0x00	TCMI polarity settings:		
			<b>Bit</b>	<b>Function</b>	<b>Default</b>
			0	DCLK edge select to align all other TCMI outputs 0: falling edge 1: rising edge	0
			1	HSYNC polarity 0: HSYNC active low 1: HSYNC active high	0
			2	VSYNC polarity 0: VSYNC active low 1: VSYNC active high	0
			3	XSYNC polarity 0: XSYNC active low 1: XSYNC active high Only effective when bit 6 is set to 0	0
			4	DATA[11:0] unsigned/signed TCMI data output format 0: unsigned integer, subtract 2 <sup>048</sup> to get correct value (Default) 1: two's complement signed integer (-2 <sup>048</sup> ... 2 <sup>047</sup> ).	0
			5	reserved	0
			7	Force DATA[11:0] = 0xFFF (unsigned) / 0x7FF (signed, two's complement) during data-out operation when corresponding pixel is saturated 0: disabled 1: enabled	0

Cont. 38: Address map of the RAM page (0x80 ~ 0xEF)

Addr.	Type	Default	Description
0xCD	R/W	0x13	ADC control, refer to chapter 8.4: 0x13: 12 bit resolution 0x1B: 8 bit resolution Registers 0x9D must be set according chapter 8.4
0xE8	R/W	---	Temperature offset correction for the calculation according the formula in chapter 10 by the application SW. Range approx. -27 ... +27°C with around 0.2°C steps. The reference temperature is +27°C. 0x7F (127) corresponds to 0°C offset. 0xFF: Function is not supported.
0xE9	R/W	---	DLL step. Supported for Wafer IDs 40 or higher. Refer for details to register 0x73 and 21. The exact value is $t_{DLL} = ((\text{register } 0xE9 - 128) * 0.003\text{ns}) + 2.1\text{ns}$ (at +27°C, $V_{DD}, V_{DDPLL} = 1.8\text{V}$ ). 0xFF: Function is not supported.

Cont. 38: Address map of the RAM page (0x80 ~ 0xEF)

### 14.3. EEPROM page, indirect data access section (0xF0 ~ 0xFF)

Addr.	Type	Default	Description
0xF0	R/W	0x00	User register for user data. Do not write the register during frame acquisition. The number of WRITE cycles into the EEPROM should not exceed 100 WRITE operations.
0xF5	R	0x00	Customer ID
0xF6	R	---	Wafer ID
0xF7	R	---	
0xF8	R	---	
0xF9	R	---	Chip ID
0xFA	R	0x04	Chip and part type: 0x04 = epc635
0xFB	R	---	Chip and part version (release) e.g. 0x01 for version -001

Table 39: Address map of the EEPROM page (0xF0 ~ 0xFF)

## 15. Control command examples

To simplify command sequence definitions, following C-programming language style functions are defined for the I<sup>2</sup>C master CPU:

- `i2cGeneralCall(byte genAdr, byte cmd);` //  $20 \times t_{SCL} = 20\mu\text{s}$
- `i2cSingleWrite(byte devAdr, byte regAdr, byte regVal);` //  $29 \times t_{SCL} = 29\mu\text{s}$
- `i2cMultiWrite(byte devAdr, byte regAdr, byte* regVal, byte n` //  $20 + (n \times 9 \times t_{SCL}) = 20 + (n \times 9)\mu\text{s}$
- `byte i2cSingleRead(byte devAdr, byte regAdr);` //  $39 \times t_{SCL} = 39\mu\text{s}$
- `byte* i2cMultiRead(byte devAdr, byte regAdr, byte n);` //  $30 + (n \times 9 \times t_{SCL}) = 30 + (n \times 9)\mu\text{s}$

### 15.1. Software reset

PRECONDITION: None

1. `i2cGeneralCall(0x00, 0x06);` // Software reset, same effect like  $\overline{\text{RESET}}$  pin,  $20\mu\text{s}$
2. ... // Wait for  $t_{\text{RESET}} (> 100\text{ns})$

### 15.2. 4 DCS: Acquire DCS0 ... 3 frames with $t_{\text{int}} = 20\mu\text{s}$ @ 10MHz modulation frequency

PRECONDITION: All other registers contain default values.

1. `i2cSingleWrite(0x20, 0x92, 0x34);` // Modulation control 0x92 = 0x34 (mod. sel. = 00, No. DCS = 11),  $29\mu\text{s}$
2. `i2cMultiWrite(0x20, 0xA2, &(0x031F), 2);` // Integration length 1 0xA2/0xA3 = 0x031F (integration time =  $20\mu\text{s}$ ),  $38\mu\text{s}$
3. `i2cSingleWrite(0x20, 0xA4, 0x01);` // Shutter control 0xA4 = 0x01, (shutter release = 1),  $29\mu\text{s}$
4. ... // Acquisition starts. Wait until all 4x DCS frames are finished.

### 15.3. 4 DCS: Acquire DCS0 ... 3 frames with $t_{\text{int}} = 20\mu\text{s}$ , followed by DCS 0 ... 3 with $t_{\text{int}} 400\mu\text{s}$ @ 10MHz mod. frequency

PRECONDITION: All other registers contain default values.

1. `i2cSingleWrite(0x20, 0x92, 0x34);` // Modulation control 0x92 = 0x34 (mod. sel. = 00, No. DCS = 11),  $29\mu\text{s}$
2. `i2cMultiWrite(0x20, 0xA2, &(0x031F), 2);` // Integration length 1 0xA2/0xA3 = 0x031F (integration time =  $20\mu\text{s}$ ),  $38\mu\text{s}$
3. `i2cSingleWrite(0x20, 0xA4, 0x01);` // Shutter control 0xA4 = 0x01, (shutter release = 1),  $29\mu\text{s}$
4. ... // Acquisition starts. Wait until all 4x DCS frames are finished.
5. `i2cMultiWrite(0x20, 0xA2, &(0x3E7F), 2);` // Integration length 1 0xA2/0xA3 = 0x3E7F (integration time =  $400\mu\text{s}$ ),  $38\mu\text{s}$
6. `i2cSingleWrite(0x20, 0xA4, 0x01);` // Shutter control 0xA4 = 0x01, (shutter release = 1),  $29\mu\text{s}$
7. ... // Acquisition starts. Wait until all 4x DCS frames are finished.



#### 15.4. 2 DCS: Acquire DCS0 and 1 frames with $t_{int} = 20\mu s$ @ 10MHz modulation frequency

PRECONDITION: All other registers contain default values.

1. `i2cSingleWrite(0x20, 0x92, 0x14);` // Modulation control `0x92 = 0x34` (mod. sel. = 00, No. DCS = 11), 29 $\mu s$
2. `i2cMultiWrite(0x20, 0xA2, &(0x031F), 2);` // Integration length 1 `0xA2/0xA3 = 0x031F` (integration time = 20 $\mu s$ ), 38 $\mu s$
3. `i2cSingleWrite(0x20, 0xA4, 0x01);` // Shutter control `0xA4 = 0x01`, (shutter release = 1), 29 $\mu s$
4. ... // Acquisition starts. Wait until all 2x DCS frames are finished.

#### 15.5. Indirect single write to EEPROM: Store 1 byte at user register 0xF0

PRECONDITION: None

1. `i2cSingleWrite(0x20, 0x11, 0xF0);` // EEPROM address register `0x11 = 0xF0`, 29 $\mu s$
2. `i2cSingleWrite(0x20, 0x12, 0x22);` // EEPROM data register `0x12 = 0x22`  
// (user register 1 = 0x22), 29 $\mu s$  + 20ms = ~20ms
3. ...

Note 1: Start address is written in address register 0x11 for indirect read/write access to the EEPROM.

Note 2: Each EEPROM data register write starts erase/programming EEPROM. Each EEPROM write takes 20ms.

Note 3: Corresponding control register value is not modified. Only EEPROM register is modified.

Note 4: EEPROM content will only be copied to corresponding control register after RESET.

#### 15.6. Indirect single read from EEPROM: Read 1 byte from user register 0xF0

PRECONDITION: None

1. `i2cSingleWrite(0x20, 0x11, 0xF0);` // EEPROM address register `0x11 = 0xF0`, 29 $\mu s$
2. `cal1 = i2cSingleRead(0x20, 0x12);` // user value 1 = EEPROM data register (user register 1 0xF0), 39 $\mu s$
3. ...

Note 1: Start address is written in the EEPROM address register 0x11.

Note 2: Corresponding control register value is not modified. Only EEPROM is read.

#### 15.7. Reading part version (register 0xFB)

Since there is no RAM register at address 0xFB, the PART VERSION can only be read directly from the EEPROM.

```
# The syntax of the I2C commands is as follows:
# Reading: i2c r REGISTER_ADDRESS [NUMBER_OF_BYTES]
# Writing: i2c w REGISTER_ADDRESS [DATA1 DATA2 ...]

i2c w 11 FB
i2c r 12 01 # Response: PART VERSION
```

#### 15.8. Reading IC version (register 0x01)

I2C command to read IC version

```
# The syntax of the I2C commands is as follows:
# Reading: i2c r REGISTER_ADDRESS [NUMBER_OF_BYTES]
# Writing: i2c w REGISTER_ADDRESS [DATA1 DATA2 ...]

i2c r 01 01 # Response: IC VERSION
```

#### 15.9. Reading WAFER ID and CHIP ID

It can be necessary for technical support to read the WAFER ID and the CHIP ID. Since there are no RAM register at addresses 0xF6 to 0xF9, the WAFER ID and the CHIP ID can only be read directly from the EEPROM.

```
# The syntax of the I2C commands is as follows:
# Reading: i2c r REGISTER_ADDRESS [NUMBER_OF_BYTES]
# Writing: i2c w REGISTER_ADDRESS [DATA1 DATA2 ...]

i2c w 11 F6
i2c r 12 01 # Response: WAFER ID MSB
i2c r 12 01 # Response: WAFER ID LSB
i2c r 12 01 # Response: CHIP ID MSB
i2c r 12 01 # Response: CHIP ID LSB
```

#### 15.10. Pixel sequencer code write procedure

1. Startup epc660 chip (power up or reset release).
2. Wait until the chip is in READY state.
3. Write the pixel sequencer code from chapter 15.11. to the memory.

### Important Notes:

This procedure has to be executed after every power up or after a chip reset release (refer also to chapter Fehler: Verweis nicht gefunden).

Never modify this code sequence. Otherwise malfunction occurs.

### 15.11. Pixel sequencer code

```
# Pixel Sequencer Code V11
# The following sequence of I2C commands re-program the sequencer to be on most actual functionality.
#
# The syntax of the I2C commands to the imager is as follows:
# Writing: i2c w REGISTER_ADDRESS [RAM_ADDRESS DATA0 DATA1 DATA2 DATA3 DATA4 DATA5 SR_PROGRAM]

i2c w a4 00
i2c w 91 00
i2c w 47 01
i2c w 40 00 43 10 00 C0 00 00 0D
i2c w 40 01 43 10 00 00 01 00 0D
i2c w 40 02 43 10 00 40 0A 00 0D
i2c w 40 03 43 10 10 02 58 00 0D
i2c w 40 04 43 10 20 01 80 00 0D
i2c w 40 05 43 10 F0 01 B0 00 0D
i2c w 40 06 43 10 00 01 60 00 0D
i2c w 40 07 43 10 C0 00 78 00 0D
i2c w 40 08 43 00 40 00 18 00 0D
i2c w 40 09 43 00 D0 02 40 00 0D
i2c w 40 0A 43 00 10 C0 1E 00 0D
i2c w 40 0B 43 10 00 00 50 00 0D
i2c w 40 0C 43 00 20 00 18 00 0D
i2c w 40 0D 43 00 D0 02 40 00 0D
i2c w 40 0E 43 00 10 C0 1E 00 0D
i2c w 40 0F 43 10 00 00 50 00 0D
i2c w 40 10 43 00 D0 02 40 00 0D
i2c w 40 11 43 10 00 00 50 00 0D
i2c w 40 12 43 08 40 40 02 00 0D
i2c w 40 13 43 08 02 00 00 00 0D
i2c w 40 14 43 08 00 00 A8 00 0D
i2c w 40 15 43 18 80 07 0C 00 0D
i2c w 40 16 43 08 00 00 00 00 0D
i2c w 40 17 43 08 01 00 00 00 0D
i2c w 40 18 43 08 00 00 A8 00 0D
i2c w 40 19 03 08 30 03 40 00 0D
i2c w 40 1A 03 08 E0 01 60 00 0D
i2c w 40 1B 03 08 10 C0 02 00 0D
i2c w 40 1C 03 08 30 03 40 00 0D
i2c w 40 1D 03 00 00 00 00 00 0D
i2c w 40 1E 03 00 00 00 50 00 0D
i2c w 40 1F 43 10 80 40 02 00 0D
i2c w 40 20 43 10 60 00 50 00 0D
i2c w 40 21 43 18 60 40 02 00 0D
i2c w 40 22 43 18 90 07 0C 00 0D
i2c w 40 23 43 08 01 00 00 00 0D
i2c w 40 24 43 08 00 00 A8 00 0D
i2c w 40 25 03 08 30 03 40 00 0D
i2c w 40 26 03 00 88 00 10 00 0D
i2c w 40 27 03 00 88 3E 0C 00 0D
i2c w 40 28 03 00 08 00 14 00 0D
i2c w 40 29 03 00 80 00 10 00 0D
i2c w 40 2A 03 00 80 3E 0C 00 0D
i2c w 40 2B 03 00 00 00 14 00 0D
i2c w 40 2C 03 00 00 00 50 00 0D
i2c w 40 2D 43 08 02 00 00 00 0D
i2c w 40 2E 43 08 00 00 A8 00 0D
i2c w 40 2F 43 18 00 00 00 00 0D
i2c w 40 30 43 08 01 00 3C 00 0D
i2c w 40 31 43 08 00 00 A8 00 0D
i2c w 40 32 43 08 00 00 14 00 0D
i2c w 40 33 43 08 00 C0 00 00 0D
i2c w 40 34 43 08 00 00 01 00 0D
i2c w 40 35 43 88 00 00 00 00 0D
i2c w 40 36 43 08 30 0A 0C 00 0D
i2c w 40 37 43 28 00 00 00 00 0D
i2c w 40 38 43 08 40 00 0C 00 0D
i2c w 40 39 43 08 C0 03 88 00 0D
i2c w 40 3A 43 08 60 09 48 00 0D
i2c w 40 3B 40 08 00 00 44 00 0D
i2c w 40 3C 43 08 F0 03 8C 00 0D
i2c w 40 3D 43 08 50 08 48 00 0D
i2c w 40 3E 40 08 00 00 44 00 0D
```

i2c w 40 3F 43 08 20 04 90 00 0D  
i2c w 40 40 41 08 60 07 48 00 0D  
i2c w 40 41 40 08 00 00 44 00 0D  
i2c w 40 42 41 08 40 04 48 00 0D  
i2c w 40 43 40 08 00 00 44 00 0D  
i2c w 40 44 05 08 00 00 34 00 0D  
i2c w 40 45 04 08 50 00 0C 00 0D  
i2c w 40 46 84 0A F0 00 0C 00 0D  
i2c w 40 47 84 0F 00 00 54 00 0D  
i2c w 40 48 85 0E 10 00 0C 00 0D  
i2c w 40 49 01 0E D0 00 0C 00 0D  
i2c w 40 4A 00 0E 00 00 AC 00 0D  
i2c w 40 4B 40 2E 00 00 00 00 0D  
i2c w 40 4C 40 08 80 05 9C 00 0D  
i2c w 40 4D 40 08 60 00 0C 00 0D  
i2c w 40 4E 41 08 00 00 00 00 0D  
i2c w 40 4F 09 48 00 00 00 00 0D  
i2c w 40 50 08 08 50 00 0C 00 0D  
i2c w 40 51 88 0A F0 00 0C 00 0D  
i2c w 40 52 88 0F 00 00 54 00 0D  
i2c w 40 53 89 0E 10 00 0C 00 0D  
i2c w 40 54 01 0E D0 00 0C 00 0D  
i2c w 40 55 00 0E 00 00 AC 00 0D  
i2c w 40 56 40 2E 00 00 00 00 0D  
i2c w 40 57 40 08 F0 06 94 00 0D  
i2c w 40 58 40 08 F0 06 94 00 0D  
i2c w 40 59 40 08 50 00 0C 00 0D  
i2c w 40 5A 41 08 00 00 00 00 0D  
i2c w 40 5B 11 48 00 00 00 00 0D  
i2c w 40 5C 10 08 50 00 0C 00 0D  
i2c w 40 5D 90 0A F0 00 0C 00 0D  
i2c w 40 5E 90 0F 00 00 54 00 0D  
i2c w 40 5F 91 0E 10 00 0C 00 0D  
i2c w 40 60 01 0E D0 00 0C 00 0D  
i2c w 40 61 00 0E 00 00 AC 00 0D  
i2c w 40 62 40 2E 00 00 00 00 0D  
i2c w 40 63 40 08 F0 06 9C 00 0D  
i2c w 40 64 40 08 60 00 0C 00 0D  
i2c w 40 65 41 08 00 00 00 00 0D  
i2c w 40 66 21 48 00 00 00 00 0D  
i2c w 40 67 20 08 50 00 0C 00 0D  
i2c w 40 68 A0 0A F0 00 0C 00 0D  
i2c w 40 69 A0 0F 00 00 54 00 0D  
i2c w 40 6A A1 0E 10 00 0C 00 0D  
i2c w 40 6B 01 0E D0 00 0C 00 0D  
i2c w 40 6C 00 0E 00 00 AC 00 0D  
i2c w 40 6D 40 2E 00 00 00 00 0D  
i2c w 40 6E 40 08 00 00 00 00 0D  
i2c w 40 6F 40 08 00 C0 03 00 0D  
i2c w 40 70 40 08 50 00 0C 00 0D  
i2c w 40 71 41 48 00 00 14 00 0D  
i2c w 40 72 00 08 00 00 54 00 0D  
i2c w 40 73 00 08 C0 02 0C 00 0D  
i2c w 40 74 00 48 00 00 00 00 0D  
i2c w 40 75 00 08 00 00 4C 00 0D  
i2c w 40 76 15 08 00 00 34 00 0D  
i2c w 40 77 14 08 50 00 0C 00 0D  
i2c w 40 78 94 0A F0 00 0C 00 0D  
i2c w 40 79 94 0F 00 00 54 00 0D  
i2c w 40 7A 95 0E 10 00 0C 00 0D  
i2c w 40 7B 01 0E D0 00 0C 00 0D  
i2c w 40 7C 00 0E 00 00 AC 00 0D  
i2c w 40 7D 40 2E 00 00 00 00 0D  
i2c w 40 7E 40 08 70 00 0C 00 0D  
i2c w 40 7F 41 08 00 00 00 00 0D  
i2c w 40 80 29 48 00 00 00 00 0D  
i2c w 40 81 28 08 50 00 0C 00 0D  
i2c w 40 82 A8 0A F0 00 0C 00 0D  
i2c w 40 83 A8 0F 00 00 54 00 0D  
i2c w 40 84 A9 0E B0 06 50 00 0D  
i2c w 40 85 41 08 00 00 00 00 0D  
i2c w 40 86 0D 08 00 00 34 00 0D  
i2c w 40 87 0C 08 50 00 0C 00 0D  
i2c w 40 88 8C 0A F0 00 0C 00 0D  
i2c w 40 89 8C 0F 00 00 54 00 0D  
i2c w 40 8A 8D 0E 10 00 0C 00 0D  
i2c w 40 8B 01 0E D0 00 0C 00 0D  
i2c w 40 8C 00 0E 00 00 AC 00 0D  
i2c w 40 8D 40 2E 00 00 00 00 0D  
i2c w 40 8E 40 08 F0 06 94 00 0D

```

i2c w 40 8F 40 08 60 00 0C 00 0D
i2c w 40 90 41 08 00 00 00 00 0D
i2c w 40 91 31 48 00 00 00 00 0D
i2c w 40 92 30 08 50 00 0C 00 0D
i2c w 40 93 B0 0A F0 00 0C 00 0D
i2c w 40 94 B0 0F 00 00 54 00 0D
i2c w 40 95 B1 0E B0 06 50 00 0D
i2c w 40 96 43 08 00 00 00 00 0D
i2c w 40 97 41 08 00 00 00 00 0D
i2c w 40 98 3D 08 00 00 34 00 0D
i2c w 40 99 3C 08 50 00 0C 00 0D
i2c w 40 9A BC 0A F0 00 0C 00 0D
i2c w 40 9B BC 0F 00 00 54 00 0D
i2c w 40 9C BD 0E B0 06 50 00 0D
i2c w 47 00
i2c w 91 03

```

It is possible to read the sequencer code back from memory. This is useful to ensure that the sequencer code is correctly stored and was not accidentally changed during operation.

### 15.12. Pixel sequencer code readback

I2C command to imager	description / comment
i2c w a4 00	#disable acquisition
i2c w 91 00	#stop sequencer
i2c w 40 00 i2c w 47 09 Data0 = i2c r 41 Data1 = i2c r 42 Data2 = i2c r 43 Data3 = i2c r 44 Data4 = i2c r 45 Data5 = i2c r 46	#set dedicated sequencer RAM address (e.g. address 0x00) #enable pixel sequencer RAM access
i2c w 40 01 i2c w 47 09 Data0 = i2c r 41 Data1 = i2c r 42 Data2 = i2c r 43 Data3 = i2c r 44 Data4 = i2c r 45 Data5 = i2c r 46	#set dedicated sequencer RAM address (e.g. address 0x01) #enable pixel sequencer RAM access
...	...
i2c w 47 00	#disable pixel sequencer RAM access
i2c w 91 03	#start sequencer

#### Read back results (Sequencer V11)

RAM address pixel sequencer	Data0	Data1	Data2	Data3	Data4	Data5
0x00	0x43	0x10	0x00	0xC0	0x00	0x00
0x01	0x43	0x10	0x00	0x00	0x01	0x00
...	...	...	...	...	...	...

## 16. Addendum

### 16.1. Terms, definitions and abbreviations

Abbreviation	Term, Definition	Explanation
ABS	Automatic Backlight Suppression	
ADC	Analog Digital Converter	
AMR	Ratio of ambient-light / modulated light	
CGU	Clock Generation Unit	
CSP	Chip Scale Package	
CFG	Configuration	
DCS	Differential Correlation Sample	
DLL	Delay Locked Loop	Delay line only in the implementation of epc635
fps	Frames per second	
Half-QQVGA	1/8 of a Quarter VGA	160x60 pixel resolution
HDR	High Dynamic Range	
IC	Integrated Circuit	
IREF	Current reference	
LED/LD	Light Emitting Diode / Laser Diode	
LSB	Least Significant Bit	
MCU	Mikrocontroller	
MGA	Modulation Gate A	
MGB	Modulation Gate B	
MGX	Modulation Gate A or B	
mga	MGA control signal	
mgb	MGB control signal	
mgx	MGX control signal	
MSB	Most Significant Bit	
OSC	Oscillator	
PLL	Phase Locked Loop	
QVGA	Quarter VGA	320x240 pixel resolution
SGA	Storage Gate A	
SGB	Storage Gate B	
SGX	Storage Gate A or B	
TCMI	TOF Camera Module Interface	
TOF	Time of Flight	
VGA	Video Graphics Array	640x480 pixel resolution
XTAL	Crystal	

Table 40: Definitions and Abbreviations

### 16.2. Related documents

- 3D-TOF, A guideline to 3D-TOF sensors that work, Beat De Coi, ISBN 978-3-033-07096-7.
- Application note AN08 Process-Rules CSP Assembly, ESPROS Photonics corp.
- Application note AN10 Calibration and compensation of Cameras using ESPROS TOF Chips, ESPROS Photonics corp.
- Application note AN11 DME 660 Photobiological Safety Analysis, ESPROS Photonics Corp.
- Application note AN12 TOF data improvement toolbox, ESPROS Photonics Corp.
- NXP I<sup>2</sup>C-bus specification: I<sup>2</sup>C Bus Specification and User Manual, NXP corp.

## 17. IMPORTANT NOTICE

ESPROS Photonics AG and its subsidiaries (ESPROS) reserve the right to make corrections, modifications, enhancements, improvements, and other changes to its products and services at any time and to discontinue any product or service without notice. Customers should obtain the latest relevant information before placing orders and should verify that such information is current and complete. All products are sold subject to ESPROS' terms and conditions of sale supplied at the time of order acknowledgment.

ESPROS warrants performance of its hardware products to the specifications applicable at the time of sale in accordance with ESPROS' standard warranty. Testing and other quality control techniques are used to the extent ESPROS deems necessary to support this warranty. Except where mandated by government requirements, testing of all parameters of each product is not necessarily performed.

ESPROS assumes no liability for applications assistance or customer product design. Customers are responsible for their products and applications using ESPROS components. To minimize the risks associated with customer products and applications, customers should provide adequate design and operating safeguards.

ESPROS does not warrant or represent that any license, either express or implied, is granted under any ESPROS patent right, copyright, mask work right, or other ESPROS intellectual property right relating to any combination, machine, or process in which ESPROS products or services are used. Information published by ESPROS regarding third-party products or services does not constitute a license from ESPROS to use such products or services or a warranty or endorsement thereof. Use of such information may require a license from a third party under the patents or other intellectual property of the third party, or a license from ESPROS under the patents or other intellectual property of ESPROS.

Resale of ESPROS products or services with statements different from or beyond the parameters stated by ESPROS for that product or service voids all express and any implied warranties for the associated ESPROS product or service. ESPROS is not responsible or liable for any such statements.

ESPROS products are not authorized for use in safety-critical applications (such as life support) where a failure of the ESPROS product would reasonably be expected to cause severe personal injury or death, unless officers of the parties have executed an agreement specifically governing such use. Buyers represent that they have all necessary expertise in the safety and regulatory ramifications of their applications, and acknowledge and agree that they are solely responsible for all legal, regulatory and safety-related requirements concerning their products and any use of ESPROS products in such safety-critical applications, notwithstanding any applications-related information or support that may be provided by ESPROS. Further, Buyers must fully indemnify ESPROS and its representatives against any damages arising out of the use of ESPROS products in such safety-critical applications.

ESPROS products are neither designed nor intended for use in military/aerospace applications or environments unless the ESPROS products are specifically designated by ESPROS as military-grade. Only products designated by ESPROS as military-grade meet military specifications. Buyers acknowledge and agree that any such use of ESPROS products which ESPROS has not designated as military-grade is solely at the Buyer's risk, and that they are solely responsible for compliance with all legal and regulatory requirements in connection with such use.

ESPROS products are neither designed nor intended for use in automotive applications or environments unless the specific ESPROS products are designated by ESPROS as compliant with ISO/TS 16949 requirements. Buyers acknowledge and agree that, if they use any non-designated products in automotive applications, ESPROS will not be responsible for any failure to meet such requirements.