

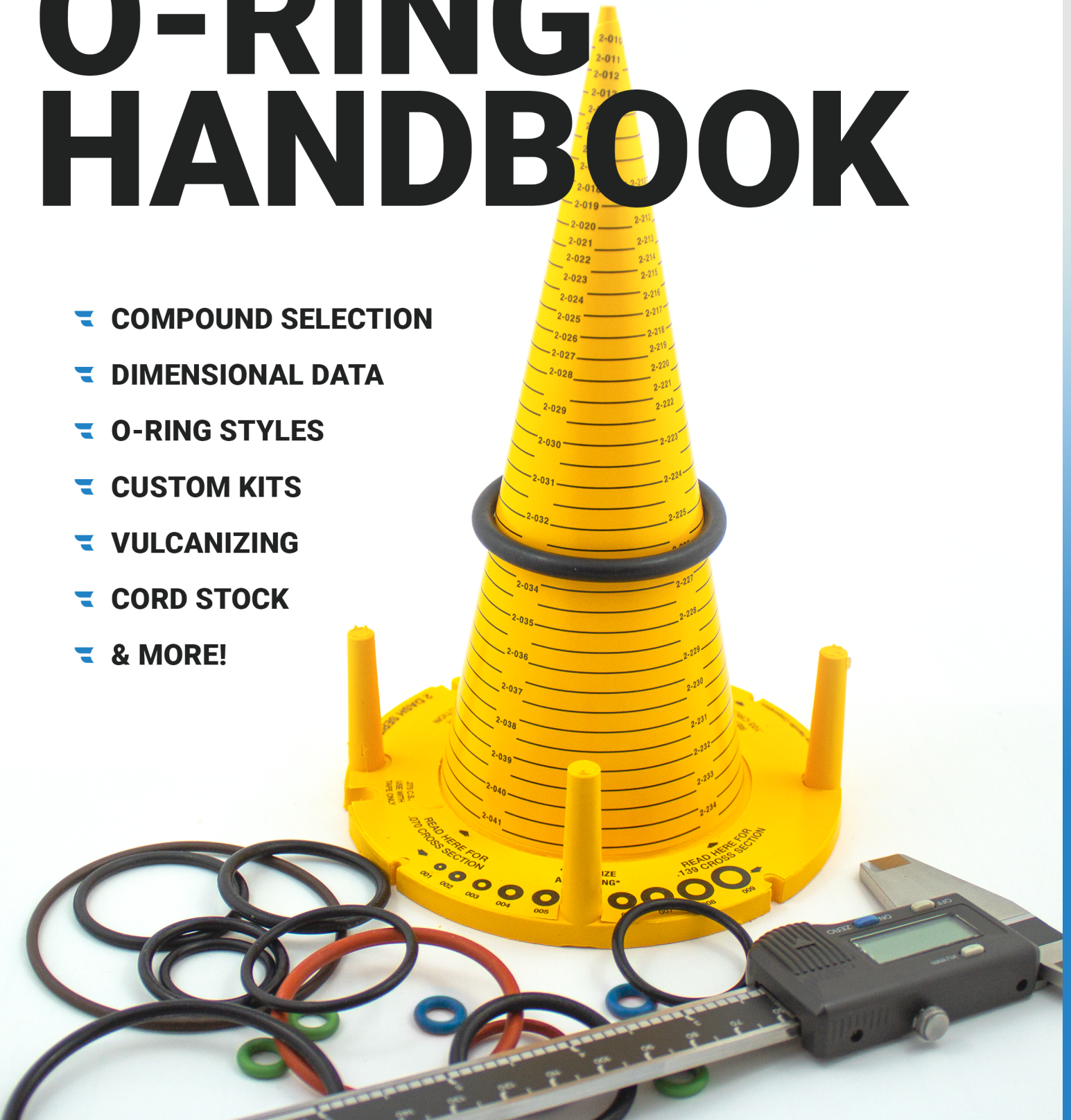

O-RING HANDBOOK

- **COMPOUND SELECTION**
- **DIMENSIONAL DATA**
- **O-RING STYLES**
- **CUSTOM KITS**
- **VULCANIZING**
- **CORD STOCK**
- **& MORE!**



Who are we?

APG was founded in 1943 and remains a leading manufacturer and master distributor in the fluid sealing industry. We are globally recognized as an ISO9001:2015 registered company specializing in the manufacture and supply of quality sealing, coupling and other industrial solutions.

Our ability to adopt new technologies, striving for continuous improvement of our processes, and the forming of long-lasting, strategic partnerships have given our distributors a competitive advantage and the capacity to remain relevant in today's ever-changing marketplace.

We've solidified distribution points across the globe to ensure our stock remains plentiful and available at a moment's notice, we've invested in state-of-the-art machinery to increase the efficiency of custom fabricated items and we've created various internal processes to ensure a constant stream of new products are being introduced strategically throughout the year.

This, among many other reasons, is why APG has been **Trusted since 1943™**.

Our Mission

to provide the **correct answer** the first-time and the **right product** on-time, **every-time**.



Our Values



SERVICE Our heart is in **servicing** our customer and communities.



CHANGE We understand change is the foundation of all improvement and **embrace** it.



ACCOUNTABILITY We keep our commitments and are **accountable** for our actions.



EMPOWERMENT We believe the **freedom to operate**, within a framework, is vital to our success.



HONESTY We always do the right thing and **never** put profits ahead of ethics.

apg™ Product Linecard

Sealing



O-Rings



O-Ring Cord



Seals



Kits



Vulcanized O-Rings



Gaskets



Sheet Materials



Packing Material



Accessories

Industrial Couplings



Cam & Groove Couplings



Valves



Pressure & Water Gauges



Components



Accessories



Crimp Sleeves & Ferrules



Pneumatic Fittings



Multi-Purpose Fittings



Ground Joints

Industrial Glass



Flat



Tubular Gage Glass



Annular



Accessories

Plastics



Replacement Visors



Headgear



Sandblast Lenses



Blast Cabinet Underlayment

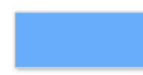

Respirator Cover Lenses

Raw Materials



O-Ring Cord



Sheet Materials



Packing Materials



Sheet Plastics

APG O-Ring Compounds and Styles

At press time for the printing of the catalog, the following represented a complete listing of O-Ring compounds and styles inventoried by APG as standard stock items. (APG Style Numbers are listed in parenthesis). Other options may now be available as standard items or by special order. Please inquire.

O-Rings

Aflas® 80 Durometer	(A80)
Chloroprene 70 Durometer	(N70)
E.P.R. 70 Durometer	
Standard	(E70)
Metric	(E)
Peroxide Cured NSF	(E70NSF)
E.P.R.- Peroxide Cured 80 Durometer	(E80PC)
*Fluoroelastomer – Black	
Standard	
75 Durometer	(V70)
90 Durometer	(V90)
Metric	
75 Durometer	(V)
90 Durometer	(V90M)
*Fluoroelastomer – Brown	
Standard	
75 Durometer	(VB75)
90 Durometer	(VB90)
Metric	
75 Durometer(VB75M)	
Fluoroelastomer FDA White	
60 Durometer	(V60FDA)
Fluorosilicone 70 Durometer	(FS70)
FKM Metal Detectable Blue	(V75MD)
Highly Saturated Nitrile	
Green 70 Durometer	
Standard	(HS70)
Metric	(HS)
Black 70 Durometer	(HSN70)
Black 90 Durometer	(HSN90)
Blue TFE Coated 70 Durometer	(HST70)
Kalrez® 4079	(K4079)
Nitrile - Black	
Standard	
50 Durometer	(H50)
70 Durometer	(H70)
90 Durometer	(H90)
Metric	
70 Durometer	(H)
90 Durometer	(H90M)
Nitrile Peroxide Cured	
90 Durometer	(H90PC)
Nitrile Metal Detectable	
70 Durometer	(H70MD)
Large Cross Section	
70 Durometer	(HX70)
Nitrile FDA White 70 Durometer	(H70FDA)
PTFE	(TFE)

O-Rings (Cont.)

Silicone 70 Durometer	
Standard	(S70)
Metric	(S)
Metal Detectable	(S70MD)
FDA	(S70FDA)
Square Cut Rings	
Nitrile 70 Durometer	(SH70)
Teflon® Encapsulated	
Viton® Core	(TEV80)
Silicone Core	(TES70)
Urethane	
70 Durometer	(U70)
90 Durometer	(U90)
4 Lobe Q-Rings	
Nitrile 70 Durometer	(QH70)
Fluoroelastomer 75 Durometer	(QV70)
Minnesota Quad-Rings®	
Nitrile 70 Durometer	HQ4)
Viton® 70 Duromete	(VQ4)

Back-Up Rings

PTFE	
Solid	(TST)
Split	(TST)
Spiral	(TSP)
Contoured Back-Up Rings	
Nitrile 90 Durometer	(HB90)
Fluoroelastomer 90 Durometer	(VBU90)
Leather	(Cut for Series 6244 & Series 6246)

*APG stocks the Type "A" Grade Fluoroelastomer. Other Grades are available. Please inquire.

Elastomer Descriptions and Properties

Nitrile

(Buna-N)

Trade Names:

Chemigum (Goodyear)
Hycar (Zeon Chemical)

Ny Syn (Copolymer)
Paracril (Uniroyal)

Krynac (Polysar)
Perbunan (Mobay)

The most widely used O-Ring elastomer. Excellent resistance to petroleum products. Excellent compression set, tear and abrasion resistance. Does not have good resistance to ozone, sunlight, or weather, unless specifically compounded. Should not be stored in direct sunlight or near motors or other electrical equipment which may generate ozone. Temperature range: -40° to +250°F.

*Fluoroelastomer

Trade Names:

Viton (E.I. duPont)

Fluorel (3M)

Excellent mechanical and physical properties. Good resistance to petroleum products, low compression set, and high temperature resistance. Wide spectrum of chemical compatibility. Good for vacuum service and low gas permeability. Temperature range: -15° to +400°F (limited exposures to higher temperatures).

*APG stocks the Type "A" Grade Fluoroelastomer. Other Grades are available. Please inquire.

Chloroprene

(Neoprene)

Trade Names:

Neoprene (E.I. duPont)

Butachlor (Ditsugil)

Bayprene (Mobay)

Moderately resistant to petroleum products. Good ozone and weather resistance. Good compression set. Excellent for sealing refrigeration fluids such as Freon®. Temperature range: -65° to +250°F.

Silicone

Trade Names:

Silastic (Dow)

Recommended for applications requiring a wide temperature range and good dry heat resistance. Good weather and ozone resistance. Limited oil resistance. Not normally recommended for dynamic sealing applications due to relatively poor tensile and tear strength and relatively low abrasion resistance. Temperature range: -80° to + 450°F.

Highly Saturated Nitrile

(HSN, HNBR)

Better resistance to high temperatures, superior physical properties, and improved chemical resistance over traditional nitrile compounds. It also has better resistance to ozone, sunlight, and other atmospheric conditions. Excellent resistance to compression set. Green HSN is used in refrigerant R134a applications. Temperature range: - 40°F to +325°F.

Ethylene Propylene

(EPM, EPDM) (EPR)

Trade Names:

Nordel (E.I. DuPont)
Vistalon (Exxon Chemical)

Royalene (Uniroyal)
Epcar (B. F. Goodrich)

Epsyn (Copolymer Rubber)

Excellent resistance to Skydrol® fluids used in commercial aircraft hydraulic systems. Also, recommended for hot water, steam, and phosphate ester type hydraulic fluids. Also resistant to some acids, alkalies, and ozone. Not recommended for petroleum fluids or diester lubricants. Temperature range: -65° to +300°F.

PTFE

Trade Name:

Teflon® (E.I. duPont)

White thermoplastic fluoroethylene resin offers a combination of qualities not found in any other material-chemical inertness, heat resistance, low friction, dielectric strength, weatherability, zero water absorption, toughness, and flexibility. Temperature range: -65° to +500°F.

Aflas®

Trade Name:

Aflas® (Asahi Glass Co., Ltd.)

Advantageous combination of high temperature, chemical and electrical resistance properties. Recommended for oils and lubricants, hydraulic and brake fluids, transmission and power steering fluids, sour oil and gas (H₂S), amine corrosion inhibitors, ozone, steam, acids, bases, alcohols, and a variety of other chemicals. Temperature range: +25° to +450°F. (+500°F short term).

Urethane

(Polyurethane)

Trade Names:

Texin (Miles Chemical)
Adiprene (Uniroyal)

Cyanaprene (American Cyanamid)
Pellethane (Dow Chemical)

Resistant to petroleum oils, hydrocarbon fuels, oxygen, ozone, and weathering. Particularly recommended for hydraulic systems where high pressures, shock loads, wide metal tolerances, or abrasive contamination is anticipated. Not recommended for acids, ketones, and chlorinated hydrocarbons. Some urethanes are also sensitive to water and humidity. Temperature range: -65° to +200°F.

Teflon® Encapsulated

Seamless and uniform Teflon® FEP encapsulation which completely encloses a core material of either silicone or Viton® elastomer. Matches the chemical and temperature resistance of solid PTFE O-Rings and possesses the elasticity and recovery properties which are crucial in many sealing applications. *Complete technical information on Teflon® Encapsulated O-Rings is provided on pages 4 and 5.*

Fluorosilicone

(FVMQ)

Trade Names:

LS (Dow)

FSE (GE)

Good low/high temperature resistance. Excellent resistance to petroleum oils and fuels. Used in aerospace applications for fuel systems and systems requiring resistance to diester base lubricants to 350°F. Due to limited strength and abrasion resistance, this material is generally recommended for static applications only. Temperature range: -80° to +350/400°F.

Teflon™ Encapsulated O-Ring Technical Information

Composition and Structure

Teflon™ FEP Encapsulated o-rings consist of a seamless and uniform Teflon™ FEP encapsulation which completely encloses a core material of either silicone or Viton™ elastomer.

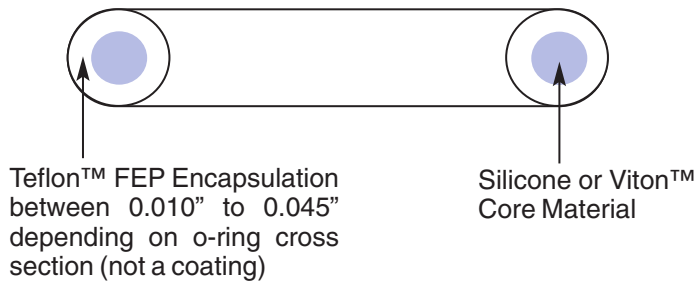

Function and Performance

The seamless, uniform, and integral Teflon™ FEP encapsulation is responsible for the sealing effect, and the elastomer core provides continuous reset and constant pressure of the encapsulation onto the sealing point. The result is an overall compression, increasing with medium pressure.

As a result, the Teflon™ FEP Encapsulated O-Rings can outperform solid PTFE O-Rings. The encapsulated o-rings match the chemical and temperature resistance of solid PTFE O-Rings and possess the elasticity and recovery properties which are crucial in many sealing applications.

Chemical attack and swelling are the primary causes of failure in o-rings. The Teflon™ FEP encapsulation is virtually chemically inert and not subject to most chemical attack. Temperature operating range -60°C/-75°F to +205°C/400°F.

Properties/Specifications

- (1) Encapsulation material: Teflon™ FEP resin (yielding high chemical resistance).
- (2) Core material: Silicone or Viton™ elastomers.
- (3) Operational temperature range: -60°C/-75°F to +205°C/400°F.
- (4) Coefficient of friction: .1 to .2
- (5) Elongation at break: 100%-156%
- (6) Water absorption: <0.01
- (7) Average total shore A hardness:
85-90 shore A-silicone core
90-95 shore A-Viton™ core
- (8) FDA Compliance: The clear Teflon™ FEP encapsulation complies with part 177 of Title 21 of the Food and Drug Administration's regulations for safe use as articles or components of articles for producing, manufacturing, processing, preparing, treating, packaging, transporting, or holding food in accordance with regulation 177.1550.

Industrial Applications

- Aircraft and Aerospace
- Chemical Processing Industries
- Pharmaceutical Production
- Polymer Production
- Paint and Coating Operations
- Food Industries
- Petrochemical Industries
- Chemical Transport
- Semi-Conductor Manufacturing
- Pulp and Paper Industries
- Photochemical Industries

Specific Applications

- Air Operated Pumps
- Mechanical Pumps
- Autoclaves
- Heat Exchangers
- Pipelines
- Pressure Vessels
- Valves
- Filtration Systems
- Gas Compressors

Gas Permeability

All plastics have some permeability to gases. In the case of Teflon™ FEP Encapsulated O-Rings, however, gases and vapors will permeate at a considerably lower rate than for most other plastics. The primary permeation mechanism is intermolecular migration. This migration rate depends on the type of gas, pressure, temperature, size of contact areas, and thickness of encapsulation. While highly corrosive gases do not attack the Teflon™ FEP Encapsulation of the o-ring, they may eventually permeate through and damage the elastomer core and hence affect the mechanical properties. Thus, in addition to chemical resistance, these permeability effects must be considered in gas sealing systems.

Permeability of Teflon™ FEP Resins

(gm/100in²/24 hrs-1mil)¹ TABLE 1

GASES ²	23 °C/73 °F	35 °C/95 °F	50 °C/122 °F
Carbon Dioxide			
Helium			
Hydrogen Chloride			
Nitrogen	0.18		
Oxygen	0.39		
VAPORS³			
Acetic Acid		0.42	
Acetone	0.13	0.95	3.29
Acetophenone	0.47		
Benzene	0.15	0.64	
N-Butyl Ether	0.08		0.65
Carbon Tetrachloride	0.11	0.31	
Decane	0.72		1.03
Dipentene	0.17		0.35
Ethyl Acetate	0.06	0.77	2.90
Ethyl Alcohol	0.11	0.69	
Hexane		0.57	
Hydrochloric Acid (20%)	<0.01		
Methanol			5.61
Piperdine	0.04		
Skydrol Hydraulic Fluid	0.05		
Sodium Hydroxide (50%)	4x10 ⁻⁵		
Sulfuric Acid (98%)	8x10 ⁻⁶		
Toluene	0.37		2.93
Water	0.09	0.45	0.89

- Note that the permeation data listed in Table 1 is based on 0.001" thickness of Teflon™ FEP encapsulation. **The transmission rate significantly decreases when the thickness of encapsulation is increased. See water vapor transmission rate chart.**
- Test method: ASTM D-790-59 (at 1atm).
- Test method: ASTM E-96-53T (vapor Pressure).

Absorption

Teflon™ FEP Encapsulated O-Rings absorb practically no common acids or bases at temperatures as high as 200°C/329°F with exposures up to one year. Even the absorption of solvents is surprisingly small; weight increases are generally less than 1% at elevated temperatures and exposure times. Due to the Teflon™ FEP encapsulation, the effects of volume swell (one of the principal causes of seal failure) can be virtually ignored.

Water Vapor Transmission Rate of Teflon™ FEP Resins @ 40°C/104°F

Transmission Rate = gm/100in²/24hrs

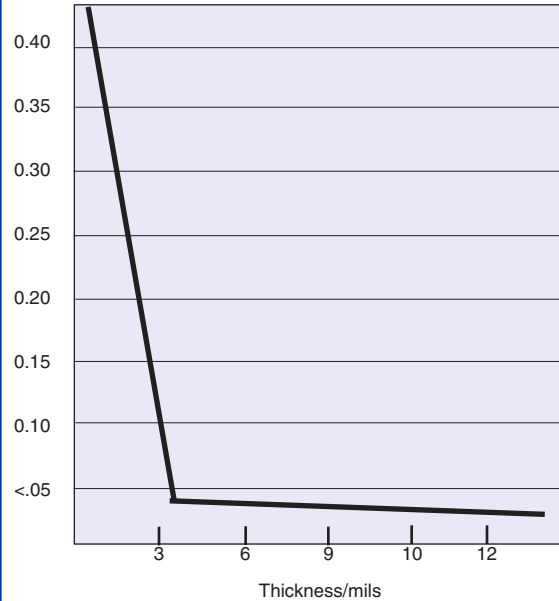

Please note that the vapor transmission rate significantly decreases when the thickness of encapsulation is increased

Thickness of Encapsulation

As discussed earlier, the thickness of encapsulation must be considered in determining migration rates. The thickness of the encapsulation varies with the cross section of the o-ring.

CROSS SECTION (mm/inches)	WALL SECTION (mm/inches)	CROSS SECTION (mm/inches)	WALL SECTION (mm/inches)
1.50mm/.059	0.203mm/.008	7.50mm/.295	0.508mm/.020
1.60mm/.063	0.203mm/.008	8.00mm/.312	0.508mm/.020
1.78mm/.070	0.254mm/.010	8.40mm/.330	0.508mm/.020
2.00mm/.079	0.254mm/.010	9.00mm/.354	0.508mm/.020
2.40mm/.094	0.254mm/.010	9.50mm/.374	0.508mm/.020
2.62mm/.103	0.279mm/.011	10.00mm/.393	0.508mm/.020
3.00mm/.118	0.279mm/.011	11.00mm/.433	0.762mm/.030
3.53mm/.139	0.305mm/.012	12.00mm/.472	0.762mm/.030
4.00mm/.157	0.305mm/.012	12.70mm/.500	0.762mm/.030
4.50mm/.177	0.381mm/.015	14.00mm/.551	0.762mm/.030
5.00mm/.196	0.381mm/.015	15.00mm/.591	0.762mm/.030
5.33mm/.210	0.381mm/.015	16.00mm/.625	0.762mm/.030
5.70mm/.225	0.381mm/.015	18.00mm/.708	0.762mm/.030
6.00mm/.236	0.381mm/.015	19.00mm/.750	0.762mm/.030
7.00mm/.275	0.508mm/.020	20.00mm/.787	0.762mm/.030

Final selection of applications must be based on functional evaluations or experience under actual end use conditions. This has become industry practice dictated by the many complex aspects of performance in severe conditions. The end user should thoroughly test any application, and independently conclude satisfactory performance of the product for his intended use, and shall assume all risk and liability whatsoever in connection therewith.

O-Ring Dimensional Data

Standard O-Ring Sizes and Tolerances

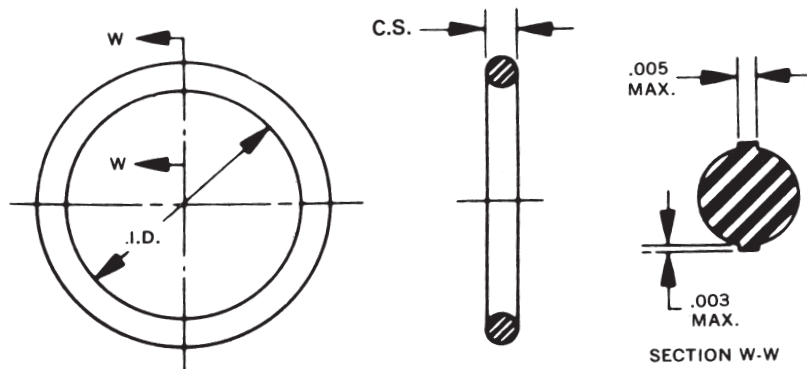

An O-Ring functions as a seal through the mechanical deformation of the elastomeric compound by mating metal surfaces. The resilient rubber conforms to the shape of the metal sections and blocks the passage of gases or liquids. If the pressure increases, the O-Ring is further deformed and provides tighter sealing.

The application of O-Rings is based on a volume relationship between the O-Ring and the gland. Experience has shown that O-Ring volume is not adversely affected by wider dimensional tolerances. Furthermore, Type II tolerances long in use for the fluoroelastomers and similar high shrinkage materials have proven to be as effective as seals molded to tighter tolerances. This is attributable to constant seal volume.

As a result of this, the latest revision of AS 568, formerly ARP 568 and now AS 568A, is a combination of Class I and II tolerances. This change is being incorporated in all military specifications and drawings as they come up for revision. Therefore, in the future, most AN, MS and NAS tolerance standards will conform to AS 568A. It should be recognized that standards apply both to dimensions, as shown, to drawing numbers, and to compounds, and that the military specifications will not be withdrawn, but updated to conform to a single dimensional specification. Various company standards probably also will be revised to meet this standard.

Through O-Ring industry sponsored technical committees, the United States is currently working with the International Standards Organization (ISO) to adapt AS 568A standard sizes to international metric requirements.

Tentative agreement has been reached on a size standard incorporating the existing five AS 568A cross sections and a series of ID dimensions determined by a logarithmic progression of the numbers. The result has been to increase the number of small sizes, i.e. to make the steps between sizes smaller, and to decrease the number of large sizes by widening the steps between sizes. This action is consistent with the assembly requirements of an O-Ring seal, and the elastic properties of O-Ring seal compounds.

Although some U.S. sizes will be deleted or modified in the new document, manufacturers will continue to manufacture existing sizes as long as there is demand.

The new ISO sizes will become available when approved by member nations. In the meantime, AS 568A contains metric equivalents in International System (SI) units. Calculation of these metric equivalents was done in accord with the rules appearing in SAE J390, Method A, rounding off tolerances as recommended.

Standard O-Ring Sizes and Dimensions

AS-568A UNIVERSAL DASH NUMBERS	AN 6227B AND AN 6230B PART NUMBERS	MS 28775 MS 29513 MS 29561 MS 9021 MS 9068 NAS 1593 NAS 1594 NAS 1611 DASH NUMBERS	AN 123856 ¹ TO AN 123934 PART NUMBERS	NOMINAL SIZE			INCH STANDARD		METRIC STANDARD (MM)	
				I.D.	O.D.	C.S.	I.D.	±	I.D.	±
				-004 to -050 Cross Section Diameters = .070 ± .003 inches — 1.78 ± 0.08 millimeters.						
★-001		-001**		1/32	x 3/32	x1/32	.029	.004	0.74	0.10
★-002		-002**		3/64	x 9/64	x1/32	.042	.004	1.07	0.10
★-003		-003**		1/16	x 3/16	x1/16	.056	.004	1.42	0.10
-004		-004		5/64	x 13/64	x1/16	.070	.005	1.78	0.13
-005		-005		3/32	x 7/32	x1/16	.101	.005	2.57	0.13
-006	AN 6227B-1	-006	AN 123856	1/8	x 1/4	x1/16	.114	.005	2.90	0.13
-007	AN 6227B-2	-007	AN 123857	5/32	x 9/32	x1/16	.145	.005	3.68	0.13
-008	AN 6227B-3	-008	AN 123858	3/16	x 5/16	x1/16	.176	.005	4.47	0.13
-009	AN 6227B-4	-009	AN 123859	7/32	x 11/32	x1/16	.208	.005	5.28	0.13
-010	AN 6227B-5	-010	AN 123860	1/4	x 3/8	x1/16	.239	.005	6.07	0.13
-011	AN 6227B-6	-011	AN 123861	5/16	x 7/16	x1/16	.301	.005	7.65	0.13
-012	AN 6227B-7	-012	AN 123862	3/8	x 1/2	x1/16	.364	.005	9.25	0.13
-013		-013		7/16	x 9/16	x1/16	.426	.005	10.82	0.13
-014		-014		1/2	x 5/8	x1/16	.489	.005	12.42	0.13
-015		-015		9/16	x 11/16	x1/16	.551	.007	14.00	0.18
-016		-016		5/8	x 3/4	x1/16	.614	.009	15.60	0.23
-017		-017		11/16	x 13/16	x1/16	.676	.009	17.17	0.23
-018		-018		3/4	x 7/8	x1/16	.739	.009	18.77	0.23
-019		-019		13/16	x 15/16	x1/16	.801	.009	20.35	0.23
-020		-020		7/8	x 1	x1/16	.864	.009	21.95	0.23
-021		-021		15/16	x1-1/16	x1/16	.926	.009	23.52	0.23
-022		-022		1	x1-1/8	x1/16	.989	.010	25.12	0.25
-023		-023		1-1/16	x1-3/16	x1/16	1.051	.010	26.70	0.25
-024		-024		1-1/8	x1-1/4	x1/16	1.114	.010	28.30	0.25
-025		-025		1-3/16	x1-5/16	x1/16	1.176	.011	29.87	0.28
-026		-026		1-1/4	x1-3/8	x1/16	1.239	.011	31.47	0.28
-027		-027		1-5/16	x1-7/16	x1/16	1.301	.011	33.05	0.28
-028		-028		1-3/8	x1-1/2	x1/16	1.364	.013	34.65	0.33
-029		-029*		1-1/2	x1-5/8	x1/16	1.489	.013	37.82	0.33
-030		-030*		1-5/8	x1-3/4	x1/16	1.614	.013	41.00	0.33
-031		-031*		1-3/4	x1-7/8	x1/16	1.739	.015	44.17	0.38
-032		-032*		1-7/8	x 2	x1/16	1.864	.015	47.35	0.38
-033		-033*		2	x2-1/8	x1/16	1.989	.018	50.52	0.46
-034		-034*		2-1/8	x2-1/4	x1/16	2.114	.018	53.70	0.46
-035		-035*		2-1/4	x2-3/8	x1/16	2.239	.018	56.87	0.46
-036		-036*		2-3/8	x2-1/2	x1/16	2.364	.018	60.05	0.46
-037		-037*		2-1/2	x2-5/8	x1/16	2.489	.018	63.22	0.46
-038		-038*		2-5/8	x2-3/4	x1/16	2.614	.020	66.40	0.51
-039		-039*		2-3/4	x2-7/8	x1/16	2.739	.020	69.57	0.51
-040		-040*		2-7/8	x 3	x1/16	2.864	.020	72.75	0.51
-041		-041*		3	x3-1/8	x1/16	2.989	.024	75.92	0.61
-042		-042*		3-1/4	x3-3/8	x1/16	3.239	.024	82.27	0.61
-043		-043*		3-1/2	x3-5/8	x1/16	3.489	.024	88.62	0.61
-044		-044*		3-3/4	x3-7/8	x1/16	3.739	.027	94.97	0.69
-045		-045*		4	x4-1/8	x1/16	3.989	.027	101.32	0.69

★ Cross Section Diameter: -001 = .040 ± .003 in. -002 = .050 ± .003 in. -003 = .060 ± .003 in.
 = 1.02 ± .08 mm. = 1.27 ± .08 mm. = 1.52 ± .08 mm.

¹ For AN 123956 to AN 124034, add 100 to part numbers shown in this column.
* These dash numbers are not included in MS 28775, MS 29561 or NAS 1611 series.
** These dash numbers are not included in MS 9068, MS 29561, NAS 1593 or NAS 1594 series.

NOTES: (1) "AN", "MS", and "NAS" information is for size cross-reference only. "AN", "MS", and "NAS" O-Rings require special compounds. APG O-Rings are available in a variety of compounds.
(2) Actual dimensions for standard (AN) shrinkage materials only. These correspond to AS568A dimensions. O-Rings manufactured out of compounds with different shrinkage rates (other than AN) will produce slightly different dimensions and tolerances.

Standard O-Ring Sizes and Dimensions (Continued)

AS-568A UNIVERSAL DASH NUMBERS	AN 6227B AND AN 6230B PART NUMBERS	MS 28775 MS 29513 MS 29561 MS 9021 MS 9068 NAS 1593 NAS 1594 NAS 1611 DASH NUMBERS	AN 123856 ¹ TO AN 123934 PART NUMBERS	NOMINAL SIZE			INCH STANDARD		METRIC STANDARD (MM)	
				I.D.	O.D.	C.S.	I.D.	±	I.D.	±
-004 to -050 Cross Section Diameters = .070 ± .003 inches — 1.78 ± 0.08 millimeters.										
-046		-046*††		4-1/4	x4-3/8	x1/16	4.239	.030	107.67	0.76
-047		-047*††		4-1/2	x4-5/8	x1/16	4.489	.030	114.02	0.76
-048		-048*††		4-3/4	x4-7/8	x1/16	4.739	.030	120.37	0.76
-049		-049*††		5	x5-1/8	x1/16	4.989	.037	126.72	0.94
-050		-050*††		5-1/4	x5-3/8	x1/16	5.239	.037	133.07	0.94
-102 to -178 Cross Section Diameters = .103 ± .003 inches — 2.62 ± 0.08 millimeters.										
-102				1/16	x 1/4	x3/32	.049	.005	1.24	0.10
-103				3/32	x 9/32	x3/32	.081	.005	2.06	0.13
-104				1/8	x 5/16	x3/32	.112	.005	2.84	0.13
-105				5/32	x 11/32	x3/32	.143	.005	3.63	0.13
-106				3/16	x 3/8	x3/32	.174	.005	4.42	0.13
-107				7/32	x 13/32	x3/32	.206	.005	5.23	0.13
-108				1/4	x 7/16	x3/32	.237	.005	6.02	0.13
-109				5/16	x 1/2	x3/32	.299	.005	7.59	0.13
-110	AN 6227B-8	-110	AN 123863	3/8	x 9/16	x3/32	.362	.005	9.19	0.13
-111	AN 6227B-9	-111	AN 123864	7/16	x 5/8	x3/32	.424	.005	10.77	0.13
-112	AN 6227B-10	-112	AN 123865	1/2	x 11/16	x3/32	.487	.005	12.37	0.13
-113	AN 6227B-11	-113	AN 123866	9/16	x 3/4	x3/32	.549	.007	13.94	0.18
-114	AN 6227B-12	-114	AN 123867	5/8	x 13/16	x3/32	.612	.009	15.54	0.23
-115	AN 6227B-13	-115	AN 123868	11/16	x 7/8	x3/32	.674	.009	17.12	0.23
-116	AN 6227B-14	-116	AN 123869	3/4	x 15/16	x3/32	.737	.009	18.72	0.23
-117		-117		13/16	x 1	x3/32	.799	.010	20.29	0.25
-118		-118		7/8	x1-1/16	x3/32	.862	.010	21.89	0.25
-119		-119		15/16	x1-1/8	x3/32	.924	.010	23.47	0.25
-120		-120		1	x1-3/16	x3/32	.987	.010	25.07	0.25
-121		-121		1-1/16	x1-1/4	x3/32	1.049	.010	26.64	0.25
-122		-122		1-1/8	x1-5/16	x3/32	1.112	.010	28.24	0.25
-123		-123		1-3/16	x1-3/8	x3/32	1.174	.012	29.82	0.30
-124		-124		1-1/4	x1-7/16	x3/32	1.237	.012	31.42	0.30
-125		-125		1-5/16	x1-1/2	x3/32	1.299	.012	32.99	0.30
-126		-126		1-3/8	x1-9/16	x3/32	1.362	.012	34.59	0.30
-127		-127		1-7/16	x1-5/8	x3/32	1.424	.012	36.17	0.30
-128		-128		1-1/2	x1-11/16	x3/32	1.487	.012	37.77	0.30
-129		-129		1-9/16	x1-3/4	x3/32	1.549	.015	39.34	0.38
-130		-130		1-5/8	x1-13/16	x3/32	1.612	.015	40.94	0.38
-131		-131		1-11/16	x1-7/8	x3/32	1.674	.015	42.52	0.38
-132		-132		1-3/4	x1-15/16	x3/32	1.737	.015	44.12	0.38
-133		-133		1-13/16	x 2	x3/32	1.799	.015	45.69	0.38
-134		-134		1-7/8	x2-1/16	x3/32	1.862	.015	47.29	0.38
-135		-135		1-15/16	x2-1/8	x3/32	1.925	.017	48.90	0.43
-136		-136		2	x2-3/16	x3/32	1.987	.017	50.47	0.43
-137		-137		2-1/16	x2-1/4	x3/32	2.050	.017	52.07	0.43
-138		-138		2-1/8	x2-5/16	x3/32	2.112	.017	53.64	0.43
-139		-139		2-3/16	x2-3/8	x3/32	2.175	.017	55.25	0.43
-140		-140		2-1/4	x2-7/16	x3/32	2.237	.017	56.82	0.43

¹ For AN 123956 to AN 124034, add 100 to part numbers shown in this column.
^{*} These dash numbers are not included in MS 28775, MS 29561 or NAS 1611 series.
^{**} These dash numbers are not included in MS 9068, MS 29561, NAS 1593 or NAS 1594 series.

NOTES: (1) "AN", "MS", and "NAS" information is for size cross-reference only. "AN", "MS", and "NAS" O-Rings require special compounds. APG O-Rings are available in a variety of compounds.
(2) Actual dimensions for standard (AN) shrinkage materials only. These correspond to AS568A dimensions. O-Rings manufactured out of compounds with different shrinkage rates (other than AN) will produce slightly different dimensions and tolerances.

Standard O-Ring Sizes and Dimensions (Continued)

AS-568A UNIVERSAL DASH NUMBERS	AN 6227B AND AN 6230B PART NUMBERS	MS 28775 MS 29513 MS 29561 MS 9021 MS 9068 NAS 1593 NAS 1594 NAS 1611 DASH NUMBERS	AN 123856 ¹ TO AN 123934 PART NUMBERS	NOMINAL SIZE			INCH STANDARD		METRIC STANDARD (MM)	
				I.D.	O.D.	C.S.	I.D.	±	I.D.	±
				-102 to -178 Cross Section Diameters = .103 + .003 inches — 2.62 + 0.08 millimeters.						
-141		-141		2-5/16	x2-1/2	x3/32	2.300	.020	58.42	0.51
-142		-142		2-3/8	x2-9/16	x3/32	2.362	.020	59.99	0.51
-143		-143		2-7/16	x2-5/8	x3/32	2.425	.020	61.60	0.51
-144		-144		2-1/2	x2-11/16	x3/32	2.487	.020	63.17	0.51
-145		-145		2-9/16	x2-3/4	x3/32	2.550	.020	64.77	0.51
-146		-146		2-5/8	x2-13/16	x3/32	2.612	.020	66.34	0.51
-147		-147		2-11/16	x2-7/8	x3/32	2.675	.022	67.95	0.56
-148		-148		2-3/4	x2-15/16	x3/32	2.737	.022	69.52	0.56
-149		-149		2-13/16	x3	x3/32	2.800	.022	71.12	0.56
-150		-150*		2-7/8	x3-1/16	x3/32	2.862	.022	72.69	0.56
-151		-151*		3	x3-3/16	x3/32	2.987	.024	75.87	0.61
-152		-152*		3-1/4	x3-7/16	x3/32	3.237	.024	82.22	0.61
-153		-153*		3-1/2	x3-11/16	x3/32	3.487	.024	88.57	0.61
-154		-154*		3-3/4	x3-15/16	x3/32	3.737	.028	94.92	0.71
-155		-155*		4	x4-3/16	x3/32	3.987	.028	101.27	0.71
-156		-156*		4-1/4	x4-7/16	x3/32	4.237	.030	107.62	0.76
-157		-157*		4-1/2	x4-11/16	x3/32	4.487	.030	113.97	0.76
-158		-158*		4-3/4	x4-15/16	x3/32	4.737	.030	120.32	0.76
-159		-159*		5	x5-3/16	x3/32	4.987	.035	126.67	0.89
-160		-160*		5-1/4	x5-7/16	x3/32	5.237	.035	133.02	0.89
-161		-161*		5-1/2	x5-11/16	x3/32	5.487	.035	139.37	0.89
-162		-162*		5-3/4	x5-15/16	x3/32	5.737	.035	145.72	0.89
-163		-163*††		6	x6-3/16	x3/32	5.987	.035	152.07	0.89
-164		-164*††		6-1/4	x6-7/16	x3/32	6.237	.040	158.42	1.02
-165		-165*††		6-1/2	x6-11/16	x3/32	6.487	.040	164.77	1.02
-166		-166*††		6-3/4	x6-15/16	x3/32	6.737	.040	171.12	1.02
-167		-167*††		7	x7-3/16	x3/32	6.987	.040	177.47	1.02
-168		-168*††		7-1/4	x7-7/16	x3/32	7.237	.045	183.82	1.14
-169		-169*††		7-1/2	x7-11/16	x3/32	7.487	.045	190.17	1.14
-170		-170*††		7-3/4	x7-15/16	x3/32	7.737	.045	196.52	1.14
-171		-171*††		8	x8-3/16	x3/32	7.987	.045	202.87	1.14
-172		-172*††		8-1/4	x8-7/16	x3/32	8.237	.050	209.22	1.27
-173		-173*††		8-1/2	x8-11/16	x3/32	8.487	.050	215.57	1.27
-174		-174*††		8-3/4	x8-15/16	x3/32	8.737	.050	221.92	1.27
-175		-175*††		9	x9-3/16	x3/32	8.987	.050	228.27	1.27
-176		-176*††		9-1/4	x9-7/16	x3/32	9.237	.055	234.62	1.40
-177		-177*††		9-1/2	x9-11/16	x3/32	9.487	.055	240.97	1.40
-178		-178*††		9-3/4	x9-15/16	x3/32	9.737	.055	247.32	1.40
-201 to -284 Cross Section Diameters = .139 + .004 inches — 3.53 + 0.10 millimeters.										
-201				3/16	x 7/16	x1/8	.171	.005	4.34	0.13
-202				1/4	x 1/2	x1/8	.234	.005	5.94	0.13
-203				5/16	x 9/16	x1/8	.296	.005	7.52	0.13
-204				3/8	x 5/8	x1/8	.359	.005	9.12	0.13
-205				7/16	x 11/16	x1/8	.421	.005	10.69	0.13

¹ For AN 123956 to AN 124034, add 100 to part numbers shown in this column.
^{*} These dash numbers are not included in MS 28775, MS 29561 or NAS 1611 series.
^{**} These dash numbers are not included in MS 9068, MS 29561, NAS 1593 or NAS 1594 series.

NOTES: (1) "AN", "MS", and "NAS" information is for size cross-reference only. "AN", "MS", and "NAS" O-Rings require special compounds. APG O-Rings are available in a variety of compounds.
(2) Actual dimensions for standard (AN) shrinkage materials only. These correspond to AS568A dimensions. O-Rings manufactured out of compounds with different shrinkage rates (other than AN) will produce slightly different dimensions and tolerances.

Standard O-Ring Sizes and Dimensions (Continued)

AS-568A UNIVERSAL DASH NUMBERS	AN 6227B AND AN 6230B PART NUMBERS	MS 28775 MS 29513 MS 29561 MS 9021 MS 9068 NAS 1593 NAS 1594 NAS 1611 DASH NUMBERS	AN 123856 ¹ TO AN 123934 PART NUMBERS	NOMINAL SIZE			INCH STANDARD		METRIC STANDARD (MM)	
				I.D.	O.D.	C.S.	I.D.	±	I.D.	±
				-201 to -284 Cross Section Diameters = .139 ± .004 inches — 3.53 ± 0.10 millimeters.						
-206				1/2	x 3/4	x1/8	.484	.005	12.29	0.13
-207				9/16	x 13/16	x1/8	.546	.007	13.87	0.18
-208				5/8	x 7/8	x1/8	.609	.009	15.47	0.23
-209				11/16	x 15/16	x1/8	.671	.009	17.04	0.23
-210	AN 6227B-15	-210	AN 123870	3/4	x 1	x1/8	.734	.010	18.64	0.25
-211	AN 6227B-16	-211	AN 123871	13/16	x1-1/16	x1/8	.796	.010	20.22	0.25
-212	AN 6227B-17	-212	AN 123872	7/8	x1-1/8	x1/8	.859	.010	21.82	0.25
-213	AN 6227B-18	-213	AN 123873	15/16	x1-3/16	x1/8	.921	.010	23.39	0.25
-214	AN 6227B-19	-214	AN 123874	1	x1-1/4	x1/8	.984	.010	24.99	0.25
-215	AN 6227B-20	-215	AN 123875	1-1/16	x1-5/16	x1/8	1.046	.010	26.57	0.25
-216	AN 6227B-21	-216	AN 123876	1-1/8	x1-3/8	x1/8	1.109	.012	28.17	0.30
-217	AN 6227B-22	-217	AN 123877	1-3/16	x1-7/16	x1/8	1.171	.012	29.74	0.30
-218	AN 6227B-23	-218	AN 123878	1-1/4	x1-1/2	x1/8	1.234	.012	31.34	0.30
-219	AN 6227B-24	-219	AN 123879	1-5/16	x1-9/16	x1/8	1.296	.012	32.92	0.30
-220	AN 6227B-25	-220	AN 123880	1-3/8	x1-5/8	x1/8	1.359	.012	34.52	0.30
-221	AN 6227B-26	-221	AN 123881	1-7/16	x1-11/16	x1/8	1.421	.012	36.09	0.30
-222	AN 6227B-27	-222	AN 123882	1-1/2	x1-3/4	x1/8	1.484	.015	37.69	0.38
-223	AN 6230B-1	-223	AN 123883	1-5/8	x1-7/8	x1/8	1.609	.015	40.87	0.38
-224	AN 6230B-2	-224	AN 123884	1-3/4	x 2	x1/8	1.734	.015	44.04	0.38
-225	AN 6230B-3	-225	AN 123885	1-7/8	x2-1/8	x1/8	1.859	.018	47.22	0.46
-226	AN 6230B-4	-226	AN 123886	2	x2-1/4	x1/8	1.984	.018	50.39	0.46
-227	AN 6230B-5	-227	AN 123887	2-1/8	x2-3/8	x1/8	2.109	.018	53.57	0.46
-228	AN 6230B-6	-228	AN 123888	2-1/4	x2-1/2	x1/8	2.234	.020	56.74	0.51
-229	AN 6230B-7	-229	AN 123889	2-3/8	x2-5/8	x1/8	2.359	.020	59.92	0.51
-230	AN 6230B-8	-230	AN 123890	2-1/2	x2-3/4	x1/8	2.484	.020	63.09	0.51
-231	AN 6230B-9	-231	AN 123891	2-5/8	x2-7/8	x1/8	2.609	.020	66.27	0.51
-232	AN 6230B-10	-232	AN 123892	2-3/4	x 3	x1/8	2.734	.024	69.44	0.61
-233	AN 6230B-11	-233	AN 123893	2-7/8	x3-1/8	x1/8	2.859	.024	72.62	0.61
-234	AN 6230B-12	-234	AN 123894	3	x3-1/4	x1/8	2.984	.024	75.79	0.61
-235	AN 6230B-13	-235	AN 123895	3-1/8	x3-3/8	x1/8	3.109	.024	78.97	0.61
-236	AN 6230B-14	-236	AN 123896	3-1/4	x3-1/2	x1/8	3.234	.024	82.14	0.61
-237	AN 6230B-15	-237	AN 123897	3-3/8	x3-5/8	x1/8	3.359	.024	85.32	0.61
-238	AN 6230B-16	-238	AN 123898	3-1/2	x3-3/4	x1/8	3.484	.024	88.49	0.61
-239	AN 6230B-17	-239	AN 123899	3-5/8	x3-7/8	x1/8	3.609	.028	91.67	0.71
-240	AN 6230B-18	-240	AN 123900	3-3/4	x 4	x1/8	3.734	.028	94.84	0.71
-241	AN 6230B-19	-241	AN 123901	3-7/8	x4-1/8	x1/8	3.859	.028	98.02	0.71
-242	AN 6230B-20	-242	AN 123902	4	x4-1/4	x1/8	3.984	.028	101.19	0.71
-243	AN 6230B-21	-243	AN 123903	4-1/8	x4-3/8	x1/8	4.109	.028	104.37	0.71
-244	AN 6230B-22	-244	AN 123904	4-1/4	x4-1/2	x1/8	4.234	.030	107.54	0.76
-245	AN 6230B-23	-245	AN 123905	4-3/8	x4-5/8	x1/8	4.359	.030	110.72	0.76
-246	AN 6230B-24	-246	AN 123906	4-1/2	x4-3/4	x1/8	4.484	.030	113.89	0.76
-247	AN 6230B-25	-247	AN 123907	4-5/8	x4-7/8	x1/8	4.609	.030	117.07	0.76
-248	AN 6230B-26	-248†	AN 123908	4-3/4	x 5	x1/8	4.734	.030	120.24	0.76
-249	AN 6230B-27	-249†	AN 123909	4-7/8	x5-1/8	x1/8	4.859	.035	123.42	0.89
-250	AN 6230B-28	-250†	AN 123910	5	x5-1/4	x1/8	4.984	.035	126.59	0.89

¹ For AN 123956 to AN 124034, add 100 to part numbers shown in this column.
† These dash numbers are not included in MS 28775 series.

NOTES: (1) "AN", "MS", and "NAS" information is for size cross-reference only. "AN", "MS", and "NAS" O-Rings require special compounds. APG O-Rings are available in a variety of compounds.
(2) Actual dimensions for standard (AN) shrinkage materials only. These correspond to AS568A dimensions. O-Rings manufactured out of compounds with different shrinkage rates (other than AN) will produce slightly different dimensions and tolerances.

Standard O-Ring Sizes and Dimensions (Continued)

AS-568A UNIVERSAL DASH NUMBERS	AN 6227B AND AN 6230B PART NUMBERS	MS 28775 MS 29513 MS 29561 MS 9021 MS 9068 NAS 1593 NAS 1594 NAS 1611 DASH NUMBERS	AN 123856 ¹ TO AN 123934 PART NUMBERS	NOMINAL SIZE			INCH STANDARD		METRIC STANDARD (MM)	
				I.D.	O.D.	C.S.	I.D.	±	I.D.	±
-201 to -284 Cross Section Diameters = .139 ± .004 inches — 3.53 ± 0.10 millimeters.										
-251	AN 6230B29	-251†	AN 123911	5-1/8	x5-3/8	x1/8	5.109	.035	129.77	0.89
-252	AN 6230B30	-252†	AN 123912	5-1/4	x5-1/2	x1/8	5.234	.035	132.94	0.89
-253	AN 6230B31	-253†	AN 123913	5-3/8	x5-5/8	x1/8	5.359	.035	136.12	0.89
-254	AN 6230B32	-254†	AN 123914	5-1/2	x5-3/4	x1/8	5.484	.035	139.29	0.89
-255	AN 6230B33	-255†	AN 123915	5-5/8	x5-7/8	x1/8	5.609	.035	142.47	0.89
-256	AN 6230B34	-256†	AN 123916	5-3/4	x 6	x1/8	5.734	.035	145.64	0.89
-257	AN 6230B35	-257†	AN 123917	5-7/8	x6-1/8	x1/8	5.859	.035	148.82	0.89
-258	AN 6230B36	-258†	AN 123918	6	x6-1/4	x1/8	5.984	.035	151.99	0.89
-259	AN 6230B37	-259†	AN 123919	6-1/4	x6-1/2	x1/8	6.234	.040	158.34	1.02
-260	AN 6230B38	-260†	AN 123920	6-1/2	x6-3/4	x1/8	6.484	.040	164.69	1.02
-261	AN 6230B39	-261†	AN 123921	6-3/4	x 7	x1/8	6.734	.040	171.04	1.02
-262	AN 6230B40	-262†	AN 123922	7	x7-1/4	x1/8	6.984	.040	177.39	1.02
-263	AN 6230B41	-263†	AN 123923	7-1/4	x7-1/2	x1/8	7.234	.045	183.74	1.14
-264	AN 6230B42	-264†	AN 123924	7-1/2	x7-3/4	x1/8	7.484	.045	190.09	1.14
-265	AN 6230B43	-265†	AN 123925	7-3/4	x 8	x1/8	7.734	.045	196.44	1.14
-266	AN 6230B44	-266†	AN 123926	8	x8-1/4	x1/8	7.984	.045	202.79	1.14
-267	AN 6230B45	-267†	AN 123927	8-1/4	x8-1/2	x1/8	8.234	.050	209.14	1.27
-268	AN 6230B46	-268†	AN 123928	8-1/2	x8-3/4	x1/8	8.484	.050	215.49	1.27
-269	AN 6230B47	-269†	AN 123929	8-3/4	x 9	x1/8	8.734	.050	221.84	1.27
-270	AN 6230B48	-270†	AN 123930	9	x9-1/4	x1/8	8.984	.050	228.19	1.27
-271	AN 6230B49	-271†	AN 123931	9-1/4	x9-1/2	x1/8	9.234	.055	234.54	1.40
-272	AN 6230B50	-272†	AN 123932	9-1/2	x9-3/4	x1/8	9.484	.055	240.89	1.40
-273	AN 6230B51	-273†	AN 123933	9-3/4	x 10	x1/8	9.734	.055	247.24	1.40
-274	AN 6230B52	-274†	AN 123934	10	x10-1/4	x1/8	9.984	.055	253.59	1.40
-275		-275*		10-1/2	x10-3/4	x1/8	10.484	.055	266.29	1.40
-276		-276*		11	x11-1/4	x1/8	10.984	.065	278.99	1.65
-277		-277*		11-1/2	x11-3/4	x1/8	11.484	.065	291.69	1.65
-278		-278*		12	x12-1/4	x1/8	11.984	.065	304.39	1.65
-279		-279*		13	x13-1/4	x1/8	12.984	.065	329.79	1.65
-280		-280*		14	x14-1/4	x1/8	13.984	.065	355.19	1.65
-281		-281*		15	x15-1/4	x1/8	14.984	.065	380.59	1.65
-282		-282*††		16	x16-1/4	x1/8	15.955	.075	405.26	1.90
-283		-283*††		17	x17-1/4	x1/8	16.955	.080	430.66	2.03
-284		-284*††		18	x18-1/4	x1/8	17.955	.085	456.06	2.16
-309 to -395 Cross Section Diameters = .210 ± .005 inches — 5.33 ± 0.13 millimeters.										
-309				7/16	x13/16	x3/16	.412	.005	10.46	0.13
-310				1/2	x7/8	x3/16	.475	.005	12.07	0.13
-311				9/16	x15/16	x3/16	.537	.007	13.64	0.18
-312				5/8	x1	x3/16	.600	.009	15.24	0.23
-313				11/16	x1-1/16	x3/16	.662	.009	16.81	0.23
-314				3/4	x1-1/8	x3/16	.725	.010	18.42	0.25
-315				13/16	x1-3/16	x3/16	.787	.010	19.99	0.25

1 For AN 123956 to AN 124034, add 100 to part numbers shown in this column.
* These dash numbers are not included in MS 28775, MS 29561 or NAS 1611 series.
† These dash numbers are not included in MS 28775.
†† These dash numbers are not included in MS 9068, NAS 1593 or NAS 1594.

NOTES: (1) "AN", "MS", and "NAS" information is for size cross-reference only. "AN", "MS", and "NAS" O-Rings require special compounds. APG O-Rings are available in a variety of compounds.
(2) Actual dimensions for standard (AN) shrinkage materials only. These correspond to AS568A dimensions. O-Rings manufactured out of compounds with different shrinkage rates (other than AN) will produce slightly different dimensions and tolerances.

Standard O-Ring Sizes and Dimensions (Continued)

AS-568A UNIVERSAL DASH NUMBERS	AN 6227B AND AN 6230B PART NUMBERS	MS 28775 MS 29513 MS 29561 MS 9021 MS 9068 NAS 1593 NAS 1594 NAS 1611 DASH NUMBERS	AN 123856 ¹ TO AN 123934 PART NUMBERS	NOMINAL SIZE			INCH STANDARD		METRIC STANDARD (MM)	
				I.D.	O.D.	C.S.	I.D.	±	I.D.	±
				-309 to -395 Cross Section Diameters = .210 ± .005 inches — 5.33 ± 0.13 millimeters.						
-316				7/8	x1-1/4	x3/16	.850	.010	21.59	0.25
-317				15-16	x1-5/16	x3/16	.912	.010	23.16	0.25
-318				1	x1-3/8	x3/16	.975	.010	24.77	0.25
-319				1-1/16	x1-7/16	x3/16	1.037	.010	26.34	0.25
-320				1-1/8	x1-1/2	x3/16	1.100	.012	27.94	0.30
-321				1-3/16	x1-9/16	x3/16	1.162	.012	29.51	0.30
-322				1-1/4	x1-5/8	x3/16	1.225	.012	31.12	0.30
-323				1-5/16	x1-11/16	x3/16	1.287	.012	32.69	0.30
-324				1-3/8	x1-3/4	x3/16	1.350	.012	34.29	0.30
-325	AN 6227B-28	-325		1-1/2	x1-7/8	x3/16	1.475	.015	37.47	0.38
-326	AN 6227B-29	-326		1-5/8	x2	x3/16	1.600	.015	40.64	0.38
-327	AN 6227B-30	-327		1-3/4	x2-1/8	x3/16	1.725	.015	43.82	0.38
-328	AN 6227B-31	-328		1-7/8	x2-1/4	x3/16	1.850	.015	46.99	0.38
-329	AN 6227B-32	-329		2	x2-3/8	x3/16	1.975	.018	50.17	0.46
-330	AN 6227B-33	-330		2-1/8	x2-1/2	x3/16	2.100	.018	53.34	0.46
-331	AN 6227B-34	-331		2-1/4	x2-5/8	x3/16	2.225	.018	56.52	0.46
-332	AN 6227B-35	-332		2-3/8	x2-3/4	x3/16	2.350	.018	59.69	0.46
-333	AN 6227B-36	-333		2-1/2	x2-7/8	x3/16	2.475	.020	62.87	0.51
-334	AN 6227B-37	-334		2-5/8	x3	x3/16	2.600	.020	66.04	0.51
-335	AN 6227B-38	-335		2-3/4	x3-1/8	x3/16	2.725	.020	69.22	0.51
-336	AN 6227B-39	-336		2-7/8	x3-1/4	x3/16	2.850	.020	72.39	0.51
-337	AN 6227B-40	-337		3	x3-3/8	x3/16	2.975	.024	75.57	0.61
-338	AN 6227B-41	-338		3-1/8	x3-1/2	x3/16	3.100	.024	78.74	0.61
-339	AN 6227B-42	-339		3-1/4	x3-5/8	x3/16	3.225	.024	81.92	0.61
-340	AN 6227B-43	-340		3-3/8	x3-3/4	x3/16	3.350	.024	85.09	0.61
-341	AN 6227B-44	-341		3-1/2	x3-7/8	x3/16	3.475	.024	88.27	0.61
-342	AN 6227B-45	-342		3-5/8	x4	x3/16	3.600	.028	91.44	0.71
-343	AN 6227B-46	-343		3-3/4	x4-1/8	x3/16	3.725	.028	94.62	0.71
-344	AN 6227B-47	-344		3-7/8	x4-1/4	x3/16	3.850	.028	97.79	0.71
-345	AN 6227B-48	-345		4	x4-3/8	x3/16	3.975	.028	100.97	0.71
-346	AN 6227B-49	-346		4-1/8	x4-1/2	x3/16	4.100	.028	104.14	0.71
-347	AN 6227B-50	-347		4-1/4	x4-5/8	x3/16	4.225	.030	107.32	0.76
-348	AN 6227B-51	-348		4-3/8	x4-3/4	x3/16	4.350	.030	110.49	0.76
-349	AN 6227B-52	-349		4-1/2	x4-7/8	x3/16	4.475	.030	113.67	0.76
-350		-350*††		4-5/8	x5	x3/16	4.600	.030	116.84	0.76
-351		-351*††		4-3/4	x5-1/8	x3/16	4.725	.030	120.02	0.76
-352		-352*††		4-7/8	x5-1/4	x3/16	4.850	.030	123.19	0.76
-353		-353*††		5	x5-3/8	x3/16	4.975	.037	126.37	0.94
-354		-354*††		5-1/8	x5-1/2	x3/16	5.100	.037	129.54	0.94
-355		-355*††		5-1/4	x5-5/8	x3/16	5.225	.037	132.72	0.94
-356		-356*††		5-3/8	x5-3/4	x3/16	5.350	.037	135.89	0.94
-357		-357*††		5-1/2	x5-7/8	x3/16	5.475	.037	139.07	0.94
-358		-358*††		5-5/8	x6	x3/16	5.600	.037	142.24	0.94
-359		-359*††		5-3/4	x6-1/8	x3/16	5.725	.037	145.42	0.94
-360		-360*††		5-7/8	x6-1/4	x3/16	5.850	.037	148.59	0.94

1 For AN 123956 to AN 124034, add 100 to part numbers shown in this column.
 * These dash numbers are not included in MS 28775, MS 29561 or NAS 1611 series.
 †† These dash numbers are not included in MS 9068, NAS 1593 or NAS 1594.

NOTES: (1) "AN", "MS", and "NAS" information is for size cross-reference only. "AN", "MS", and "NAS" O-Rings require special compounds. APG O-Rings are available in a variety of compounds.
 (2) Actual dimensions for standard (AN) shrinkage materials only. These correspond to AS568A dimensions. O-Rings manufactured out of compounds with different shrinkage rates (other than AN) will produce slightly different dimensions and tolerances.

Standard O-Ring Sizes and Dimensions (Continued)

AS-568A UNIVERSAL DASH NUMBERS	AN 6227B AND AN 6230B PART NUMBERS	MS 28775 MS 29513 MS 29561 MS 9021 MS 9068 NAS 1593 NAS 1594 NAS 1611 DASH NUMBERS	AN 123856 ¹ TO AN 123934 PART NUMBERS	NOMINAL SIZE			INCH STANDARD		METRIC STANDARD (MM)	
				I.D.	O.D.	C.S.	I.D.	±	I.D.	±
				-309 to -395 Cross Section Diameters = .210 ± .005 inches — 5.33 ± 0.13 millimeters.						
-361		-361*††		6	x6-3/8	x3/16	5.975	.037	151.77	0.94
-362		-362*††		6-1/4	x6-5/8	x3/16	6.225	.040	158.12	1.02
-363		-363*††		6-1/2	x6-7/8	x3/16	6.475	.040	164.47	1.02
-364		-364*††		6-3/4	x7-1/8	x3/16	6.725	.040	170.82	1.02
-365		-365*††		7	x7-3/8	x3/16	6.975	.040	177.17	1.02
-366		-366*††		7-1/4	x7-5/8	x3/16	7.225	.045	183.52	1.14
-367		-367*††		7-1/2	x7-7/8	x3/16	7.475	.045	189.87	1.14
-368		-368*††		7-3/4	x8-1/8	x3/16	7.725	.045	196.22	1.14
-369		-369*††		8	x8-3/8	x3/16	7.975	.045	202.57	1.14
-370		-370*††		8-1/4	x8-5/8	x3/16	8.225	.050	208.92	1.27
-371		-371*††		8-1/2	x8-7/8	x3/16	8.475	.050	215.27	1.27
-372		-372*††		8-3/4	x9-1/8	x3/16	8.725	.050	221.62	1.27
-373		-373*††		9	x9-3/8	x3/16	8.975	.050	227.97	1.27
-374		-374*††		9-1/4	x9-5/8	x3/16	9.225	.055	234.32	1.40
-375		-375*††		9-1/2	x9-7/8	x3/16	9.475	.055	240.67	1.40
-376		-376*††		9-3/4	x10-1/8	x3/16	9.725	.055	247.02	1.40
-377		-377*††		10	x10-3/8	x3/16	9.975	.055	253.37	1.40
-378		-378*††		10-1/2	x10-7/8	x3/16	10.475	.060	266.07	1.52
-379		-379*††		11	x11-3/8	x3/16	10.975	.060	278.77	1.52
-380		-380*††		11-1/2	x11-7/8	x3/16	11.475	.065	291.47	1.65
-381		-381*††		12	x12-3/8	x3/16	11.975	.065	304.17	1.65
-382		-382*††		13	x13-3/8	x3/16	12.975	.065	329.57	1.65
-383		-383*††		14	x14-3/8	x3/16	13.975	.070	354.97	1.78
-384		-384*††		15	x15-3/8	x3/16	14.975	.070	380.37	1.78
-385		-385*††		16	x16-3/8	x3/16	15.955	.075	405.26	1.90
-386		-386*††		17	x17-3/8	x3/16	16.955	.080	430.66	2.03
-387		-387*††		18	x18-3/8	x3/16	17.955	.085	456.06	2.16
-388		-388*††		19	x19-3/8	x3/16	18.955	.090	481.38	2.29
-389		-389*††		20	x20-3/8	x3/16	19.955	.095	506.78	2.41
-390		-390*††		21	x21-3/8	x3/16	20.955	.095	532.18	2.41
-391		-391*††		22	x22-3/8	x3/16	21.955	.095	557.58	2.41
-392		-392*††		23	x23-3/8	x3/16	22.940	.105	582.68	2.67
-393		-393*††		24	x24-3/8	x3/16	23.940	.110	608.08	2.79
-394		-394*††		25	x25-3/8	x3/16	24.940	.115	633.48	2.92
-395		-395*††		26	x26-3/8	x3/16	25.940	.120	658.88	3.05
-400 to -424 Cross Section Diameters = .275 ± .006 inches — 6.99 ± 0.15 millimeters.										
-400***				1-3/8	x1-7/8	x1/4	1.350	.014	34.29	0.36
-401***				1-1/2	x2	x1/4	1.475	.014	37.47	0.36
-402***				1-5/8	x2-1/8	x1/4	1.600	.015	40.64	0.38
-403***				1-3/4	x2-1/4	x1/4	1.725	.016	43.82	0.41
-404***				1-7/8	x2-3/8	x1/4	1.850	.017	46.99	0.43

¹ For AN 123956 to AN 124034, add 100 to part numbers shown in this column.
* These dash numbers are not included in MS 28775, MS 29561 or NAS 1611 series.
*** Dash numbers 400-424 are not listed on AS 568A, but are stock items at American Packing in selected compounds.
†† These dash numbers are not included in MS 9068, NAS 1593 or NAS 1594.

NOTES: (1) "AN", "MS", and "NAS" information is for size cross-reference only. "AN", "MS", and "NAS" O-Rings require special compounds. APG O-Rings are available in a variety of compounds.
(2) Actual dimensions for standard (AN) shrinkage materials only. These correspond to AS568A dimensions. O-Rings manufactured out of compounds with different shrinkage rates (other than AN) will produce slightly different dimensions and tolerances.

Standard O-Ring Sizes and Dimensions (Continued)

AS-568A UNIVERSAL DASH NUMBERS	AN 6227B AND AN 6230B PART NUMBERS	MS 28775 MS 29513 MS 29561 MS 9021 MS 9068 NAS 1593 NAS 1594 NAS 1611 DASH NUMBERS	AN 123856 ¹ TO AN 123934 PART NUMBERS	NOMINAL SIZE			INCH STANDARD		METRIC STANDARD (MM)	
				I.D.	O.D.	C.S.	I.D.	±	I.D.	±
-400 to -424 Cross Section Diameters = .275 ± .006 inches — 6.99 ± 0.15 millimeters.										
-405***				2	x2-1/2	x1/4	1.975	.017	50.17	0.43
-406***				2-1/8	x2-5/8	x1/4	2.100	.018	53.34	0.46
-407***				2-1/4	x2-3/4	x1/4	2.225	.018	56.52	0.46
-408***				2-3/8	x2-7/8	x1/4	2.350	.018	59.69	0.46
-409***				2-1/2	x3	x1/4	2.475	.018	62.87	0.46
-410***				2-5/8	x3-1/8	x1/4	2.600	.018	66.04	0.46
-411***				2-3/4	x3-1/4	x1/4	2.725	.022	69.22	0.56
-412***				2-7/8	x3-3/8	x1/4	2.850	.022	72.39	0.56
-413***				3	x3-1/2	x1/4	2.975	.024	75.57	0.61
-414***				3-1/8	x3-5/8	x1/4	3.100	.024	78.74	0.61
-415***				3-1/4	x3-3/4	x1/4	3.225	.024	81.92	0.61
-416***				3-3/8	x3-7/8	x1/4	3.350	.026	85.09	0.66
-417***				3-1/2	x4	x1/4	3.475	.026	88.27	0.66
-418***				3-5/8	x4-1/8	x1/4	3.600	.026	91.44	0.66
-419***				3-3/4	x4-1/4	x1/4	3.725	.028	94.62	0.71
-420***				3-7/8	x4-3/8	x1/4	3.850	.028	97.79	0.71
-421***				4	x4-1/2	x1/4	3.975	.028	100.97	0.71
-422***				4-1/8	x4-5/8	x1/4	4.100	.030	104.14	0.76
-423***				4-1/4	x4-3/4	x1/4	4.225	.030	107.32	0.76
-424***				4-3/8	x4-7/8	x1/4	4.350	.030	110.49	0.76
-425 to -475 Cross Section Diameters = .275 ± .006 inches — 6.99 ± 0.15 millimeters.										
-425	AN 6227B-88	-425		4-1/2	x5	x1/4	4.475	.033	113.67	0.84
-426	AN 6227B-53	-426		4-5/8	x5-1/8	x1/4	4.600	.033	116.84	0.84
-427	AN 6227B-54	-427		4-3/4	x5-1/4	x1/4	4.725	.033	120.02	0.84
-428	AN 6227B-55	-428		4-7/8	x5-3/8	x1/4	4.850	.033	123.19	0.84
-429	AN 6227B-56	-429		5	x5-1/2	x1/4	4.975	.037	126.37	0.94
-430	AN 6227B-57	-430		5-1/8	x5-5/8	x1/4	5.100	.037	129.54	0.94
-431	AN 6227B-58	-431		5-1/4	x5-3/4	x1/4	5.225	.037	132.72	0.94
-432	AN 6227B-59	-432		5-3/8	x5-7/8	x1/4	5.350	.037	135.89	0.94
-433	AN 6227B-60	-433		5-1/2	x6	x1/4	5.475	.037	139.07	0.94
-434	AN 6227B-61	-434		5-5/8	x6-1/8	x1/4	5.600	.037	142.24	0.94
-435	AN 6227B-62	-435		5-3/4	x6-1/4	x1/4	5.725	.037	145.42	0.94
-436	AN 6227B-63	-436		5-7/8	x6-3/8	x1/4	5.850	.037	148.59	0.94
-437	AN 6227B-64	-437		6	x6-1/2	x1/4	5.975	.037	151.77	0.94
-438	AN 6227B-65	-438		6-1/4	x6-3/4	x1/4	6.225	.040	158.12	1.02
-439	AN 6227B-66	-439		6-1/2	x7	x1/4	6.475	.040	164.47	1.02
-440	AN 6227B-67	-440		6-3/4	x7-1/4	x1/4	6.725	.040	170.82	1.02
-441	AN 6227B-68	-441		7	x7-1/2	x1/4	6.975	.040	177.17	1.02
-442	AN 6227B-69	-442		7-1/4	x7-3/4	x1/4	7.225	.045	183.52	1.14
-443	AN 6227B-70	-443		7-1/2	x8	x1/4	7.475	.045	189.87	1.14
-444	AN 6227B-71	-444		7-3/4	x8-1/4	x1/4	7.725	.045	196.22	1.14
-445	AN 6227B-72	-445		8	x8-1/2	x1/4	7.975	.045	202.57	1.14

¹ For AN 123956 to AN 124034, add 100 to part numbers shown in this column.

*** Dash numbers 400-424 are not listed on AS 568A, but are stock items at American Packing in selected compounds.

NOTES: (1) "AN", "MS", and "NAS" information is for size cross-reference only. "AN", "MS", and "NAS" O-Rings require special compounds. APG O-Rings are available in a variety of compounds.

(2) Actual dimensions for standard (AN) shrinkage materials only. These correspond to AS568A dimensions. O-Rings manufactured out of compounds with different shrinkage rates (other than AN) will produce slightly different dimensions and tolerances.

Standard O-Ring Sizes and Dimensions (Continued)

AS-568A UNIVERSAL DASH NUMBERS	AN 6227B AND AN 6230B PART NUMBERS	MS 28775 MS 29513 MS 29561 MS 9021 MS 9068 NAS 1593 NAS 1594 NAS 1611 DASH NUMBERS	AN 123856 ¹ TO AN 123934 PART NUMBERS	NOMINAL SIZE			INCH STANDARD		METRIC STANDARD (MM)	
				I.D.	O.D.	C.S.	I.D.	±	I.D.	±
-425 to -475 Cross Section Diameters = .275 ± .006 inches — 6.99 ± 0.15 millimeters.										
-446	AN 6227B-73	-446		8-1/2	x9	x1/4	8.475	.055	215.27	1.40
-447	AN 6227B-74	-447		9	x9-1/2	x1/4	8.975	.055	227.97	1.40
-448	AN 6227B-75	-448		9-1/2	x10	x1/4	9.475	.055	240.67	1.40
-449	AN 6227B-76	-449		10	x10-1/2	x1/4	9.975	.055	253.37	1.40
-450	AN 6227B-77	-450		10-1/2	x11	x1/4	10.475	.060	266.07	1.52
-451	AN 6227B-78	-451		11	x11-1/2	x1/4	10.975	.060	278.77	1.52
-452	AN 6227B-79	-452		11-1/2	x12	x1/4	11.475	.060	291.47	1.52
-453	AN 6227B-80	-453		12	x12-1/2	x1/4	11.975	.060	304.17	1.52
-454	AN 6227B-81	-454		12-1/2	x13	x1/4	12.475	.060	316.87	1.52
-455	AN 6227B-82	-455		13	x13-1/2	x1/4	12.975	.060	329.57	1.52
-456	AN 6227B-83	-456		13-1/2	x14	x1/4	13.475	.070	342.27	1.78
-457	AN 6227B-84	-457		14	x14-1/2	x1/4	13.975	.070	354.97	1.78
-458	AN 6227B-85	-458		14-1/2	x15	x1/4	14.475	.070	367.67	1.78
-459	AN 6227B-86	-459		15	x15-1/2	x1/4	14.975	.070	380.37	1.78
-460	AN 6227B-87	-460		15-1/2	x16	x1/4	15.475	.070	393.07	1.78
-461		-461*††		16	x16-1/2	x1/4	15.955	.075	405.26	1.90
-462		-462*††		16-1/2	x17	x1/4	16.455	.075	417.96	1.90
-463		-463*††		17	x17-1/2	x1/4	16.955	.080	430.66	2.03
-464		-464*††		17-1/2	x18	x1/4	17.455	.085	443.36	2.15
-465		-465*††		18	x18-1/2	x1/4	17.955	.085	456.06	2.15
-466		-466*††		18-1/2	x19	x1/4	18.455	.085	468.76	2.15
-467		-467*††		19	x19-1/2	x1/4	18.955	.090	481.46	2.29
-468		-468*††		19-1/2	x20	x1/4	19.455	.090	494.16	2.29
-469		-469*††		20	x20-1/2	x1/4	19.955	.095	506.86	2.41
-470		-470*††		21	x21-1/2	x1/4	20.955	.095	532.26	2.41
-471		-471*††		22	x22-1/2	x1/4	21.955	.100	557.66	2.55
-472		-472*††		23	x23-1/2	x1/4	22.940	.105	582.68	2.67
-473		-473*††		24	x24-1/2	x1/4	23.940	.110	608.08	2.79
-474		-474*††		25	x25-1/2	x1/4	24.940	.115	633.48	2.92
-475		-475*††		26	x26-1/2	x1/4	25.940	.120	658.88	3.05

¹ For AN 123956 to AN 124034, add 100 to part numbers shown in this column.
 * These dash numbers are not included in MS 28775, MS 29561 or NAS 1611 series.
 †† These dash numbers are not included in MS 9068, NAS 1593 or NAS 1594.

NOTES: (1) "AN", "MS", and "NAS" information is for size cross-reference only. "AN", "MS", and "NAS" O-Rings require special compounds. APG O-Rings are available in a variety of compounds.
 (2) Actual dimensions for standard (AN) shrinkage materials only. These correspond to AS568A dimensions. O-Rings manufactured out of compounds with different shrinkage rates (other than AN) will produce slightly different dimensions and tolerances.

*Dash Number Cross-References

AN 6227 / AS 568A									
AN 6227	AS 568A	AN 6227	AS 568A	AN 6227	AS 568A	AN 6227	AS 568A	AN 6227	AS 568A
1	006	19	214	37	334	55	428	73	446
2	007	20	215	38	335	56	429	74	447
3	008	21	216	39	336	57	430	75	448
4	009	22	217	40	337	58	431	76	449
5	010	23	218	41	338	59	432	77	450
6	011	24	219	42	339	60	433	78	451
7	012	25	220	43	340	61	434	79	452
8	110	26	221	44	341	62	435	80	453
9	111	27	222	45	342	63	436	81	454
10	112	28	325	46	343	64	437	82	455
11	113	29	326	47	344	65	438	83	456
12	114	30	327	48	345	66	439	84	457
13	115	31	328	49	346	67	440	85	458
14	116	32	329	50	347	68	441	86	459
15	210	33	330	51	348	69	442	87	460
16	211	34	331	52	349	70	443	88	425
17	212	35	332	53	426	71	444		
18	213	36	333	54	427	72	445		

AN 6230 / AS 568A									
AN 6230	AS 568A	AN 6230	AS 568A	AN 6230	AS 568A	AN 6230	AS 568A	AN 6230	AS 568A
1	223	12	234	23	245	34	256	45	267
2	224	13	235	24	246	35	257	46	268
3	225	14	236	25	247	36	258	47	269
4	226	15	237	26	248	37	259	48	270
5	227	16	238	27	249	38	260	49	271
6	228	17	239	28	250	39	261	50	272
7	229	18	240	29	251	40	262	51	273
8	230	19	241	30	252	41	263	52	274
9	231	20	242	31	253	42	264		
10	232	21	243	32	254	43	265		
11	233	22	244	33	255	44	266		

*These charts are for size cross-reference only. "AN" O-Rings require special compounds. APG O-Rings are available in a variety of compounds.

O-Ring Boss Gaskets For Straight Thread Tube Fittings

AS 568A DASH NUMBERS	NAS 1595 NAS 1596	MS 9020 MS 29512	TUBE SIZE O.D. INCHES	INCH STANDARD		METRIC STANDARD		INCH STANDARD		METRIC STANDARD	
	MS 28778 NAS 617 NAS 1612			INSIDE DIAMETER		INSIDE DIAMETER		CROSS- SECTION		CROSS- SECTION	
	DASH NUMBERS	DASH NUMBERS		IN.	±	MM	±	IN.	±	MM	±
-901		-01	3/32	.185	.005	4.70	.13	.056	.003	1.42	.08
-902	-2	-02	1/8	.239	.005	6.07	.13	.064	.003	1.63	.08
-903	-3	-03	3/16	.301	.005	7.65	.13	.064	.003	1.63	.08
-904	-4	-04	1/4	.351	.005	8.92	.13	.072	.003	1.83	.08
-905	-5	-05	5/16	.414	.005	10.52	.13	.072	.003	1.83	.08
-906	-6	-06	3/8	.468	.005	11.89	.13	.078	.003	1.98	.08
-907		-07	7/16	.530	.007	13.46	.18	.082	.003	2.08	.08
-908	-8	-08	1/2	.644	.009	16.36	.23	.087	.003	2.21	.08
-909		-09	9/16	.706	.009	17.93	.23	.097	.003	2.46	.08
-910	-10	-10	5/8	.755	.009	19.18	.23	.097	.003	2.46	.08
-911		-11	11/16	.863	.009	21.92	.23	.116	.004	2.95	.10
-912	-12	-12	3/4	.924	.009	23.47	.23	.116	.004	2.95	.10
-913		-13	13/16	.986	.010	25.04	.25	.116	.004	2.95	.10
-914		-14	7/8	1.047	.010	26.59	.25	.116	.004	2.95	.10
-916	-16	-16	1	1.171	.010	29.74	.25	.116	.004	2.95	.10
-918		-18	1-1/8	1.355	.012	34.42	.30	.116	.004	2.95	.10
-920	-20	-20	1-1/4	1.475	.014	37.47	.36	.118	.004	3.00	.10
-924	-24	-24	1-1/2	1.720	.014	43.69	.36	.118	.004	3.00	.10
-928	-28	-28	1-3/4	2.090	.018	53.09	.46	.118	.004	3.00	.10
-932	-32	-32	2	2.337	.018	59.36	.46	.118	.004	3.00	.10

NOTE: "NAS" and "MS" information is for size cross-reference only. "NAS" and "MS" O-Rings require special compounds. APG O-Rings are available in a variety of compounds.

Metric O-Rings *

*The following listing of metric O-Ring sizes includes cross reference information for American Standard (AS 568A) O-Ring sizes, Japanese Metric O-Rings, and British Standard Metric O-Rings. AS 568A dash numbers are shaded; G, P, S, and V numbers are Japanese Metric O-Rings; and BS numbers are British Standard Metric O-Rings. This is a comprehensive listing, and APG stocks most of the sizes. Some sizes, however, are not commonly used and are not standard stock items. Call for availability.

(Metric O-Ring Tolerances – Page 40)

CROSS SECTION (mm)	INSIDE DIAMETER (mm)	SIZE CROSS REF.
0.70 X	1.80	
0.80 X	22.80	
0.81 X	5.36	
0.84 X	6.10	
0.90 X	22.80	
0.97 X	2.54	
1.00 X	1.15	
1.00 X	1.25	
1.00 X	1.50	
1.00 X	1.80	
1.00 X	2.00	
1.00 X	2.50	
1.00 X	2.70	
1.00 X	3.00	
1.00 X	3.30	
1.00 X	3.50	
1.00 X	4.00	
1.00 X	4.50	
1.00 X	5.00	
1.00 X	5.50	
1.00 X	6.00	
1.00 X	6.50	
1.00 X	7.00	
1.00 X	7.20	
1.00 X	7.50	
1.00 X	8.00	
1.00 X	8.50	
1.00 X	9.00	
1.00 X	9.50	
1.00 X	10.00	
1.00 X	10.50	
1.00 X	11.00	
1.00 X	11.50	
1.00 X	12.00	
1.00 X	12.50	
1.00 X	13.00	
1.00 X	13.50	
1.00 X	14.00	
1.00 X	14.50	
1.00 X	15.00	
1.00 X	15.50	
1.00 X	16.00	
1.00 X	16.50	
1.00 X	17.00	
1.00 X	17.50	
1.00 X	18.00	
1.00 X	18.50	
1.00 X	19.00	
1.00 X	19.50	
1.00 X	20.00	
1.00 X	20.50	
1.00 X	21.00	

CROSS SECTION (mm)	INSIDE DIAMETER (mm)	SIZE CROSS REF.
1.00 X	21.50	
1.00 X	22.00	
1.00 X	22.50	
1.00 X	23.00	
1.00 X	23.50	
1.00 X	24.00	
1.00 X	24.50	
1.00 X	25.00	
1.00 X	28.00	
1.00 X	29.40	
1.00 X	29.90	
1.00 X	30.50	
1.00 X	31.80	
1.00 X	32.00	
1.00 X	39.00	
1.00 X	42.00	
1.00 X	60.00	
1.02 X	.74	-001
1.02 X	1.78	-001-1/2BS606
1.02 X	2.54	BS607
1.15 X	42.10	
1.19 X	4.32	
1.20 X	2.50	
1.20 X	2.60	
1.20 X	3.50	
1.20 X	5.00	
1.20 X	24.00	
1.20 X	26.00	
1.20 X	28.00	
1.20 X	35.00	
1.20 X	40.00	
1.20 X	53.50	
1.20 X	98.00	
1.25 X	3.80	
1.25 X	8.00	
1.25 X	16.00	
1.27 X	1.07	-002
1.27 X	3.25	
1.27 X	3.91	
1.27 X	4.47	
1.30 X	2.50	
1.30 X	8.00	
1.30 X	10.00	
1.30 X	11.00	
1.30 X	13.50	
1.30 X	20.00	

CROSS SECTION (mm)	INSIDE DIAMETER (mm)	SIZE CROSS REF.
1.42 X	4.70	-901
1.50 X	1.80	
1.50 X	1.85	
1.50 X	2.00	
1.50 X	2.50	S3
1.50 X	2.80	
1.50 X	3.00	
1.50 X	3.50	S4
1.50 X	4.00	
1.50 X	4.50	S5
1.50 X	5.00	
1.50 X	5.50	S6
1.50 X	6.00	
1.50 X	6.50	S7
1.50 X	7.00	
1.50 X	7.50	S8
1.50 X	8.00	
1.50 X	8.50	S9
1.50 X	9.00	
1.50 X	9.50	S10
1.50 X	10.00	
1.50 X	10.50	
1.50 X	10.70	S11.2
1.50 X	11.00	
1.50 X	11.50	S12
1.50 X	12.00	S12.5
1.50 X	12.50	
1.50 X	13.00	
1.50 X	13.25	
1.50 X	13.50	S14
1.50 X	14.00	
1.50 X	14.50	S15
1.50 X	15.00	
1.50 X	15.50	S16
1.50 X	16.00	
1.50 X	16.50	
1.50 X	17.00	
1.50 X	17.50	S18
1.50 X	18.00	
1.50 X	18.50	
1.50 X	19.00	
1.50 X	19.50	S20
1.50 X	20.00	
1.50 X	20.50	
1.50 X	21.00	
1.50 X	21.50	S22
1.50 X	22.00	
1.50 X	22.50	
1.50 X	23.00	
1.50 X	23.50	
1.50 X	24.00	
1.50 X	24.50	

CROSS SECTION (mm)	INSIDE DIAMETER (mm)	SIZE CROSS REF.
1.50 X	25.00	
1.50 X	25.50	
1.50 X	26.00	
1.50 X	26.50	
1.50 X	27.00	
1.50 X	27.50	
1.50 X	28.00	
1.50 X	28.50	
1.50 X	29.00	
1.50 X	29.50	
1.50 X	30.00	
1.50 X	30.50	
1.50 X	31.00	
1.50 X	31.50	
1.50 X	32.00	
1.50 X	32.50	
1.50 X	33.00	
1.50 X	33.50	
1.50 X	34.00	
1.50 X	34.50	
1.50 X	35.00	
1.50 X	35.50	
1.50 X	36.00	
1.50 X	36.50	
1.50 X	37.00	
1.50 X	37.50	
1.50 X	38.00	
1.50 X	38.50	
1.50 X	39.00	
1.50 X	39.50	
1.50 X	40.00	
1.50 X	41.00	
1.50 X	42.00	
1.50 X	43.00	
1.50 X	44.00	
1.50 X	45.00	
1.50 X	46.00	
1.50 X	47.00	
1.50 X	48.00	
1.50 X	49.00	
1.50 X	50.00	
1.50 X	51.00	
1.50 X	52.00	
1.50 X	53.00	
1.50 X	54.00	
1.50 X	55.00	
1.50 X	56.00	
1.50 X	57.00	
1.50 X	58.00	
1.50 X	59.00	
1.50 X	60.00	
1.50 X	61.00	
1.50 X	62.00	

Metric O-Rings (Continued)

(Metric O-Ring Tolerances – Page 40)

CROSS SECTION (mm)	INSIDE DIAMETER (mm)	SIZE CROSS REF.
1.50 X	63.00	
1.50 X	64.00	
1.50 X	65.00	
1.50 X	66.00	
1.50 X	67.00	
1.50 X	68.00	
1.50 X	69.00	
1.50 X	70.00	
1.50 X	71.00	
1.50 X	72.00	
1.50 X	73.00	
1.50 X	74.00	
1.50 X	75.00	
1.50 X	76.00	
1.50 X	77.00	
1.50 X	78.00	
1.50 X	79.00	
1.50 X	80.00	
1.50 X	81.00	
1.50 X	82.00	
1.50 X	83.00	
1.50 X	84.00	
1.50 X	85.00	
1.50 X	86.00	
1.50 X	87.00	
1.50 X	88.00	
1.50 X	89.00	
1.50 X	90.00	
1.50 X	91.00	
1.50 X	92.00	
1.50 X	93.00	
1.50 X	94.00	
1.50 X	95.00	
1.50 X	96.00	
1.50 X	97.00	
1.50 X	98.00	
1.50 X	99.00	
1.50 X	100.00	
1.52 X	1.42	-003
1.60 X	2.20	
1.60 X	2.75	
1.60 X	2.80	
1.60 X	3.10	
1.60 X	3.20	
1.60 X	3.70	
1.60 X	4.10	
1.60 X	4.70	
1.60 X	5.00	
1.60 X	5.10	
1.60 X	6.10	
1.60 X	7.10	

CROSS SECTION (mm)	INSIDE DIAMETER (mm)	SIZE CROSS REF.
1.60 X	8.10	
1.60 X	9.10	
1.60 X	10.10	
1.60 X	11.10	
1.60 X	12.10	
1.60 X	13.10	
1.60 X	14.10	
1.60 X	15.10	
1.60 X	16.10	
1.60 X	17.10	
1.60 X	18.10	
1.60 X	19.10	
1.60 X	20.30	
1.60 X	21.10	
1.60 X	22.10	
1.60 X	25.10	
1.60 X	27.10	
1.60 X	29.10	
1.60 X	32.10	
1.60 X	35.10	
1.60 X	37.10	
1.60 X	51.10	
1.60 X	86.00	
1.60 X	96.60	
1.60 X	115.00	
1.63 X	6.07	-902
1.63 X	7.65	-903
1.78 X	1.78	-004
1.78 X	2.57	-005
1.78 X	2.90	-006
1.78 X	3.17	BS801
1.78 X	3.68	-007
1.78 X	4.47	-008
1.78 X	4.76	BS802
1.78 X	5.28	-009
1.78 X	6.07	-010
1.78 X	6.35	BS803
1.78 X	6.75	BS610
1.78 X	7.65	-011
1.78 X	7.94	BS804
1.78 X	8.73	BS611
1.78 X	9.25	-012
1.78 X	9.52	
1.78 X	10.82	-013
1.78 X	11.11	BS806
1.78 X	11.91	
1.78 X	12.42	-014
1.78 X	14.00	-015
1.78 X	15.60	-016
1.78 X	17.17	-017
1.78 X	18.77	-018

CROSS SECTION (mm)	INSIDE DIAMETER (mm)	SIZE CROSS REF.
1.78 X	19.05	
1.78 X	19.15	
1.78 X	20.35	-019
1.78 X	21.47	
1.78 X	21.95	-020
1.78 X	23.52	-021
1.78 X	25.12	-022
1.78 X	26.70	-023
1.78 X	28.30	-024
1.78 X	29.87	-025
1.78 X	31.47	-026
1.78 X	33.05	-027
1.78 X	34.65	-028
1.78 X	36.00	
1.78 X	36.27	BS517
1.78 X	37.82	-029
1.78 X	39.45	BS519
1.78 X	41.00	-030
1.78 X	44.17	-031
1.78 X	45.84	
1.78 X	47.35	-032
1.78 X	50.52	-033
1.78 X	53.70	-034
1.78 X	56.87	-035
1.78 X	60.05	-036
1.78 X	63.22	-037
1.78 X	66.40	-038
1.78 X	69.57	-039
1.78 X	72.75	-040
1.78 X	75.92	-041
1.78 X	79.00	BS532
1.78 X	82.27	-042
1.78 X	85.34	BS534
1.78 X	88.62	-043
1.78 X	91.70	BS536
1.78 X	94.97	-044
1.78 X	98.05	BS538
1.78 X	101.32	-045
1.78 X	104.40	BS540
1.78 X	107.67	-046
1.78 X	110.74	BS542
1.78 X	114.02	-047
1.78 X	117.10	BS544
1.78 X	120.37	-048
1.78 X	123.44	BS546
1.78 X	126.72	-049
1.78 X	129.40	BS548
1.78 X	133.07	-050
1.78 X	135.76	BS550
1.78 X	138.94	BS551
1.78 X	142.11	BS552
1.78 X	145.29	BS553
1.78 X	148.46	BS554

CROSS SECTION (mm)	INSIDE DIAMETER (mm)	SIZE CROSS REF.
1.78 X	151.64	BS555
1.78 X	154.81	BS556
1.78 X	158.00	BS557
1.78 X	161.16	BS558
1.78 X	164.34	BS559
1.78 X	167.51	BS560
1.78 X	170.69	BS561
1.78 X	173.87	BS562
1.80 X	1.80	
1.80 X	2.00	
1.80 X	2.24	
1.80 X	2.50	
1.80 X	2.80	
1.80 X	3.15	
1.80 X	3.55	
1.80 X	3.75	
1.80 X	4.00	
1.80 X	4.50	
1.80 X	4.87	
1.80 X	5.00	
1.80 X	5.15	
1.80 X	5.30	
1.80 X	5.60	
1.80 X	6.00	
1.80 X	6.30	
1.80 X	6.70	
1.80 X	6.90	
1.80 X	7.10	
1.80 X	7.50	
1.80 X	8.00	
1.80 X	8.50	
1.80 X	8.76	
1.80 X	9.00	
1.80 X	9.50	
1.80 X	10.00	
1.80 X	10.60	
1.80 X	11.20	
1.80 X	11.80	
1.80 X	12.50	
1.80 X	13.20	
1.80 X	14.00	
1.80 X	15.00	
1.80 X	16.00	
1.80 X	17.00	
1.83 X	8.92	-904
1.83 X	10.52	-905
1.90 X	2.40	
1.90 X	2.60	
1.90 X	2.80	P3
1.90 X	3.40	

Metric O-Rings (Continued)

(Metric O-Ring Tolerances – Page 40)

CROSS SECTION (mm)	INSIDE DIAMETER (mm)	SIZE CROSS REF.
1.90 X	3.70	
1.90 X	3.80	P4
1.90 X	4.20	
1.90 X	4.80	P5
1.90 X	4.90	
1.90 X	5.70	
1.90 X	5.80	P6
1.90 X	6.40	
1.90 X	6.80	P7
1.90 X	7.20	
1.90 X	7.80	P8
1.90 X	8.00	
1.90 X	8.80	P9
1.90 X	8.90	
1.90 X	9.80	P10
1.92 X	67.10	
1.98 X	11.89	-906
2.00 X	2.00	
2.00 X	2.50	
2.00 X	2.60	
2.00 X	3.00	
2.00 X	3.50	
2.00 X	4.00	
2.00 X	4.50	
2.00 X	4.60	
2.00 X	5.00	
2.00 X	5.50	
2.00 X	6.00	
2.00 X	6.50	
2.00 X	7.00	
2.00 X	7.50	
2.00 X	8.00	
2.00 X	8.50	
2.00 X	9.00	
2.00 X	9.50	
2.00 X	10.00	
2.00 X	10.50	
2.00 X	11.00	
2.00 X	11.50	
2.00 X	12.00	
2.00 X	12.50	
2.00 X	13.00	
2.00 X	13.50	
2.00 X	14.00	
2.00 X	14.50	
2.00 X	15.00	
2.00 X	15.50	
2.00 X	16.00	
2.00 X	16.50	
2.00 X	17.00	

CROSS SECTION (mm)	INSIDE DIAMETER (mm)	SIZE CROSS REF.
2.00 X	17.50	
2.00 X	18.00	
2.00 X	18.50	
2.00 X	19.00	
2.00 X	19.50	
2.00 X	20.00	
2.00 X	20.50	
2.00 X	21.00	
2.00 X	21.50	
2.00 X	21.90	S22.4
2.00 X	22.00	
2.00 X	22.50	
2.00 X	23.00	
2.00 X	23.50	S24
2.00 X	24.00	
2.00 X	24.50	S25
2.00 X	25.00	
2.00 X	25.50	S26
2.00 X	26.00	
2.00 X	26.50	
2.00 X	27.00	
2.00 X	27.50	S28
2.00 X	28.00	
2.00 X	28.50	S29
2.00 X	29.00	
2.00 X	29.50	S30
2.00 X	30.00	
2.00 X	30.50	
2.00 X	31.00	S31.5
2.00 X	31.50	S32
2.00 X	32.00	
2.00 X	32.50	
2.00 X	33.00	
2.00 X	33.50	S34
2.00 X	34.00	
2.00 X	34.50	S35
2.00 X	35.00	S35.5
2.00 X	35.50	S36
2.00 X	36.00	
2.00 X	36.50	
2.00 X	37.00	
2.00 X	37.50	S38
2.00 X	38.00	
2.00 X	38.50	S39
2.00 X	39.00	
2.00 X	39.50	S40
2.00 X	40.00	
2.00 X	41.00	
2.00 X	41.50	S42
2.00 X	42.00	
2.00 X	42.50	S43
2.00 X	43.00	
2.00 X	43.50	S44

CROSS SECTION (mm)	INSIDE DIAMETER (mm)	SIZE CROSS REF.
2.00 X	44.00	
2.00 X	44.50	S45
2.00 X	45.00	
2.00 X	45.50	S46
2.00 X	46.00	
2.00 X	47.00	
2.00 X	47.50	S48
2.00 X	48.00	
2.00 X	49.00	
2.00 X	49.50	S50
2.00 X	50.00	
2.00 X	51.00	
2.00 X	52.00	
2.00 X	52.50	S53
2.00 X	53.00	
2.00 X	54.00	
2.00 X	54.50	S55
2.00 X	55.00	
2.00 X	55.50	S56
2.00 X	56.00	
2.00 X	57.00	
2.00 X	58.00	
2.00 X	59.00	
2.00 X	59.50	S60
2.00 X	60.00	
2.00 X	61.00	
2.00 X	62.00	
2.00 X	62.50	S63
2.00 X	63.00	
2.00 X	64.00	
2.00 X	64.50	S65
2.00 X	65.00	
2.00 X	66.00	
2.00 X	66.50	S67
2.00 X	67.00	
2.00 X	68.00	
2.00 X	69.00	
2.00 X	69.50	S70
2.00 X	70.00	
2.00 X	70.50	S71
2.00 X	71.00	
2.00 X	72.00	
2.00 X	73.00	
2.00 X	74.00	
2.00 X	74.50	S75
2.00 X	75.00	
2.00 X	76.00	
2.00 X	77.00	
2.00 X	78.00	
2.00 X	79.00	
2.00 X	79.50	S80
2.00 X	80.00	
2.00 X	81.00	

CROSS SECTION (mm)	INSIDE DIAMETER (mm)	SIZE CROSS REF.
2.00 X	82.00	
2.00 X	83.00	
2.00 X	84.00	
2.00 X	84.50	S85
2.00 X	85.00	
2.00 X	86.00	
2.00 X	87.00	
2.00 X	88.00	
2.00 X	89.00	
2.00 X	89.50	S90
2.00 X	90.00	
2.00 X	91.00	
2.00 X	92.00	
2.00 X	93.00	
2.00 X	94.00	
2.00 X	94.50	S95
2.00 X	95.00	
2.00 X	96.00	
2.00 X	97.00	
2.00 X	98.00	
2.00 X	99.00	
2.00 X	99.50	S100
2.00 X	100.00	
2.00 X	102.00	
2.00 X	104.50	S105
2.00 X	105.00	
2.00 X	109.00	
2.00 X	109.50	S110
2.00 X	110.00	
2.00 X	111.50	S112
2.00 X	114.50	S115
2.00 X	115.00	
2.00 X	119.50	S120
2.00 X	120.00	
2.00 X	124.50	S125
2.00 X	125.60	
2.00 X	129.50	S130
2.00 X	130.00	
2.00 X	131.50	S132
2.00 X	134.50	S135
2.00 X	139.50	S140
2.00 X	140.00	
2.00 X	144.50	S145
2.00 X	149.50	S150
2.00 X	165.00	
2.00 X	180.00	
2.00 X	194.00	
2.08 X	13.46	-907
2.18 X	12.40	
2.20 X	6.00	

Metric O-Rings (Continued)

(Metric O-Ring Tolerances – Page 40)

CROSS SECTION (mm)	INSIDE DIAMETER (mm)	SIZE CROSS REF.
2.20 X	9.00	
2.20 X	10.00	
2.20 X	18.00	
2.21 X	16.36	-908
2.40 X	3.30	
2.40 X	3.60	
2.40 X	4.30	
2.40 X	4.60	
2.40 X	5.30	
2.40 X	5.50	
2.40 X	5.60	
2.40 X	6.30	
2.40 X	6.60	
2.40 X	7.30	
2.40 X	7.50	
2.40 X	7.60	
2.40 X	8.00	
2.40 X	8.30	
2.40 X	8.60	
2.40 X	9.30	
2.40 X	9.60	
2.40 X	9.80	P10A
2.40 X	10.30	
2.40 X	10.50	
2.40 X	10.60	
2.40 X	10.80	P11
2.40 X	11.00	P11.2
2.40 X	11.30	
2.40 X	11.50	
2.40 X	11.60	
2.40 X	11.80	P12
2.40 X	12.30	P12.5
2.40 X	12.60	
2.40 X	13.30	
2.40 X	13.50	
2.40 X	13.60	
2.40 X	13.80	P14
2.40 X	14.30	
2.40 X	14.50	
2.40 X	14.60	
2.40 X	14.80	P15
2.40 X	15.30	
2.40 X	15.50	
2.40 X	15.60	
2.40 X	15.80	P16
2.40 X	15.90	
2.40 X	16.30	
2.40 X	16.60	
2.40 X	17.30	
2.40 X	17.50	
2.40 X	17.60	

CROSS SECTION (mm)	INSIDE DIAMETER (mm)	SIZE CROSS REF.
2.40 X	17.80	P18
2.40 X	18.30	
2.40 X	18.60	
2.40 X	19.30	
2.40 X	19.60	
2.40 X	19.80	P20
2.40 X	20.30	
2.40 X	20.50	
2.40 X	20.80	P21
2.40 X	21.30	
2.40 X	21.50	
2.40 X	21.60	
2.40 X	21.80	P22
2.40 X	22.30	
2.40 X	22.60	
2.40 X	23.30	
2.40 X	23.50	
2.40 X	23.60	
2.40 X	24.30	
2.40 X	24.50	
2.40 X	24.60	
2.40 X	25.00	
2.40 X	25.30	
2.40 X	25.60	
2.40 X	27.30	
2.40 X	27.50	
2.40 X	27.60	
2.40 X	29.60	
2.40 X	30.30	
2.40 X	31.60	
2.40 X	33.30	
2.40 X	34.60	
2.40 X	36.50	
2.40 X	37.60	
2.40 X	39.60	
2.40 X	41.60	
2.40 X	44.60	
2.40 X	47.60	
2.40 X	49.60	
2.40 X	51.60	
2.40 X	54.60	
2.40 X	57.60	
2.40 X	59.60	
2.40 X	61.60	
2.40 X	64.60	
2.40 X	67.60	
2.40 X	69.60	
2.40 X	161.60	
2.46 X	17.93	-909
2.46 X	19.18	-910
2.50 X	4.00	

CROSS SECTION (mm)	INSIDE DIAMETER (mm)	SIZE CROSS REF.
2.50 X	4.60	
2.50 X	5.00	
2.50 X	5.50	
2.50 X	6.00	
2.50 X	6.50	
2.50 X	7.00	
2.50 X	7.50	
2.50 X	8.00	
2.50 X	8.50	
2.50 X	9.00	
2.50 X	9.50	
2.50 X	10.00	
2.50 X	10.50	
2.50 X	11.00	
2.50 X	11.50	
2.50 X	12.00	
2.50 X	12.50	
2.50 X	13.00	
2.50 X	13.50	
2.50 X	14.00	
2.50 X	14.50	
2.50 X	15.00	
2.50 X	15.50	
2.50 X	16.00	
2.50 X	16.50	
2.50 X	17.00	
2.50 X	17.50	
2.50 X	18.00	
2.50 X	18.50	
2.50 X	19.00	
2.50 X	19.50	
2.50 X	20.00	
2.50 X	20.50	
2.50 X	21.00	
2.50 X	21.50	
2.50 X	22.00	
2.50 X	22.50	
2.50 X	23.00	
2.50 X	23.50	
2.50 X	24.00	
2.50 X	24.50	
2.50 X	25.00	
2.50 X	25.50	
2.50 X	26.00	
2.50 X	26.50	
2.50 X	27.00	
2.50 X	27.50	
2.50 X	28.00	
2.50 X	28.50	
2.50 X	29.00	
2.50 X	29.50	
2.50 X	30.00	
2.50 X	30.50	

CROSS SECTION (mm)	INSIDE DIAMETER (mm)	SIZE CROSS REF.
2.50 X	31.00	
2.50 X	31.50	
2.50 X	32.00	
2.50 X	32.50	
2.50 X	33.00	
2.50 X	33.50	
2.50 X	34.00	
2.50 X	34.50	
2.50 X	35.00	
2.50 X	35.50	
2.50 X	36.00	
2.50 X	36.50	
2.50 X	37.00	
2.50 X	37.50	
2.50 X	38.00	
2.50 X	38.50	
2.50 X	39.00	
2.50 X	39.50	
2.50 X	40.00	
2.50 X	41.00	
2.50 X	42.00	
2.50 X	43.00	
2.50 X	44.00	
2.50 X	45.00	
2.50 X	46.00	
2.50 X	47.00	
2.50 X	48.00	
2.50 X	49.00	
2.50 X	50.00	
2.50 X	51.00	
2.50 X	52.00	
2.50 X	53.00	
2.50 X	54.00	
2.50 X	55.00	
2.50 X	56.00	
2.50 X	57.00	
2.50 X	58.00	
2.50 X	59.00	
2.50 X	60.00	
2.50 X	61.00	
2.50 X	62.00	
2.50 X	63.00	
2.50 X	64.00	
2.50 X	65.00	
2.50 X	66.00	
2.50 X	67.00	
2.50 X	68.00	
2.50 X	69.00	
2.50 X	70.00	
2.50 X	71.00	
2.50 X	72.00	
2.50 X	73.00	
2.50 X	74.00	

Metric O-Rings (Continued)

(Metric O-Ring Tolerances – Page 40)

CROSS SECTION (mm)	INSIDE DIAMETER (mm)	SIZE CROSS REF.
2.50 X	75.00	
2.50 X	76.00	
2.50 X	77.00	
2.50 X	78.00	
2.50 X	79.00	
2.50 X	80.00	
2.50 X	81.00	
2.50 X	82.00	
2.50 X	83.00	
2.50 X	84.00	
2.50 X	85.00	
2.50 X	86.00	
2.50 X	87.00	
2.50 X	88.00	
2.50 X	89.00	
2.50 X	90.00	
2.50 X	91.00	
2.50 X	92.00	
2.50 X	93.00	
2.50 X	94.00	
2.50 X	95.00	
2.50 X	96.00	
2.50 X	97.00	
2.50 X	98.00	
2.50 X	99.00	
2.50 X	100.00	
2.50 X	101.00	
2.50 X	102.00	
2.50 X	103.00	
2.50 X	104.00	
2.50 X	105.00	
2.50 X	106.00	
2.50 X	107.00	
2.50 X	108.00	
2.50 X	109.00	
2.50 X	110.00	
2.50 X	111.00	
2.50 X	112.00	
2.50 X	113.00	
2.50 X	114.00	
2.50 X	115.00	
2.50 X	116.00	
2.50 X	117.00	
2.50 X	118.00	
2.50 X	119.00	
2.50 X	120.00	
2.50 X	121.00	
2.50 X	122.00	
2.50 X	123.00	
2.50 X	124.00	
2.50 X	125.00	
2.50 X	126.00	
2.50 X	127.00	

CROSS SECTION (mm)	INSIDE DIAMETER (mm)	SIZE CROSS REF.
2.50 X	128.00	
2.50 X	129.00	
2.50 X	130.00	
2.50 X	131.00	
2.50 X	132.00	
2.50 X	133.00	
2.50 X	134.00	
2.50 X	135.00	
2.50 X	136.00	
2.50 X	137.00	
2.50 X	138.00	
2.50 X	139.00	
2.50 X	140.00	
2.50 X	141.00	
2.50 X	142.00	
2.50 X	143.00	
2.50 X	144.00	
2.50 X	145.00	
2.50 X	146.00	
2.50 X	147.00	
2.50 X	148.00	
2.50 X	149.00	
2.50 X	150.00	
2.55 X	29.10	
2.62 X	1.24	-102
2.62 X	2.06	-103
2.62 X	2.84	-104
2.62 X	3.63	-105
2.62 X	4.42	-106
2.62 X	5.23	-107
2.62 X	6.02	-108
2.62 X	7.59	-109
2.62 X	9.13	
2.62 X	9.19	-110
2.62 X	9.90	BS613
2.62 X	10.77	-111
2.62 X	11.91	BS614
2.62 X	12.37	-112
2.62 X	12.70	BS807
2.62 X	13.10	BS615
2.62 X	13.94	-113
2.62 X	15.08	BS616
2.62 X	15.54	-114
2.62 X	15.88	BS809
2.62 X	17.12	-115
2.62 X	17.46	BS810
2.62 X	17.86	BS617
2.62 X	18.72	-116
2.62 X	20.30	-117
2.62 X	20.64	BS812
2.62 X	21.89	-118

CROSS SECTION (mm)	INSIDE DIAMETER (mm)	SIZE CROSS REF.
2.62 X	22.23	BS813
2.62 X	23.47	-119
2.62 X	23.81	BS814
2.62 X	25.07	-120
2.62 X	26.64	-121
2.62 X	28.24	-122
2.62 X	29.82	-123
2.62 X	31.42	-124
2.62 X	32.99	-125
2.62 X	34.59	-126
2.62 X	36.17	-127
2.62 X	37.77	-128
2.62 X	39.34	-129
2.62 X	40.94	-130
2.62 X	42.52	-131
2.62 X	44.12	-132
2.62 X	45.69	-133
2.62 X	47.29	-134
2.62 X	48.90	-135
2.62 X	50.47	-136
2.62 X	52.07	-137
2.62 X	53.64	-138
2.62 X	55.25	-139
2.62 X	56.82	-140
2.62 X	58.42	-141
2.62 X	59.99	-142
2.62 X	61.60	-143
2.62 X	63.17	-144
2.62 X	64.77	-145
2.62 X	66.34	-146
2.62 X	67.95	-147
2.62 X	69.52	-148
2.62 X	71.12	-149
2.62 X	72.69	-150
2.62 X	74.30	BS640
2.62 X	75.87	-151
2.62 X	77.50	BS641
2.62 X	80.60	BS642
2.62 X	82.22	-152
2.62 X	83.80	BS643
2.62 X	88.57	-153
2.62 X	92.75	
2.62 X	94.92	-154
2.62 X	101.27	-155
2.62 X	107.62	-156
2.62 X	113.97	-157
2.62 X	120.32	-158
2.62 X	126.67	-159
2.62 X	133.02	-160
2.62 X	139.37	-161
2.62 X	145.72	-162
2.62 X	152.07	-163
2.62 X	158.42	-164

CROSS SECTION (mm)	INSIDE DIAMETER (mm)	SIZE CROSS REF.
2.62 X	164.77	-165
2.62 X	171.12	-166
2.62 X	177.47	-167
2.62 X	183.82	-168
2.62 X	190.17	-169
2.62 X	196.52	-170
2.62 X	202.87	-171
2.62 X	209.22	-172
2.62 X	215.57	-173
2.62 X	221.92	-174
2.62 X	228.27	-175
2.62 X	234.62	-176
2.62 X	240.97	-177
2.62 X	247.32	-178
2.65 X	14.00	
2.65 X	15.00	
2.65 X	16.00	
2.65 X	17.00	
2.65 X	18.00	
2.65 X	19.00	
2.65 X	20.00	
2.65 X	21.20	
2.65 X	22.40	
2.65 X	23.60	
2.65 X	25.00	
2.65 X	25.80	
2.65 X	26.50	
2.65 X	28.00	
2.65 X	30.00	
2.65 X	31.50	
2.65 X	32.50	
2.65 X	33.50	
2.65 X	34.50	
2.65 X	35.50	
2.65 X	36.50	
2.65 X	37.50	
2.65 X	38.70	
2.70 X	8.35	
2.70 X	8.90	
2.70 X	10.50	
2.70 X	12.10	
2.70 X	13.60	
2.70 X	15.10	
2.70 X	16.90	
2.70 X	18.40	
2.70 X	18.60	
2.70 X	27.30	
2.70 X	28.40	
2.70 X	117.00	
2.92 X	9.53	

Metric O-Rings (Continued)

(Metric O-Ring Tolerances – Page 40)

CROSS SECTION (mm)	INSIDE DIAMETER (mm)	SIZE CROSS REF.
2.95 X	21.92	-911
2.95 X	23.47	-912
2.95 X	25.04	-913
2.95 X	26.59	-914
2.95 X	29.74	-916
2.95 X	34.42	-918
3.00 X		
3.00 X	3.00	
3.00 X	3.50	
3.00 X	4.00	
3.00 X	4.50	
3.00 X	5.00	
3.00 X	5.50	
3.00 X	6.00	
3.00 X	6.50	
3.00 X	7.00	
3.00 X	7.50	
3.00 X	8.00	
3.00 X	8.50	
3.00 X	9.00	
3.00 X	9.50	
3.00 X	10.00	
3.00 X	10.50	
3.00 X	11.00	
3.00 X	11.50	
3.00 X	12.00	
3.00 X	12.50	
3.00 X	13.00	
3.00 X	13.50	
3.00 X	14.00	
3.00 X	14.50	
3.00 X	15.00	
3.00 X	15.50	
3.00 X	16.00	
3.00 X	16.50	
3.00 X	17.00	
3.00 X	17.50	
3.00 X	18.00	
3.00 X	18.20	
3.00 X	18.50	
3.00 X	19.00	
3.00 X	19.20	
3.00 X	19.50	
3.00 X	20.00	
3.00 X	20.50	
3.00 X	21.00	
3.00 X	21.50	
3.00 X	22.00	
3.00 X	22.20	
3.00 X	22.50	
3.00 X	23.00	
3.00 X	23.50	
3.00 X	24.00	

CROSS SECTION (mm)	INSIDE DIAMETER (mm)	SIZE CROSS REF.
3.00 X	24.20	
3.00 X	24.50	
3.00 X	24.60	
3.00 X	25.00	
3.00 X	25.20	
3.00 X	25.50	
3.00 X	26.00	
3.00 X	26.20	
3.00 X	26.50	
3.00 X	27.00	
3.00 X	27.50	
3.00 X	28.00	
3.00 X	28.50	
3.00 X	29.00	
3.00 X	29.20	
3.00 X	29.50	
3.00 X	30.00	
3.00 X	30.20	
3.00 X	30.50	
3.00 X	31.00	
3.00 X	31.50	
3.00 X	32.00	
3.00 X	32.20	
3.00 X	32.50	
3.00 X	33.00	
3.00 X	33.50	
3.00 X	34.00	
3.00 X	34.20	
3.00 X	34.50	
3.00 X	35.00	
3.00 X	35.50	
3.00 X	36.00	
3.00 X	36.20	
3.00 X	36.50	
3.00 X	37.00	
3.00 X	37.20	
3.00 X	37.47	-920
3.00 X	37.50	
3.00 X	38.00	
3.00 X	38.50	
3.00 X	39.00	
3.00 X	39.20	
3.00 X	39.50	
3.00 X	40.00	
3.00 X	40.20	
3.00 X	41.00	
3.00 X	41.50	
3.00 X	42.00	
3.00 X	42.20	
3.00 X	42.50	
3.00 X	43.00	
3.00 X	43.69	-924
3.00 X	44.00	

CROSS SECTION (mm)	INSIDE DIAMETER (mm)	SIZE CROSS REF.
3.00 X	44.20	
3.00 X	44.50	
3.00 X	45.00	
3.00 X	46.00	
3.00 X	47.00	
3.00 X	48.00	
3.00 X	49.00	
3.00 X	49.50	
3.00 X	50.00	
3.00 X	50.50	
3.00 X	51.00	
3.00 X	52.00	
3.00 X	53.00	
3.00 X	53.09	-928
3.00 X	54.00	
3.00 X	54.20	
3.00 X	54.50	
3.00 X	55.00	
3.00 X	56.00	
3.00 X	56.20	
3.00 X	57.00	
3.00 X	58.00	
3.00 X	59.00	
3.00 X	59.36	-932
3.00 X	59.50	
3.00 X	60.00	
3.00 X	61.00	
3.00 X	62.00	
3.00 X	62.20	
3.00 X	63.00	
3.00 X	64.00	
3.00 X	64.50	
3.00 X	65.00	
3.00 X	66.00	
3.00 X	67.00	
3.00 X	68.00	
3.00 X	69.00	
3.00 X	69.50	
3.00 X	70.00	
3.00 X	71.00	
3.00 X	72.00	
3.00 X	73.00	
3.00 X	74.00	
3.00 X	74.50	
3.00 X	75.00	
3.00 X	76.00	
3.00 X	77.00	
3.00 X	78.00	
3.00 X	79.00	
3.00 X	79.50	
3.00 X	80.00	
3.00 X	81.00	
3.00 X	82.00	

CROSS SECTION (mm)	INSIDE DIAMETER (mm)	SIZE CROSS REF.
3.00 X	83.00	
3.00 X	84.00	
3.00 X	84.50	
3.00 X	85.00	
3.00 X	86.00	
3.00 X	87.00	
3.00 X	88.00	
3.00 X	89.00	
3.00 X	89.50	
3.00 X	90.00	
3.00 X	91.00	
3.00 X	92.00	
3.00 X	93.00	
3.00 X	94.00	
3.00 X	94.50	
3.00 X	95.00	
3.00 X	96.00	
3.00 X	97.00	
3.00 X	98.00	
3.00 X	99.00	
3.00 X	99.50	
3.00 X	100.00	
3.00 X	101.00	
3.00 X	102.00	
3.00 X	103.00	
3.00 X	104.00	
3.00 X	104.50	
3.00 X	105.00	
3.00 X	106.00	
3.00 X	107.00	
3.00 X	108.00	
3.00 X	109.00	
3.00 X	109.50	
3.00 X	110.00	
3.00 X	111.00	
3.00 X	112.00	
3.00 X	113.00	
3.00 X	114.00	
3.00 X	114.50	
3.00 X	115.00	
3.00 X	116.00	
3.00 X	117.00	
3.00 X	118.00	
3.00 X	119.00	
3.00 X	119.50	
3.00 X	120.00	
3.00 X	121.00	
3.00 X	122.00	
3.00 X	123.00	
3.00 X	124.00	
3.00 X	124.50	
3.00 X	125.00	
3.00 X	126.00	

Metric O-Rings (Continued)

(Metric O-Ring Tolerances – Page 40)

CROSS SECTION (mm)	INSIDE DIAMETER (mm)	SIZE CROSS REF.
3.00 X	126.50	
3.00 X	127.00	
3.00 X	128.00	
3.00 X	129.00	
3.00 X	129.50	
3.00 X	130.00	
3.00 X	131.00	
3.00 X	132.00	
3.00 X	133.00	
3.00 X	134.00	
3.00 X	134.50	
3.00 X	135.00	
3.00 X	136.00	
3.00 X	137.00	
3.00 X	138.00	
3.00 X	139.00	
3.00 X	139.50	
3.00 X	140.00	
3.00 X	141.00	
3.00 X	142.00	
3.00 X	143.00	
3.00 X	144.00	
3.00 X	144.50	
3.00 X	145.00	
3.00 X	146.00	
3.00 X	147.00	
3.00 X	148.00	
3.00 X	149.00	
3.00 X	149.50	
3.00 X	150.00	
3.00 X	151.00	
3.00 X	152.00	
3.00 X	153.00	
3.00 X	154.00	
3.00 X	154.50	
3.00 X	155.00	
3.00 X	156.00	
3.00 X	157.00	
3.00 X	158.00	
3.00 X	159.00	
3.00 X	159.50	
3.00 X	160.00	
3.00 X	161.00	
3.00 X	162.00	
3.00 X	163.00	
3.00 X	164.00	
3.00 X	164.50	
3.00 X	165.00	
3.00 X	166.00	
3.00 X	167.00	
3.00 X	168.00	
3.00 X	169.00	
3.00 X	169.50	

CROSS SECTION (mm)	INSIDE DIAMETER (mm)	SIZE CROSS REF.
3.00 X	170.00	
3.00 X	171.00	
3.00 X	172.00	
3.00 X	173.00	
3.00 X	174.00	
3.00 X	174.50	
3.00 X	175.00	
3.00 X	176.00	
3.00 X	177.00	
3.00 X	178.00	
3.00 X	179.00	
3.00 X	179.50	
3.00 X	180.00	
3.00 X	181.00	
3.00 X	182.00	
3.00 X	183.00	
3.00 X	183.50	
3.00 X	184.00	
3.00 X	184.50	
3.00 X	185.00	
3.00 X	186.00	
3.00 X	187.00	
3.00 X	188.00	
3.00 X	189.00	
3.00 X	189.50	
3.00 X	190.00	
3.00 X	191.00	
3.00 X	192.00	
3.00 X	193.00	
3.00 X	194.00	
3.00 X	194.50	
3.00 X	195.00	
3.00 X	196.00	
3.00 X	197.00	
3.00 X	198.00	
3.00 X	199.00	
3.00 X	199.50	
3.00 X	200.00	
3.00 X	201.00	
3.00 X	202.00	
3.00 X	203.00	
3.00 X	204.00	
3.00 X	204.50	
3.00 X	205.00	
3.00 X	206.00	
3.00 X	207.00	
3.00 X	208.00	
3.00 X	209.00	
3.00 X	209.50	
3.00 X	210.00	
3.00 X	211.00	
3.00 X	212.00	
3.00 X	213.00	

CROSS SECTION (mm)	INSIDE DIAMETER (mm)	SIZE CROSS REF.
3.00 X	214.00	
3.00 X	215.00	
3.00 X	216.00	
3.00 X	217.00	
3.00 X	218.00	
3.00 X	219.00	
3.00 X	219.50	
3.00 X	220.00	
3.00 X	221.00	
3.00 X	222.00	
3.00 X	223.00	
3.00 X	224.00	
3.00 X	225.00	
3.00 X	226.00	
3.00 X	227.00	
3.00 X	228.00	
3.00 X	229.00	
3.00 X	229.50	
3.00 X	230.00	
3.00 X	231.00	
3.00 X	232.00	
3.00 X	233.00	
3.00 X	234.00	
3.00 X	235.00	
3.00 X	236.00	
3.00 X	237.00	
3.00 X	238.00	
3.00 X	239.00	
3.00 X	239.50	
3.00 X	240.00	
3.00 X	241.00	
3.00 X	242.00	
3.00 X	243.00	
3.00 X	244.00	
3.00 X	245.00	
3.00 X	246.00	
3.00 X	247.00	
3.00 X	248.00	
3.00 X	249.00	
3.00 X	249.50	
3.00 X	250.00	
3.00 X	255.00	
3.00 X	259.30	
3.00 X	260.00	
3.00 X	264.00	
3.00 X	270.00	
3.00 X	280.00	
3.00 X	300.00	
3.00 X	315.00	
3.00 X	320.00	
3.00 X	350.00	
3.00 X	440.00	
3.00 X	505.00	

CROSS SECTION (mm)	INSIDE DIAMETER (mm)	SIZE CROSS REF.
3.00 X	518.50	
3.10 X	24.40	G25
3.10 X	29.40	G30
3.10 X	34.40	G35
3.10 X	39.40	G40
3.10 X	44.40	G45
3.10 X	49.40	G50
3.10 X	54.40	G55
3.10 X	59.40	G60
3.10 X	64.40	G65
3.10 X	69.40	G70
3.10 X	74.40	G75
3.10 X	79.40	G80
3.10 X	84.40	G85
3.10 X	89.40	G90
3.10 X	94.40	G95
3.10 X	99.40	G100
3.10 X	104.40	G105
3.10 X	109.40	G110
3.10 X	114.40	G115
3.10 X	119.40	G120
3.10 X	124.40	G125
3.10 X	129.40	G130
3.10 X	134.40	G135
3.10 X	139.40	G140
3.10 X	144.40	G145
3.20 X	174.00	
3.20 X	219.50	
3.20 X	227.00	
3.50 X	5.00	
3.50 X	8.00	
3.50 X	9.00	
3.50 X	9.20	
3.50 X	10.00	
3.50 X	11.00	
3.50 X	12.00	
3.50 X	13.00	
3.50 X	14.00	
3.50 X	15.00	
3.50 X	16.00	
3.50 X	17.00	
3.50 X	17.50	
3.50 X	18.00	
3.50 X	19.00	
3.50 X	20.00	
3.50 X	21.00	
3.50 X	21.70	P22A
3.50 X	22.00	
3.50 X	22.10	P22.4
3.50 X	23.00	

Metric O-Rings (Continued)

(Metric O-Ring Tolerances – Page 40)

CROSS SECTION (mm)	INSIDE DIAMETER (mm)	SIZE CROSS REF.
3.50 X	23.70	P24
3.50 X	24.00	
3.50 X	24.70	P25
3.50 X	25.00	
3.50 X	25.20	P25.5
3.50 X	25.70	P26
3.50 X	26.00	
3.50 X	27.00	
3.50 X	27.70	P28
3.50 X	28.00	
3.50 X	28.70	P29
3.50 X	29.00	
3.50 X	29.20	P29.5
3.50 X	29.70	P30
3.50 X	30.00	
3.50 X	30.50	
3.50 X	30.70	P31
3.50 X	31.00	
3.50 X	31.20	P31.5
3.50 X	31.70	P32
3.50 X	32.00	
3.50 X	33.00	
3.50 X	33.70	P34
3.50 X	34.00	
3.50 X	34.70	P35
3.50 X	35.00	
3.50 X	35.20	P35.5
3.50 X	35.70	P36
3.50 X	36.00	
3.50 X	37.00	
3.50 X	37.70	P38
3.50 X	38.00	
3.50 X	38.70	P39
3.50 X	39.00	
3.50 X	39.70	P40
3.50 X	40.00	
3.50 X	40.70	P41
3.50 X	41.00	
3.50 X	41.70	P42
3.50 X	42.00	
3.50 X	43.00	
3.50 X	43.70	P44
3.50 X	44.00	
3.50 X	44.70	P45
3.50 X	45.00	
3.50 X	45.70	P46
3.50 X	46.00	
3.50 X	47.00	
3.50 X	47.70	P48
3.50 X	48.00	
3.50 X	48.70	P49
3.50 X	49.00	
3.50 X	49.70	P50

CROSS SECTION (mm)	INSIDE DIAMETER (mm)	SIZE CROSS REF.
3.50 X	50.00	
3.50 X	51.00	
3.50 X	52.00	
3.50 X	53.00	
3.50 X	54.00	
3.50 X	55.00	
3.50 X	56.00	
3.50 X	57.00	
3.50 X	58.00	
3.50 X	59.00	
3.50 X	60.00	
3.50 X	61.00	
3.50 X	62.00	
3.50 X	63.00	
3.50 X	64.00	
3.50 X	65.00	
3.50 X	66.00	
3.50 X	67.00	
3.50 X	68.00	
3.50 X	69.00	
3.50 X	70.00	
3.50 X	71.00	
3.50 X	72.00	
3.50 X	73.00	
3.50 X	74.00	
3.50 X	75.00	
3.50 X	76.00	
3.50 X	77.00	
3.50 X	78.00	
3.50 X	79.00	
3.50 X	80.00	
3.50 X	81.00	
3.50 X	82.00	
3.50 X	83.00	
3.50 X	84.00	
3.50 X	85.00	
3.50 X	86.00	
3.50 X	87.00	
3.50 X	88.00	
3.50 X	89.00	
3.50 X	90.00	
3.50 X	91.00	
3.50 X	92.00	
3.50 X	93.00	
3.50 X	94.00	
3.50 X	95.00	
3.50 X	96.00	
3.50 X	97.00	
3.50 X	98.00	
3.50 X	99.00	
3.50 X	100.00	
3.50 X	101.00	
3.50 X	102.00	

CROSS SECTION (mm)	INSIDE DIAMETER (mm)	SIZE CROSS REF.
3.50 X	103.00	
3.50 X	104.00	
3.50 X	105.00	
3.50 X	106.00	
3.50 X	107.00	
3.50 X	108.00	
3.50 X	109.00	
3.50 X	110.00	
3.50 X	111.00	
3.50 X	112.00	
3.50 X	113.00	
3.50 X	114.00	
3.50 X	115.00	
3.50 X	116.00	
3.50 X	117.00	
3.50 X	118.00	
3.50 X	119.00	
3.50 X	120.00	
3.50 X	121.00	
3.50 X	122.00	
3.50 X	123.00	
3.50 X	124.00	
3.50 X	125.00	
3.50 X	126.00	
3.50 X	127.00	
3.50 X	128.00	
3.50 X	129.00	
3.50 X	130.00	
3.50 X	131.00	
3.50 X	132.00	
3.50 X	133.00	
3.50 X	134.00	
3.50 X	135.00	
3.50 X	136.00	
3.50 X	137.00	
3.50 X	138.00	
3.50 X	139.00	
3.50 X	140.00	
3.50 X	141.00	
3.50 X	142.00	
3.50 X	143.00	
3.50 X	144.00	
3.50 X	145.00	
3.50 X	146.00	
3.50 X	147.00	
3.50 X	148.00	
3.50 X	149.00	
3.50 X	150.00	
3.50 X	151.00	
3.50 X	152.00	
3.50 X	153.00	
3.50 X	154.00	
3.50 X	155.00	

CROSS SECTION (mm)	INSIDE DIAMETER (mm)	SIZE CROSS REF.
3.50 X	156.00	
3.50 X	157.00	
3.50 X	158.00	
3.50 X	159.00	
3.50 X	160.00	
3.50 X	161.00	
3.50 X	162.00	
3.50 X	163.00	
3.50 X	164.00	
3.50 X	165.00	
3.50 X	166.00	
3.50 X	167.00	
3.50 X	168.00	
3.50 X	169.00	
3.50 X	170.00	
3.50 X	171.00	
3.50 X	172.00	
3.50 X	173.00	
3.50 X	174.00	
3.50 X	175.00	
3.50 X	176.00	
3.50 X	177.00	
3.50 X	178.00	
3.50 X	179.00	
3.50 X	180.00	
3.50 X	181.00	
3.50 X	182.00	
3.50 X	183.00	
3.50 X	184.00	
3.50 X	185.00	
3.50 X	186.00	
3.50 X	187.00	
3.50 X	188.00	
3.50 X	189.00	
3.50 X	190.00	
3.50 X	191.00	
3.50 X	192.00	
3.50 X	193.00	
3.50 X	194.00	
3.50 X	195.00	
3.50 X	196.00	
3.50 X	197.00	
3.50 X	198.00	
3.50 X	199.00	
3.50 X	200.00	
3.50 X	201.00	
3.50 X	202.00	
3.50 X	203.00	
3.50 X	204.00	
3.50 X	205.00	
3.50 X	206.00	
3.50 X	207.00	
3.50 X	208.00	

Metric O-Rings (Continued)

(Metric O-Ring Tolerances – Page 40)

CROSS SECTION (mm)	INSIDE DIAMETER (mm)	SIZE CROSS REF.
3.50	X	209.00
3.50	X	210.00
3.50	X	211.00
3.50	X	212.00
3.50	X	213.00
3.50	X	214.00
3.50	X	215.00
3.50	X	216.00
3.50	X	217.00
3.50	X	218.00
3.50	X	219.00
3.50	X	220.00
3.50	X	221.00
3.50	X	222.00
3.50	X	223.00
3.50	X	224.00
3.50	X	225.00
3.50	X	226.00
3.50	X	227.00
3.50	X	228.00
3.50	X	229.00
3.50	X	230.00
3.50	X	231.00
3.50	X	232.00
3.50	X	233.00
3.50	X	234.00
3.50	X	235.00
3.50	X	236.00
3.50	X	237.00
3.50	X	238.00
3.50	X	239.00
3.50	X	240.00
3.50	X	241.00
3.50	X	242.00
3.50	X	243.00
3.50	X	244.00
3.50	X	245.00
3.50	X	246.00
3.50	X	247.00
3.50	X	248.00
3.50	X	249.00
3.50	X	250.00
3.50	X	251.00
3.50	X	252.00
3.50	X	253.00
3.50	X	254.00
3.50	X	255.00
3.50	X	256.00
3.50	X	257.00
3.50	X	258.00
3.50	X	259.00
3.50	X	260.00
3.50	X	261.00

CROSS SECTION (mm)	INSIDE DIAMETER (mm)	SIZE CROSS REF.
3.50	X	262.00
3.50	X	263.00
3.50	X	264.00
3.50	X	265.00
3.50	X	266.00
3.50	X	267.00
3.50	X	268.00
3.50	X	269.00
3.50	X	270.00
3.50	X	271.00
3.50	X	272.00
3.50	X	273.00
3.50	X	274.00
3.50	X	275.00
3.50	X	276.00
3.50	X	277.00
3.50	X	278.00
3.50	X	279.00
3.50	X	280.00
3.50	X	281.00
3.50	X	282.00
3.50	X	283.00
3.50	X	284.00
3.50	X	285.00
3.50	X	286.00
3.50	X	287.00
3.50	X	288.00
3.50	X	289.00
3.50	X	290.00
3.50	X	291.00
3.50	X	292.00
3.50	X	293.00
3.50	X	294.00
3.50	X	295.00
3.50	X	296.00
3.50	X	297.00
3.50	X	298.00
3.50	X	299.00
3.50	X	300.00
3.50	X	301.00
3.50	X	302.00
3.50	X	303.00
3.50	X	304.00
3.50	X	305.00
3.50	X	306.00
3.50	X	307.00
3.50	X	308.00
3.50	X	309.00
3.50	X	310.00
3.50	X	311.00
3.50	X	312.00
3.50	X	313.00
3.50	X	314.00

CROSS SECTION (mm)	INSIDE DIAMETER (mm)	SIZE CROSS REF.
3.50	X	315.00
3.50	X	316.00
3.50	X	317.00
3.50	X	318.00
3.50	X	319.00
3.50	X	320.00
3.50	X	321.00
3.50	X	322.00
3.50	X	323.00
3.50	X	324.00
3.50	X	325.00
3.50	X	326.00
3.50	X	327.00
3.50	X	328.00
3.50	X	329.00
3.50	X	330.00
3.50	X	331.00
3.50	X	332.00
3.50	X	333.00
3.50	X	334.00
3.50	X	335.00
3.50	X	336.00
3.50	X	337.00
3.50	X	338.00
3.50	X	339.00
3.50	X	340.00
3.50	X	341.00
3.50	X	342.00
3.50	X	343.00
3.50	X	344.00
3.50	X	345.00
3.50	X	346.00
3.50	X	347.00
3.50	X	348.00
3.50	X	349.00
3.50	X	350.00
3.50	X	351.00
3.50	X	352.00
3.50	X	353.00
3.50	X	354.00
3.50	X	355.00
3.50	X	356.00
3.50	X	357.00
3.50	X	358.00
3.50	X	359.00
3.50	X	360.00
3.50	X	361.00
3.50	X	362.00
3.50	X	363.00
3.50	X	364.00
3.50	X	365.00
3.50	X	366.00
3.50	X	367.00

CROSS SECTION (mm)	INSIDE DIAMETER (mm)	SIZE CROSS REF.
3.50	X	368.00
3.50	X	369.00
3.50	X	370.00
3.50	X	371.00
3.50	X	372.00
3.50	X	373.00
3.50	X	374.00
3.50	X	375.00
3.50	X	376.00
3.50	X	377.00
3.50	X	378.00
3.50	X	379.00
3.50	X	380.00
3.50	X	381.00
3.50	X	382.00
3.50	X	383.00
3.50	X	384.00
3.50	X	385.00
3.50	X	386.00
3.50	X	387.00
3.50	X	388.00
3.50	X	389.00
3.50	X	390.00
3.50	X	391.00
3.50	X	392.00
3.50	X	393.00
3.50	X	394.00
3.50	X	395.00
3.50	X	396.00
3.50	X	397.00
3.50	X	398.00
3.50	X	399.00
3.50	X	400.00
3.50	X	401.00
3.50	X	402.00
3.50	X	403.00
3.50	X	404.00
3.50	X	405.00
3.50	X	406.00
3.50	X	407.00
3.50	X	408.00
3.50	X	409.00
3.50	X	410.00
3.50	X	411.00
3.50	X	412.00
3.50	X	413.00
3.50	X	414.00
3.50	X	415.00
3.50	X	416.00
3.50	X	417.00
3.50	X	418.00
3.50	X	419.00
3.50	X	420.00

Metric O-Rings (Continued)

(Metric O-Ring Tolerances – Page 40)

CROSS SECTION (mm)	INSIDE DIAMETER (mm)	SIZE CROSS REF.
3.50 X	421.00	
3.50 X	422.00	
3.50 X	423.00	
3.50 X	424.00	
3.50 X	425.00	
3.50 X	426.00	
3.50 X	427.00	
3.50 X	428.00	
3.50 X	429.00	
3.50 X	430.00	
3.50 X	431.00	
3.50 X	432.00	
3.50 X	433.00	
3.50 X	434.00	
3.50 X	435.00	
3.50 X	436.00	
3.50 X	437.00	
3.50 X	438.00	
3.50 X	439.00	
3.50 X	440.00	
3.53 X 4.34 -201		
3.53 X	5.94	-202
3.53 X	7.52	-203
3.53 X	9.12	-204
3.53 X	10.69	-205
3.53 X	12.29	-206
3.53 X	13.87	-207
3.53 X	15.47	-208
3.53 X	17.04	-209
3.53 X	18.64	-210
3.53 X	20.22	-211
3.53 X	21.82	-212
3.53 X	23.39	-213
3.53 X	24.99	-214
3.53 X	25.80	BS618
3.53 X	26.57	-215
3.53 X	28.17	-216
3.53 X	29.74	-217
3.53 X	31.34	-218
3.53 X	32.92	-219
3.53 X	34.52	-220
3.53 X	36.09	-221
3.53 X	37.69	-222
3.53 X	39.70	BS824
3.53 X	40.87	-223
3.53 X	41.28	BS825
3.53 X	42.86	BS826
3.53 X	44.04	-224
3.53 X	44.45	BS827
3.53 X	46.04	BS828
3.53 X	47.22	-225
3.53 X	47.62	BS829

CROSS SECTION (mm)	INSIDE DIAMETER (mm)	SIZE CROSS REF.
3.53 X	49.20	BS830
3.53 X	50.39	-226
3.53 X	50.80	BS831
3.53 X	52.40	BS832
3.53 X	53.57	-227
3.53 X	53.97	BS833
3.53 X	55.56	BS834
3.53 X	56.74	-228
3.53 X	57.15	BS835
3.53 X	58.74	BS836
3.53 X	59.92	-229
3.53 X	60.32	BS837
3.53 X	61.90	BS838
3.53 X	63.09	-230
3.53 X	63.50	BS839
3.53 X	65.10	BS840
3.53 X	66.27	-231
3.53 X	66.67	BS841
3.53 X	68.26	BS842
3.53 X	69.44	-232
3.53 X	69.85	BS843
3.53 X	71.44	BS844
3.53 X	72.62	-233
3.53 X	73.02	BS845
3.53 X	74.60	BS846
3.53 X	75.79	-234
3.53 X	78.97	-235
3.53 X	82.14	-236
3.53 X	85.32	-237
3.53 X	88.49	-238
3.53 X	91.67	-239
3.53 X	94.84	-240
3.53 X	98.02	-241
3.53 X	101.19	-242
3.53 X	104.37	-243
3.53 X	107.54	-244
3.53 X	110.72	-245
3.53 X	113.89	-246
3.53 X	117.07	-247
3.53 X	120.24	-248
3.53 X	123.42	-249
3.53 X	126.59	-250
3.53 X	129.77	-251
3.53 X	132.94	-252
3.53 X	136.12	-253
3.53 X	139.29	-254
3.53 X	142.47	-255
3.53 X	145.64	-256
3.53 X	148.82	-257
3.53 X	151.99	-258
3.53 X	158.34	-259
3.53 X	158.82	
3.53 X	164.69	-260

CROSS SECTION (mm)	INSIDE DIAMETER (mm)	SIZE CROSS REF.
3.53 X	171.04	-261
3.53 X	177.39	-262
3.53 X	183.74	-263
3.53 X	190.09	-264
3.53 X	196.44	-265
3.53 X	202.79	-266
3.53 X	209.14	-267
3.53 X	215.49	-268
3.53 X	221.84	-269
3.53 X	228.19	-270
3.53 X	234.54	-271
3.53 X	240.89	-272
3.53 X	247.24	-273
3.53 X	253.59	-274
3.53 X	266.29	-275
3.53 X	278.99	-276
3.53 X	291.69	-277
3.53 X	304.39	-278
3.53 X	319.20	
3.53 X	329.79	-279
3.53 X	355.19	-280
3.53 X	380.59	-281
3.53 X	405.26	-282
3.53 X	430.66	-283
3.53 X	456.06	-284
3.55 X 18.00		
3.55 X	19.00	
3.55 X	20.00	
3.55 X	21.20	
3.55 X	22.40	
3.55 X	23.60	
3.55 X	25.00	
3.55 X	25.80	
3.55 X	26.50	
3.55 X	28.00	
3.55 X	30.00	
3.55 X	31.50	
3.55 X	32.50	
3.55 X	33.50	
3.55 X	34.50	
3.55 X	35.50	
3.55 X	36.50	
3.55 X	37.50	
3.55 X	38.70	
3.55 X	40.00	
3.55 X	41.20	
3.55 X	42.50	
3.55 X	43.70	
3.55 X	45.00	
3.55 X	46.20	
3.55 X	47.50	
3.55 X	48.70	

CROSS SECTION (mm)	INSIDE DIAMETER (mm)	SIZE CROSS REF.
3.55 X	50.00	
3.55 X	51.50	
3.55 X	53.00	
3.55 X	54.50	
3.55 X	56.00	
3.55 X	58.00	
3.55 X	60.00	
3.55 X	61.50	
3.55 X	63.00	
3.55 X	65.00	
3.55 X	67.00	
3.55 X	69.00	
3.55 X	71.00	
3.55 X	73.00	
3.55 X	75.00	
3.55 X	77.50	
3.55 X	80.00	
3.55 X	82.50	
3.55 X	85.00	
3.55 X	87.50	
3.55 X	90.00	
3.55 X	92.50	
3.55 X	95.00	
3.55 X	97.50	
3.55 X	100.00	
3.55 X	103.00	
3.55 X	106.00	
3.55 X	109.00	
3.55 X	112.00	
3.55 X	115.00	
3.55 X	118.00	
3.55 X	122.00	
3.55 X	125.00	
3.55 X	128.00	
3.55 X	132.00	
3.55 X	136.00	
3.55 X	140.00	
3.55 X	145.00	
3.55 X	150.00	
3.55 X	155.00	
3.55 X	160.00	
3.55 X	165.00	
3.55 X	170.00	
3.55 X	175.00	
3.55 X	180.00	
3.55 X	185.00	
3.55 X	190.00	
3.55 X	195.00	
3.55 X	200.00	
3.60 X 18.30		
3.60 X	19.80	
3.60 X	21.30	

Metric O-Rings (Continued)

(Metric O-Ring Tolerances – Page 40)

CROSS SECTION (mm)	INSIDE DIAMETER (mm)	SIZE CROSS REF.
3.60 X	23.00	
3.60 X	24.60	
3.60 X	26.20	
3.60 X	27.80	
3.60 X	29.30	
3.60 X	30.80	
3.60 X	32.50	
3.60 X	34.10	
3.60 X	35.60	
3.60 X	37.30	
3.60 X	43.40	
4.00 X	4.00	
4.00 X	5.00	
4.00 X	6.00	
4.00 X	7.00	
4.00 X	7.60	
4.00 X	8.00	
4.00 X	9.00	
4.00 X	10.00	
4.00 X	11.00	
4.00 X	12.00	
4.00 X	13.00	
4.00 X	14.00	
4.00 X	14.50	V15
4.00 X	15.00	
4.00 X	16.00	
4.00 X	17.00	
4.00 X	18.00	
4.00 X	19.00	
4.00 X	20.00	
4.00 X	21.00	
4.00 X	22.00	
4.00 X	23.00	
4.00 X	23.50	V24
4.00 X	24.00	
4.00 X	25.00	
4.00 X	26.00	
4.00 X	27.00	
4.00 X	28.00	
4.00 X	29.00	
4.00 X	30.00	
4.00 X	31.00	
4.00 X	32.00	
4.00 X	33.00	
4.00 X	33.50	V34
4.00 X	34.00	
4.00 X	35.00	
4.00 X	36.00	
4.00 X	37.00	
4.00 X	38.00	
4.00 X	39.00	
4.00 X	39.50	V40

CROSS SECTION (mm)	INSIDE DIAMETER (mm)	SIZE CROSS REF.
4.00 X	40.00	
4.00 X	41.00	
4.00 X	42.00	
4.00 X	43.00	
4.00 X	44.00	
4.00 X	45.00	
4.00 X	46.00	
4.00 X	47.00	
4.00 X	48.00	
4.00 X	49.00	
4.00 X	50.00	
4.00 X	51.00	
4.00 X	52.00	
4.00 X	53.00	
4.00 X	54.00	
4.00 X	54.50	V55
4.00 X	55.00	
4.00 X	56.00	
4.00 X	57.00	
4.00 X	58.00	
4.00 X	59.00	
4.00 X	60.00	
4.00 X	61.00	
4.00 X	62.00	
4.00 X	63.00	
4.00 X	64.00	
4.00 X	65.00	
4.00 X	66.00	
4.00 X	67.00	
4.00 X	68.00	
4.00 X	69.00	V70
4.00 X	70.00	
4.00 X	71.00	
4.00 X	72.00	
4.00 X	73.00	
4.00 X	74.00	
4.00 X	75.00	
4.00 X	76.00	
4.00 X	77.00	
4.00 X	78.00	
4.00 X	79.00	
4.00 X	80.00	
4.00 X	81.00	
4.00 X	82.00	
4.00 X	83.00	
4.00 X	84.00	V85
4.00 X	85.00	
4.00 X	86.00	
4.00 X	86.50	
4.00 X	87.00	
4.00 X	88.00	
4.00 X	89.00	
4.00 X	90.00	

CROSS SECTION (mm)	INSIDE DIAMETER (mm)	SIZE CROSS REF.
4.00 X	91.00	
4.00 X	92.00	
4.00 X	93.00	
4.00 X	94.00	
4.00 X	95.00	
4.00 X	96.00	
4.00 X	97.00	
4.00 X	98.00	
4.00 X	99.00	V100
4.00 X	100.00	
4.00 X	101.00	
4.00 X	102.00	
4.00 X	103.00	
4.00 X	104.00	
4.00 X	105.00	
4.00 X	106.00	
4.00 X	107.00	
4.00 X	108.00	
4.00 X	109.00	
4.00 X	110.00	
4.00 X	111.00	
4.00 X	112.00	
4.00 X	113.00	
4.00 X	114.00	
4.00 X	115.00	
4.00 X	116.00	
4.00 X	117.00	
4.00 X	118.00	
4.00 X	119.00	V120
4.00 X	120.00	
4.00 X	121.00	
4.00 X	122.00	
4.00 X	123.00	
4.00 X	124.00	
4.00 X	125.00	
4.00 X	126.00	
4.00 X	127.00	
4.00 X	128.00	
4.00 X	129.00	
4.00 X	130.00	
4.00 X	131.00	
4.00 X	132.00	
4.00 X	133.00	
4.00 X	134.00	
4.00 X	135.00	
4.00 X	136.00	
4.00 X	137.00	
4.00 X	138.00	
4.00 X	139.00	
4.00 X	140.00	
4.00 X	141.00	
4.00 X	142.00	
4.00 X	143.00	

CROSS SECTION (mm)	INSIDE DIAMETER (mm)	SIZE CROSS REF.
4.00 X	144.00	
4.00 X	145.00	
4.00 X	146.00	
4.00 X	147.00	
4.00 X	148.00	
4.00 X	148.50	V150
4.00 X	149.00	
4.00 X	150.00	
4.00 X	151.00	
4.00 X	152.00	
4.00 X	153.00	
4.00 X	154.00	
4.00 X	155.00	
4.00 X	156.00	
4.00 X	157.00	
4.00 X	158.00	
4.00 X	159.00	
4.00 X	160.00	
4.00 X	161.00	
4.00 X	162.00	
4.00 X	163.00	
4.00 X	164.00	
4.00 X	165.00	
4.00 X	166.00	
4.00 X	167.00	
4.00 X	168.00	
4.00 X	169.00	
4.00 X	170.00	
4.00 X	171.00	
4.00 X	172.00	
4.00 X	173.00	V175
4.00 X	174.00	
4.00 X	175.00	
4.00 X	176.00	
4.00 X	177.00	
4.00 X	178.00	
4.00 X	179.00	
4.00 X	180.00	
4.00 X	181.00	
4.00 X	182.00	
4.00 X	183.00	
4.00 X	184.00	
4.00 X	185.00	
4.00 X	186.00	
4.00 X	187.00	
4.00 X	188.00	
4.00 X	189.00	
4.00 X	190.00	
4.00 X	191.00	
4.00 X	192.00	
4.00 X	193.00	
4.00 X	194.00	
4.00 X	195.00	

Metric O-Rings (Continued)

(Metric O-Ring Tolerances – Page 40)

CROSS SECTION (mm)	INSIDE DIAMETER (mm)	SIZE CROSS REF.
4.00 X	196.00	
4.00 X	197.00	
4.00 X	198.00	
4.00 X	199.00	
4.00 X	200.00	
4.00 X	201.00	
4.00 X	202.00	
4.00 X	203.00	
4.00 X	204.00	
4.00 X	205.00	
4.00 X	206.00	
4.00 X	207.00	
4.00 X	208.00	
4.00 X	209.00	
4.00 X	210.00	
4.00 X	211.00	
4.00 X	212.00	
4.00 X	213.00	
4.00 X	214.00	
4.00 X	215.00	
4.00 X	216.00	
4.00 X	217.00	
4.00 X	218.00	
4.00 X	219.00	
4.00 X	220.00	
4.00 X	221.00	
4.00 X	222.00	
4.00 X	223.00	
4.00 X	224.00	
4.00 X	225.00	
4.00 X	226.00	
4.00 X	227.00	
4.00 X	228.00	
4.00 X	229.00	
4.00 X	230.00	
4.00 X	231.00	
4.00 X	232.00	
4.00 X	233.00	
4.00 X	234.00	
4.00 X	235.00	
4.00 X	236.00	
4.00 X	237.00	
4.00 X	238.00	
4.00 X	239.00	
4.00 X	240.00	
4.00 X	241.00	
4.00 X	242.00	
4.00 X	243.00	
4.00 X	244.00	
4.00 X	245.00	
4.00 X	246.00	
4.00 X	247.00	
4.00 X	248.00	

CROSS SECTION (mm)	INSIDE DIAMETER (mm)	SIZE CROSS REF.
4.00 X	249.00	
4.00 X	250.00	
4.00 X	251.00	
4.00 X	252.00	
4.00 X	253.00	
4.00 X	254.00	
4.00 X	255.00	
4.00 X	256.00	
4.00 X	257.00	
4.00 X	258.00	
4.00 X	259.00	
4.00 X	260.00	
4.00 X	261.00	
4.00 X	262.00	
4.00 X	263.00	
4.00 X	264.00	
4.00 X	265.00	
4.00 X	266.00	
4.00 X	267.00	
4.00 X	268.00	
4.00 X	269.00	
4.00 X	270.00	
4.00 X	271.00	
4.00 X	272.00	
4.00 X	273.00	
4.00 X	274.00	
4.00 X	275.00	
4.00 X	276.00	
4.00 X	277.00	
4.00 X	278.00	
4.00 X	279.00	
4.00 X	280.00	
4.00 X	281.00	
4.00 X	282.00	
4.00 X	283.00	
4.00 X	284.00	
4.00 X	285.00	
4.00 X	286.00	
4.00 X	287.00	
4.00 X	288.00	
4.00 X	289.00	
4.00 X	290.00	
4.00 X	291.00	
4.00 X	292.00	
4.00 X	293.00	
4.00 X	294.00	
4.00 X	295.00	
4.00 X	296.00	
4.00 X	297.00	
4.00 X	298.00	
4.00 X	299.00	
4.00 X	300.00	
4.00 X	301.00	

CROSS SECTION (mm)	INSIDE DIAMETER (mm)	SIZE CROSS REF.
4.00 X	302.00	
4.00 X	303.00	
4.00 X	304.00	
4.00 X	305.00	
4.00 X	306.00	
4.00 X	307.00	
4.00 X	308.00	
4.00 X	309.00	
4.00 X	310.00	
4.00 X	311.00	
4.00 X	312.00	
4.00 X	313.00	
4.00 X	314.00	
4.00 X	315.00	
4.00 X	316.00	
4.00 X	317.00	
4.00 X	318.00	
4.00 X	319.00	
4.00 X	320.00	
4.00 X	321.00	
4.00 X	322.00	
4.00 X	323.00	
4.00 X	324.00	
4.00 X	325.00	
4.00 X	326.00	
4.00 X	327.00	
4.00 X	328.00	
4.00 X	329.00	
4.00 X	330.00	
4.00 X	331.00	
4.00 X	332.00	
4.00 X	333.00	
4.00 X	334.00	
4.00 X	335.00	
4.00 X	336.00	
4.00 X	337.00	
4.00 X	338.00	
4.00 X	339.00	
4.00 X	340.00	
4.00 X	341.00	
4.00 X	342.00	
4.00 X	343.00	
4.00 X	344.00	
4.00 X	345.00	
4.00 X	346.00	
4.00 X	347.00	
4.00 X	348.00	
4.00 X	349.00	
4.00 X	350.00	
4.00 X	351.00	
4.00 X	352.00	
4.00 X	353.00	
4.00 X	354.00	

CROSS SECTION (mm)	INSIDE DIAMETER (mm)	SIZE CROSS REF.
4.00 X	355.00	
4.00 X	356.00	
4.00 X	357.00	
4.00 X	358.00	
4.00 X	359.00	
4.00 X	360.00	
4.00 X	361.00	
4.00 X	362.00	
4.00 X	363.00	
4.00 X	364.00	
4.00 X	365.00	
4.00 X	366.00	
4.00 X	367.00	
4.00 X	368.00	
4.00 X	369.00	
4.00 X	370.00	
4.00 X	371.00	
4.00 X	372.00	
4.00 X	373.00	
4.00 X	374.00	
4.00 X	375.00	
4.00 X	376.00	
4.00 X	377.00	
4.00 X	378.00	
4.00 X	379.00	
4.00 X	380.00	
4.00 X	381.00	
4.00 X	382.00	
4.00 X	383.00	
4.00 X	384.00	
4.00 X	385.00	
4.00 X	386.00	
4.00 X	387.00	
4.00 X	388.00	
4.00 X	389.00	
4.00 X	390.00	
4.00 X	391.00	
4.00 X	392.00	
4.00 X	393.00	
4.00 X	394.00	
4.00 X	395.00	
4.00 X	396.00	
4.00 X	397.00	
4.00 X	398.00	
4.00 X	399.00	
4.00 X	400.00	
4.00 X	401.00	
4.00 X	402.00	
4.00 X	403.00	
4.00 X	404.00	
4.00 X	405.00	
4.00 X	406.00	
4.00 X	407.00	

Metric O-Rings (Continued)

(Metric O-Ring Tolerances – Page 40)

CROSS SECTION (mm)	INSIDE DIAMETER (mm)	SIZE CROSS REF.
4.00 X	408.00	
4.00 X	409.00	
4.00 X	410.00	
4.00 X	411.00	
4.00 X	412.00	
4.00 X	413.00	
4.00 X	414.00	
4.00 X	415.00	
4.00 X	416.00	
4.00 X	417.00	
4.00 X	418.00	
4.00 X	419.00	
4.00 X	420.00	
4.00 X	421.00	
4.00 X	422.00	
4.00 X	423.00	
4.00 X	424.00	
4.00 X	425.00	
4.00 X	426.00	
4.00 X	427.00	
4.00 X	428.00	
4.00 X	429.00	
4.00 X	430.00	
4.00 X	431.00	
4.00 X	432.00	
4.00 X	433.00	
4.00 X	434.00	
4.00 X	435.00	
4.00 X	436.00	
4.00 X	437.00	
4.00 X	438.00	
4.00 X	439.00	
4.00 X	440.00	
4.00 X	441.00	
4.00 X	442.00	
4.00 X	443.00	
4.00 X	444.00	
4.00 X	445.00	
4.00 X	446.00	
4.00 X	447.00	
4.00 X	448.00	
4.00 X	449.00	
4.00 X	450.00	
4.00 X	451.00	
4.00 X	452.00	
4.00 X	453.00	
4.00 X	454.00	
4.00 X	455.00	
4.00 X	456.00	
4.00 X	457.00	
4.00 X	458.00	
4.00 X	459.00	
4.00 X	460.00	

CROSS SECTION (mm)	INSIDE DIAMETER (mm)	SIZE CROSS REF.
4.00 X	461.00	
4.00 X	462.00	
4.00 X	463.00	
4.00 X	464.00	
4.00 X	465.00	
4.00 X	466.00	
4.00 X	467.00	
4.00 X	468.00	
4.00 X	469.00	
4.00 X	470.00	
4.00 X	471.00	
4.00 X	472.00	
4.00 X	473.00	
4.00 X	474.00	
4.00 X	475.00	
4.00 X	476.00	
4.00 X	477.00	
4.00 X	478.00	
4.00 X	479.00	
4.00 X	480.00	
4.00 X	481.00	
4.00 X	482.00	
4.00 X	483.00	
4.00 X	484.00	
4.00 X	485.00	
4.00 X	486.00	
4.00 X	487.00	
4.00 X	488.00	
4.00 X	489.00	
4.00 X	490.00	
4.00 X	491.00	
4.00 X	492.00	
4.00 X	493.00	
4.00 X	494.00	
4.00 X	495.00	
4.00 X	496.00	
4.00 X	497.00	
4.00 X	498.00	
4.00 X	499.00	
4.00 X	500.00	
4.20 X	139.00	
4.50 X	6.00	
4.50 X	8.00	
4.50 X	9.00	
4.50 X	9.50	
4.50 X	10.00	
4.50 X	10.50	
4.50 X	11.00	
4.50 X	12.00	
4.50 X	13.00	
4.50 X	15.00	

CROSS SECTION (mm)	INSIDE DIAMETER (mm)	SIZE CROSS REF.
4.50 X	15.50	
4.50 X	16.00	
4.50 X	17.00	
4.50 X	18.00	
4.50 X	19.00	
4.50 X	20.00	
4.50 X	21.00	
4.50 X	21.50	
4.50 X	22.00	
4.50 X	22.50	
4.50 X	23.00	
4.50 X	24.00	
4.50 X	24.50	
4.50 X	25.00	
4.50 X	26.00	
4.50 X	27.00	
4.50 X	27.50	
4.50 X	28.00	
4.50 X	28.50	
4.50 X	29.00	
4.50 X	29.50	
4.50 X	30.00	
4.50 X	31.00	
4.50 X	31.50	
4.50 X	32.00	
4.50 X	33.00	
4.50 X	34.00	
4.50 X	34.50	
4.50 X	35.00	
4.50 X	35.50	
4.50 X	36.00	
4.50 X	37.00	
4.50 X	37.50	
4.50 X	38.00	
4.50 X	39.00	
4.50 X	40.00	
4.50 X	40.50	
4.50 X	41.00	
4.50 X	42.00	
4.50 X	43.00	
4.50 X	44.00	
4.50 X	45.00	
4.50 X	46.00	
4.50 X	47.00	
4.50 X	48.00	
4.50 X	49.00	
4.50 X	50.00	
4.50 X	51.00	
4.50 X	53.00	
4.50 X	56.00	
4.50 X	57.00	
4.50 X	60.00	
4.50 X	61.00	

CROSS SECTION (mm)	INSIDE DIAMETER (mm)	SIZE CROSS REF.
4.50 X	62.00	
4.50 X	63.00	
4.50 X	64.00	
4.50 X	65.00	
4.50 X	66.00	
4.50 X	68.00	
4.50 X	69.00	
4.50 X	70.00	
4.50 X	71.00	
4.50 X	73.00	
4.50 X	74.00	
4.50 X	75.00	
4.50 X	76.00	
4.50 X	80.00	
4.50 X	81.00	
4.50 X	83.00	
4.50 X	85.00	
4.50 X	86.00	
4.50 X	89.00	
4.50 X	90.00	
4.50 X	92.00	
4.50 X	93.50	
4.50 X	95.00	
4.50 X	97.50	
4.50 X	98.00	
4.50 X	99.50	
4.50 X	100.00	
4.50 X	100.50	
4.50 X	101.00	
4.50 X	103.50	
4.50 X	105.00	
4.50 X	106.00	
4.50 X	110.00	
4.50 X	115.00	
4.50 X	118.00	
4.50 X	120.00	
4.50 X	122.00	
4.50 X	124.00	
4.50 X	126.00	
4.50 X	128.00	
4.50 X	130.00	
4.50 X	131.50	
4.50 X	134.50	
4.50 X	137.00	
4.50 X	140.00	
4.50 X	140.50	
4.50 X	150.00	
4.50 X	153.00	
4.50 X	155.00	
4.50 X	157.00	
4.50 X	160.00	
4.50 X	165.00	
4.50 X	172.00	

Metric O-Rings (Continued)

(Metric O-Ring Tolerances – Page 40)

CROSS SECTION (mm)	INSIDE DIAMETER (mm)	SIZE CROSS REF.
4.50 X	178.00	
4.50 X	180.00	
4.50 X	185.00	
4.50 X	186.00	
4.50 X	189.50	
4.50 X	192.00	
4.50 X	208.00	
4.50 X	215.00	
4.50 X	218.50	
4.50 X	225.00	
4.50 X	227.00	
4.50 X	250.00	
4.50 X	267.00	
4.50 X	280.00	
4.50 X	315.00	
4.76 X	7.93	
5.00 X	4.00	
5.00 X	5.00	
5.00 X	6.00	
5.00 X	7.00	
5.00 X	8.00	
5.00 X	9.00	
5.00 X	10.00	
5.00 X	11.00	
5.00 X	12.00	
5.00 X	13.00	
5.00 X	14.00	
5.00 X	15.00	
5.00 X	16.00	
5.00 X	17.00	
5.00 X	18.00	
5.00 X	19.00	
5.00 X	20.00	
5.00 X	21.00	
5.00 X	22.00	
5.00 X	23.00	
5.00 X	24.00	
5.00 X	25.00	
5.00 X	26.00	
5.00 X	27.00	
5.00 X	28.00	
5.00 X	29.00	
5.00 X	30.00	
5.00 X	31.00	
5.00 X	32.00	
5.00 X	33.00	
5.00 X	34.00	
5.00 X	35.00	
5.00 X	36.00	
5.00 X	37.00	
5.00 X	38.00	

CROSS SECTION (mm)	INSIDE DIAMETER (mm)	SIZE CROSS REF.
5.00 X	39.00	
5.00 X	40.00	
5.00 X	41.00	
5.00 X	42.00	
5.00 X	43.00	
5.00 X	44.00	
5.00 X	45.00	
5.00 X	46.00	
5.00 X	47.00	
5.00 X	48.00	
5.00 X	49.00	
5.00 X	50.00	
5.00 X	51.00	
5.00 X	52.00	
5.00 X	53.00	
5.00 X	54.00	
5.00 X	55.00	
5.00 X	56.00	
5.00 X	57.00	
5.00 X	58.00	
5.00 X	59.00	
5.00 X	60.00	
5.00 X	61.00	
5.00 X	62.00	
5.00 X	63.00	
5.00 X	64.00	
5.00 X	65.00	
5.00 X	66.00	
5.00 X	67.00	
5.00 X	68.00	
5.00 X	69.00	
5.00 X	70.00	
5.00 X	71.00	
5.00 X	72.00	
5.00 X	73.00	
5.00 X	74.00	
5.00 X	75.00	
5.00 X	76.00	
5.00 X	77.00	
5.00 X	78.00	
5.00 X	79.00	
5.00 X	80.00	
5.00 X	81.00	
5.00 X	82.00	
5.00 X	83.00	
5.00 X	84.00	
5.00 X	85.00	
5.00 X	86.00	
5.00 X	87.00	
5.00 X	88.00	
5.00 X	89.00	
5.00 X	90.00	
5.00 X	91.00	

CROSS SECTION (mm)	INSIDE DIAMETER (mm)	SIZE CROSS REF.
5.00 X	92.00	
5.00 X	93.00	
5.00 X	94.00	
5.00 X	95.00	
5.00 X	96.00	
5.00 X	97.00	
5.00 X	98.00	
5.00 X	99.00	
5.00 X	100.00	
5.00 X	101.00	
5.00 X	102.00	
5.00 X	103.00	
5.00 X	104.00	
5.00 X	105.00	
5.00 X	106.00	
5.00 X	107.00	
5.00 X	108.00	
5.00 X	109.00	
5.00 X	110.00	
5.00 X	111.00	
5.00 X	112.00	
5.00 X	113.00	
5.00 X	114.00	
5.00 X	115.00	
5.00 X	116.00	
5.00 X	117.00	
5.00 X	118.00	
5.00 X	119.00	
5.00 X	120.00	
5.00 X	121.00	
5.00 X	122.00	
5.00 X	123.00	
5.00 X	124.00	
5.00 X	125.00	
5.00 X	126.00	
5.00 X	127.00	
5.00 X	128.00	
5.00 X	129.00	
5.00 X	130.00	
5.00 X	131.00	
5.00 X	132.00	
5.00 X	133.00	
5.00 X	134.00	
5.00 X	135.00	
5.00 X	136.00	
5.00 X	137.00	
5.00 X	138.00	
5.00 X	139.00	
5.00 X	140.00	
5.00 X	141.00	
5.00 X	142.00	
5.00 X	143.00	
5.00 X	144.00	

CROSS SECTION (mm)	INSIDE DIAMETER (mm)	SIZE CROSS REF.
5.00 X	145.00	
5.00 X	146.00	
5.00 X	147.00	
5.00 X	148.00	
5.00 X	149.00	
5.00 X	150.00	
5.00 X	151.00	
5.00 X	152.00	
5.00 X	153.00	
5.00 X	154.00	
5.00 X	155.00	
5.00 X	156.00	
5.00 X	157.00	
5.00 X	158.00	
5.00 X	159.00	
5.00 X	160.00	
5.00 X	161.00	
5.00 X	162.00	
5.00 X	163.00	
5.00 X	164.00	
5.00 X	165.00	
5.00 X	166.00	
5.00 X	167.00	
5.00 X	168.00	
5.00 X	169.00	
5.00 X	170.00	
5.00 X	171.00	
5.00 X	172.00	
5.00 X	173.00	
5.00 X	174.00	
5.00 X	175.00	
5.00 X	176.00	
5.00 X	177.00	
5.00 X	178.00	
5.00 X	179.00	
5.00 X	180.00	
5.00 X	181.00	
5.00 X	182.00	
5.00 X	183.00	
5.00 X	184.00	
5.00 X	185.00	
5.00 X	186.00	
5.00 X	187.00	
5.00 X	188.00	
5.00 X	189.00	
5.00 X	190.00	
5.00 X	191.00	
5.00 X	192.00	
5.00 X	193.00	
5.00 X	194.00	
5.00 X	195.00	
5.00 X	196.00	
5.00 X	197.00	

Metric O-Rings (Continued)

(Metric O-Ring Tolerances – Page 40)

CROSS SECTION (mm)	INSIDE DIAMETER (mm)	SIZE CROSS REF.
5.00	X 198.00	
5.00	X 199.00	
5.00	X 200.00	
5.00	X 201.00	
5.00	X 202.00	
5.00	X 203.00	
5.00	X 204.00	
5.00	X 205.00	
5.00	X 206.00	
5.00	X 207.00	
5.00	X 208.00	
5.00	X 209.00	
5.00	X 210.00	
5.00	X 211.00	
5.00	X 212.00	
5.00	X 213.00	
5.00	X 214.00	
5.00	X 215.00	
5.00	X 216.00	
5.00	X 217.00	
5.00	X 218.00	
5.00	X 219.00	
5.00	X 220.00	
5.00	X 221.00	
5.00	X 222.00	
5.00	X 223.00	
5.00	X 224.00	
5.00	X 225.00	
5.00	X 226.00	
5.00	X 227.00	
5.00	X 228.00	
5.00	X 229.00	
5.00	X 230.00	
5.00	X 231.00	
5.00	X 232.00	
5.00	X 233.00	
5.00	X 234.00	
5.00	X 235.00	
5.00	X 236.00	
5.00	X 237.00	
5.00	X 238.00	
5.00	X 239.00	
5.00	X 240.00	
5.00	X 241.00	
5.00	X 242.00	
5.00	X 243.00	
5.00	X 244.00	
5.00	X 245.00	
5.00	X 246.00	
5.00	X 247.00	
5.00	X 248.00	
5.00	X 249.00	
5.00	X 250.00	

CROSS SECTION (mm)	INSIDE DIAMETER (mm)	SIZE CROSS REF.
5.00	X 251.00	
5.00	X 252.00	
5.00	X 253.00	
5.00	X 254.00	
5.00	X 255.00	
5.00	X 256.00	
5.00	X 257.00	
5.00	X 258.00	
5.00	X 259.00	
5.00	X 260.00	
5.00	X 261.00	
5.00	X 262.00	
5.00	X 263.00	
5.00	X 264.00	
5.00	X 265.00	
5.00	X 266.00	
5.00	X 267.00	
5.00	X 268.00	
5.00	X 269.00	
5.00	X 270.00	
5.00	X 271.00	
5.00	X 272.00	
5.00	X 273.00	
5.00	X 274.00	
5.00	X 275.00	
5.00	X 276.00	
5.00	X 277.00	
5.00	X 278.00	
5.00	X 279.00	
5.00	X 280.00	
5.00	X 281.00	
5.00	X 282.00	
5.00	X 283.00	
5.00	X 284.00	
5.00	X 285.00	
5.00	X 286.00	
5.00	X 287.00	
5.00	X 288.00	
5.00	X 289.00	
5.00	X 290.00	
5.00	X 291.00	
5.00	X 292.00	
5.00	X 293.00	
5.00	X 294.00	
5.00	X 295.00	
5.00	X 296.00	
5.00	X 297.00	
5.00	X 298.00	
5.00	X 299.00	
5.00	X 300.00	
5.00	X 301.00	
5.00	X 302.00	
5.00	X 303.00	

CROSS SECTION (mm)	INSIDE DIAMETER (mm)	SIZE CROSS REF.
5.00	X 304.00	
5.00	X 305.00	
5.00	X 306.00	
5.00	X 307.00	
5.00	X 308.00	
5.00	X 309.00	
5.00	X 310.00	
5.00	X 311.00	
5.00	X 312.00	
5.00	X 313.00	
5.00	X 314.00	
5.00	X 315.00	
5.00	X 316.00	
5.00	X 317.00	
5.00	X 318.00	
5.00	X 319.00	
5.00	X 320.00	
5.00	X 321.00	
5.00	X 322.00	
5.00	X 323.00	
5.00	X 324.00	
5.00	X 325.00	
5.00	X 326.00	
5.00	X 327.00	
5.00	X 328.00	
5.00	X 329.00	
5.00	X 330.00	
5.00	X 331.00	
5.00	X 332.00	
5.00	X 333.00	
5.00	X 334.00	
5.00	X 335.00	
5.00	X 336.00	
5.00	X 337.00	
5.00	X 338.00	
5.00	X 339.00	
5.00	X 340.00	
5.00	X 341.00	
5.00	X 342.00	
5.00	X 343.00	
5.00	X 344.00	
5.00	X 345.00	
5.00	X 346.00	
5.00	X 347.00	
5.00	X 348.00	
5.00	X 349.00	
5.00	X 350.00	
5.00	X 351.00	
5.00	X 352.00	
5.00	X 353.00	
5.00	X 354.00	
5.00	X 355.00	
5.00	X 356.00	

CROSS SECTION (mm)	INSIDE DIAMETER (mm)	SIZE CROSS REF.
5.00	X 357.00	
5.00	X 358.00	
5.00	X 359.00	
5.00	X 360.00	
5.00	X 361.00	
5.00	X 362.00	
5.00	X 363.00	
5.00	X 364.00	
5.00	X 365.00	
5.00	X 366.00	
5.00	X 367.00	
5.00	X 368.00	
5.00	X 369.00	
5.00	X 370.00	
5.00	X 371.00	
5.00	X 372.00	
5.00	X 373.00	
5.00	X 374.00	
5.00	X 375.00	
5.00	X 376.00	
5.00	X 377.00	
5.00	X 378.00	
5.00	X 379.00	
5.00	X 380.00	
5.00	X 381.00	
5.00	X 382.00	
5.00	X 383.00	
5.00	X 384.00	
5.00	X 385.00	
5.00	X 386.00	
5.00	X 387.00	
5.00	X 388.00	
5.00	X 389.00	
5.00	X 390.00	
5.00	X 391.00	
5.00	X 392.00	
5.00	X 393.00	
5.00	X 394.00	
5.00	X 395.00	
5.00	X 396.00	
5.00	X 397.00	
5.00	X 398.00	
5.00	X 399.00	
5.00	X 400.00	
5.00	X 415.00	
5.00	X 460.00	
5.00	X 470.00	
5.30	X 40.00	
5.30	X 41.20	
5.30	X 41.40	
5.30	X 42.50	
5.30	X 43.70	

Metric O-Rings (Continued)

(Metric O-Ring Tolerances – Page 40)

CROSS SECTION (mm)	INSIDE DIAMETER (mm)	SIZE CROSS REF.
5.30 X	45.00	
5.30 X	46.20	
5.30 X	47.50	
5.30 X	48.70	
5.30 X	50.00	
5.30 X	51.50	
5.30 X	53.00	
5.30 X	54.40	
5.30 X	54.50	
5.30 X	56.00	
5.30 X	58.00	
5.30 X	60.00	
5.30 X	61.50	
5.30 X	63.00	
5.30 X	65.00	
5.30 X	67.00	
5.30 X	69.00	
5.30 X	71.00	
5.30 X	73.00	
5.30 X	75.00	
5.30 X	77.50	
5.30 X	80.00	
5.30 X	82.50	
5.30 X	85.00	
5.30 X	87.50	
5.30 X	90.00	
5.30 X	92.50	
5.30 X	95.00	
5.30 X	97.50	
5.30 X	100.00	
5.30 X	103.00	
5.30 X	106.00	
5.30 X	109.00	
5.30 X	112.00	
5.30 X	115.00	
5.30 X	118.00	
5.30 X	122.00	
5.30 X	125.00	
5.30 X	128.00	
5.30 X	132.00	
5.30 X	136.00	
5.30 X	140.00	
5.30 X	145.00	
5.30 X	150.00	
5.30 X	155.00	
5.30 X	160.00	
5.30 X	165.00	
5.30 X	170.00	
5.30 X	175.00	
5.30 X	180.00	
5.30 X	185.00	
5.30 X	190.00	
5.30 X	195.00	

CROSS SECTION (mm)	INSIDE DIAMETER (mm)	SIZE CROSS REF.
5.30 X	200.00	
5.33 X	10.46	-309
5.33 X	12.07	-310
5.33 X	13.64	-311
5.33 X	15.24	-312
5.33 X	16.81	-313
5.33 X	18.42	-314
5.33 X	19.99	-315
5.33 X	21.59	-316
5.33 X	23.16	-317
5.33 X	24.77	-318
5.33 X	26.34	-319
5.33 X	27.94	-320
5.33 X	29.51	-321
5.33 X	31.12	-322
5.33 X	32.69	-323
5.33 X	34.29	-324
5.33 X	37.47	-325
5.33 X	40.64	-326
5.33 X	43.82	-327
5.33 X	46.99	-328
5.33 X	50.17	-329
5.33 X	53.34	-330
5.33 X	56.52	-331
5.33 X	59.69	-332
5.33 X	62.87	-333
5.33 X	66.04	-334
5.33 X	69.22	-335
5.33 X	72.39	-336
5.33 X	74.63	BS619
5.33 X	75.57	-337
5.33 X	78.74	-338
5.33 X	79.73	BS620
5.33 X	81.92	-339
5.33 X	85.09	-340
5.33 X	88.27	-341
5.33 X	89.69	BS621
5.33 X	91.44	-342
5.33 X	94.62	-343
5.33 X	97.79	-344
5.33 X	100.00	BS622
5.33 X	100.97	-345
5.33 X	104.14	-346
5.33 X	107.32	-347
5.33 X	109.54	BS623
5.33 X	110.49	-348
5.33 X	113.67	-349
5.33 X	116.84	-350
5.33 X	117.48	BS860
5.33 X	120.02	-351
5.33 X	120.65	BS861
5.33 X	123.19	-352

CROSS SECTION (mm)	INSIDE DIAMETER (mm)	SIZE CROSS REF.
5.33 X	123.83	BS862
5.33 X	126.37	-353
5.33 X	127.00	BS863
5.33 X	129.54	-354
5.33 X	130.18	BS864
5.33 X	132.72	-355
5.33 X	133.35	BS865
5.33 X	135.89	-356
5.33 X	136.53	BS866
5.33 X	139.07	-357
5.33 X	139.70	BS867
5.33 X	142.24	-358
5.33 X	142.88	BS868
5.33 X	145.42	-359
5.33 X	146.05	BS869
5.33 X	148.59	-360
5.33 X	149.23	BS870
5.33 X	151.77	-361
5.33 X	155.00	BS644
5.33 X	158.12	-362
5.33 X	161.30	BS645
5.33 X	164.47	-363
5.33 X	167.70	BS646
5.33 X	170.82	-364
5.33 X	174.00	BS647
5.33 X	177.17	-365
5.33 X	183.52	-366
5.33 X	189.87	-367
5.33 X	196.22	-368
5.33 X	202.57	-369
5.33 X	208.92	-370
5.33 X	215.27	-371
5.33 X	221.62	-372
5.33 X	227.97	-373
5.33 X	234.32	-374
5.33 X	240.67	-375
5.33 X	247.02	-376
5.33 X	253.37	-377
5.33 X	266.07	-378
5.33 X	278.77	-379
5.33 X	291.47	-380
5.33 X	291.69	
5.33 X	304.17	-381
5.33 X	329.57	-382
5.33 X	354.97	-383
5.33 X	380.37	-384
5.33 X	405.26	-385
5.33 X	430.66	-386
5.33 X	456.06	-387
5.33 X	481.46	-388
5.33 X	491.49	
5.33 X	506.86	-389
5.33 X	532.26	-390

CROSS SECTION (mm)	INSIDE DIAMETER (mm)	SIZE CROSS REF.
5.33 X	557.66	-391
5.33 X	582.68	-392
5.33 X	608.08	-393
5.33 X	633.48	-394
5.33 X	658.88	-395
5.33 X	702.66	
5.50 X	34.00	
5.50 X	72.00	
5.50 X	75.00	
5.50 X	145.00	
5.70 X	24.20	
5.70 X	35.20	
5.70 X	36.20	
5.70 X	37.20	
5.70 X	39.20	
5.70 X	41.20	
5.70 X	44.20	
5.70 X	44.30	
5.70 X	45.20	
5.70 X	45.30	
5.70 X	47.20	
5.70 X	47.60	P48A
5.70 X	49.20	
5.70 X	49.30	
5.70 X	49.60	P50A
5.70 X	51.20	
5.70 X	51.60	P52
5.70 X	52.20	
5.70 X	52.30	
5.70 X	52.50	
5.70 X	52.60	P53
5.70 X	53.00	
5.70 X	54.20	
5.70 X	54.30	
5.70 X	54.60	P55
5.70 X	55.20	
5.70 X	55.30	
5.70 X	55.60	P56
5.70 X	57.20	
5.70 X	57.60	P58
5.70 X	59.20	
5.70 X	59.30	
5.70 X	59.60	P60
5.70 X	59.70	
5.70 X	61.20	
5.70 X	61.60	P62
5.70 X	62.00	
5.70 X	62.20	
5.70 X	62.30	
5.70 X	62.60	P63
5.70 X	64.00	

Metric O-Rings (Continued)

(Metric O-Ring Tolerances – Page 40)

CROSS SECTION (mm)	INSIDE DIAMETER (mm)	SIZE CROSS REF.
5.70 X	64.20	
5.70 X	64.30	
5.70 X	64.60	P65
5.70 X	66.60	P67
5.70 X	67.20	
5.70 X	67.60	P68
5.70 X	69.00	
5.70 X	69.20	
5.70 X	69.30	
5.70 X	69.60	P70
5.70 X	70.20	
5.70 X	70.60	P71
5.70 X	71.20	
5.70 X	72.20	
5.70 X	72.30	
5.70 X	74.00	
5.70 X	74.20	
5.70 X	74.30	
5.70 X	74.60	P75
5.70 X	77.20	
5.70 X	79.00	
5.70 X	79.20	
5.70 X	79.30	
5.70 X	79.60	P80
5.70 X	81.20	
5.70 X	82.20	
5.70 X	84.00	
5.70 X	84.10	
5.70 X	84.20	
5.70 X	84.30	
5.70 X	84.60	P85
5.70 X	87.20	
5.70 X	89.00	
5.70 X	89.10	
5.70 X	89.20	
5.70 X	89.30	
5.70 X	89.60	P90
5.70 X	92.20	
5.70 X	94.00	
5.70 X	94.10	
5.70 X	94.20	
5.70 X	94.30	
5.70 X	94.60	P95
5.70 X	97.20	
5.70 X	99.00	
5.70 X	99.10	
5.70 X	99.20	
5.70 X	99.30	
5.70 X	99.60	P100
5.70 X	101.60	P102
5.70 X	104.00	
5.70 X	104.10	
5.70 X	104.20	

CROSS SECTION (mm)	INSIDE DIAMETER (mm)	SIZE CROSS REF.
5.70 X	104.30	
5.70 X	104.60	P105
5.70 X	109.00	
5.70 X	109.10	
5.70 X	109.20	
5.70 X	109.30	
5.70 X	109.60	P110
5.70 X	111.60	P112
5.70 X	114.00	
5.70 X	114.20	
5.70 X	114.30	
5.70 X	114.60	P115
5.70 X	119.00	
5.70 X	119.20	
5.70 X	119.30	
5.70 X	119.50	
5.70 X	119.60	P120
5.70 X	124.00	
5.70 X	124.30	
5.70 X	124.60	P125
5.70 X	125.30	
5.70 X	129.20	
5.70 X	129.30	
5.70 X	129.60	P130
5.70 X	131.60	P132
5.70 X	132.20	
5.70 X	133.20	
5.70 X	134.20	
5.70 X	134.30	
5.70 X	134.60	P135
5.70 X	139.20	
5.70 X	139.30	
5.70 X	139.60	P140
5.70 X	144.20	
5.70 X	144.30	
5.70 X	144.60	P145
5.70 X	149.20	
5.70 X	149.30	G150
5.70 X	149.60	P150
5.70 X	154.30	G155
5.70 X	159.30	G160
5.70 X	164.20	
5.70 X	164.30	G165
5.70 X	168.00	
5.70 X	169.30	G170
5.70 X	174.20	
5.70 X	174.30	G175
5.70 X	179.30	G180
5.70 X	184.30	G185
5.70 X	189.20	
5.70 X	189.30	G190
5.70 X	194.20	
5.70 X	194.30	G195

CROSS SECTION (mm)	INSIDE DIAMETER (mm)	SIZE CROSS REF.
5.70 X	199.20	
5.70 X	199.30	G200
5.70 X	204.20	
5.70 X	209.20	
5.70 X	209.30	G210
5.70 X	219.30	G220
5.70 X	229.30	G230
5.70 X	234.30	
5.70 X	239.30	G240
5.70 X	249.30	G250
5.70 X	259.30	G260
5.70 X	269.30	G270
5.70 X	279.30	G280
5.70 X	289.20	
5.70 X	289.30	G290
5.70 X	299.30	G300
5.70 X	319.30	
5.70 X	329.30	
5.70 X	339.30	
5.70 X	349.30	
5.70 X	359.30	
5.70 X	379.30	
5.70 X	399.30	
5.70 X	419.30	
5.70 X	439.30	
5.70 X	449.20	
5.70 X	459.30	
5.70 X	479.30	
5.70 X	499.30	
5.70 X	519.30	
5.70 X	529.30	
5.70 X	594.00	
5.70 X	594.30	
5.70 X	725.00	
5.80 X	11.70	
5.80 X	218.00	
6.00 X	6.00	
6.00 X	7.00	
6.00 X	9.00	
6.00 X	10.00	
6.00 X	11.00	
6.00 X	12.00	
6.00 X	13.00	
6.00 X	14.00	
6.00 X	15.00	
6.00 X	16.00	
6.00 X	18.00	
6.00 X	19.00	
6.00 X	19.50	
6.00 X	20.00	
6.00 X	21.00	

CROSS SECTION (mm)	INSIDE DIAMETER (mm)	SIZE CROSS REF.
6.00 X	22.00	
6.00 X	23.00	
6.00 X	23.50	
6.00 X	24.00	
6.00 X	25.00	
6.00 X	26.00	
6.00 X	27.00	
6.00 X	28.00	
6.00 X	29.00	
6.00 X	30.00	
6.00 X	31.00	
6.00 X	32.00	
6.00 X	33.00	
6.00 X	34.00	
6.00 X	35.00	
6.00 X	36.00	
6.00 X	37.00	
6.00 X	38.00	
6.00 X	39.00	
6.00 X	39.50	
6.00 X	40.00	
6.00 X	41.00	
6.00 X	41.50	
6.00 X	42.00	
6.00 X	43.00	
6.00 X	44.00	
6.00 X	44.50	
6.00 X	45.00	
6.00 X	46.00	
6.00 X	47.00	
6.00 X	48.00	
6.00 X	49.00	
6.00 X	50.00	
6.00 X	51.00	
6.00 X	52.00	
6.00 X	53.00	
6.00 X	54.00	
6.00 X	55.00	
6.00 X	56.00	
6.00 X	57.00	
6.00 X	58.00	
6.00 X	59.50	
6.00 X	60.00	
6.00 X	61.00	
6.00 X	62.00	
6.00 X	63.00	
6.00 X	64.00	
6.00 X	65.00	
6.00 X	66.00	
6.00 X	67.00	
6.00 X	68.00	
6.00 X	69.00	
6.00 X	70.00	

Metric O-Rings (Continued)

(Metric O-Ring Tolerances – Page 40)

CROSS SECTION (mm)	INSIDE DIAMETER (mm)	SIZE CROSS REF.
6.00 X	72.00	
6.00 X	73.00	
6.00 X	74.00	
6.00 X	75.00	
6.00 X	76.00	
6.00 X	78.00	
6.00 X	78.50	
6.00 X	79.00	
6.00 X	80.00	
6.00 X	81.00	
6.00 X	81.50	
6.00 X	84.00	
6.00 X	85.00	
6.00 X	86.00	
6.00 X	88.00	
6.00 X	90.00	
6.00 X	92.00	
6.00 X	93.00	
6.00 X	95.00	
6.00 X	96.00	
6.00 X	98.00	
6.00 X	99.00	
6.00 X	100.00	
6.00 X	101.00	
6.00 X	103.00	
6.00 X	104.00	
6.00 X	104.50	
6.00 X	105.00	
6.00 X	106.00	
6.00 X	108.00	
6.00 X	110.00	
6.00 X	111.00	
6.00 X	112.00	
6.00 X	114.00	
6.00 X	115.00	
6.00 X	118.00	
6.00 X	120.00	
6.00 X	122.00	
6.00 X	123.00	
6.00 X	124.00	
6.00 X	125.00	
6.00 X	126.00	
6.00 X	128.00	
6.00 X	130.00	
6.00 X	132.00	
6.00 X	134.00	
6.00 X	135.00	
6.00 X	136.00	
6.00 X	138.00	
6.00 X	139.20	
6.00 X	140.00	
6.00 X	142.00	
6.00 X	143.00	

CROSS SECTION (mm)	INSIDE DIAMETER (mm)	SIZE CROSS REF.
6.00 X	145.00	
6.00 X	146.00	
6.00 X	148.00	
6.00 X	150.00	
6.00 X	153.00	
6.00 X	154.00	
6.00 X	155.00	
6.00 X	155.50	
6.00 X	156.00	
6.00 X	157.00	
6.00 X	158.00	
6.00 X	159.00	
6.00 X	160.00	
6.00 X	162.00	
6.00 X	165.00	
6.00 X	166.00	
6.00 X	169.00	
6.00 X	170.00	
6.00 X	172.00	
6.00 X	175.00	
6.00 X	176.00	
6.00 X	180.00	
6.00 X	182.00	
6.00 X	184.00	
6.00 X	185.00	
6.00 X	188.00	
6.00 X	190.00	
6.00 X	191.20	
6.00 X	193.00	
6.00 X	195.00	
6.00 X	196.00	
6.00 X	198.00	
6.00 X	200.00	
6.00 X	201.00	
6.00 X	202.00	
6.00 X	203.00	
6.00 X	203.50	
6.00 X	204.00	
6.00 X	205.00	
6.00 X	206.00	
6.00 X	208.00	
6.00 X	210.00	
6.00 X	212.00	
6.00 X	215.00	
6.00 X	216.00	
6.00 X	217.00	
6.00 X	218.00	
6.00 X	220.00	
6.00 X	221.00	
6.00 X	222.50	V225
6.00 X	225.00	
6.00 X	226.00	
6.00 X	229.00	

CROSS SECTION (mm)	INSIDE DIAMETER (mm)	SIZE CROSS REF.
6.00 X	230.00	
6.00 X	235.00	
6.00 X	236.00	
6.00 X	237.00	
6.00 X	237.50	
6.00 X	238.00	
6.00 X	240.00	
6.00 X	242.00	
6.00 X	244.00	
6.00 X	247.00	
6.00 X	249.00	
6.00 X	250.00	
6.00 X	258.00	
6.00 X	259.00	
6.00 X	260.00	
6.00 X	262.00	
6.00 X	265.00	
6.00 X	266.00	
6.00 X	270.00	
6.00 X	272.00	V275
6.00 X	278.00	
6.00 X	280.00	
6.00 X	284.00	
6.00 X	285.00	
6.00 X	288.00	
6.00 X	290.00	
6.00 X	294.00	
6.00 X	295.00	
6.00 X	300.00	
6.00 X	301.00	
6.00 X	305.00	
6.00 X	310.00	
6.00 X	311.00	
6.00 X	315.00	
6.00 X	320.00	
6.00 X	321.50	V325
6.00 X	324.00	
6.00 X	325.00	
6.00 X	330.00	
6.00 X	333.00	
6.00 X	335.00	
6.00 X	338.00	
6.00 X	340.00	
6.00 X	345.00	
6.00 X	347.00	
6.00 X	348.00	
6.00 X	350.00	
6.00 X	355.00	
6.00 X	358.00	
6.00 X	360.00	
6.00 X	365.00	
6.00 X	368.00	
6.00 X	370.00	

CROSS SECTION (mm)	INSIDE DIAMETER (mm)	SIZE CROSS REF.
6.00 X	375.00	
6.00 X	376.00	V380
6.00 X	380.00	
6.00 X	385.00	
6.00 X	386.00	
6.00 X	388.00	
6.00 X	389.00	
6.00 X	390.00	
6.00 X	392.00	
6.00 X	394.00	
6.00 X	395.00	
6.00 X	398.00	
6.00 X	400.00	
6.00 X	415.00	
6.00 X	422.00	
6.00 X	425.50	V430
6.00 X	429.00	
6.00 X	446.00	
6.00 X	448.00	
6.00 X	450.00	
6.00 X	453.00	
6.00 X	470.00	
6.00 X	478.00	
6.00 X	480.00	
6.00 X	483.00	
6.00 X	486.00	
6.00 X	489.00	
6.00 X	500.00	
6.00 X	504.00	
6.00 X	505.00	
6.00 X	508.00	
6.00 X	510.00	
6.00 X	516.00	
6.00 X	530.00	
6.00 X	540.00	
6.00 X	544.00	
6.00 X	549.00	
6.00 X	552.00	
6.00 X	555.00	
6.00 X	560.00	
6.00 X	569.00	
6.00 X	575.00	
6.00 X	579.00	
6.20 X	422.20	
6.35 X	610.00	
6.50 X	50.00	
6.50 X	57.00	
6.90 X	422.20	

Metric O-Rings (Continued)

(Metric O-Ring Tolerances – Page 40)

CROSS SECTION (mm)	INSIDE DIAMETER (mm)	SIZE CROSS REF.
6.99 X	34.29	-400
6.99 X	37.46	-401
6.99 X	40.64	-402
6.99 X	43.81	-403
6.99 X	46.99	-404
6.99 X	50.16	-405
6.99 X	53.34	-406
6.99 X	56.51	-407
6.99 X	59.69	-408
6.99 X	62.86	-409
6.99 X	66.04	-410
6.99 X	69.21	-411
6.99 X	72.39	-412
6.99 X	75.56	-413
6.99 X	78.74	-414
6.99 X	81.91	-415
6.99 X	85.09	-416
6.99 X	88.26	-417
6.99 X	91.44	-418
6.99 X	94.61	-419
6.99 X	97.79	-420
6.99 X	100.96	-421
6.99 X	104.14	-422
6.99 X	107.31	-423
6.99 X	110.49	-424
6.99 X	113.67	-425
6.99 X	114.70	BS624
6.99 X	116.84	-426
6.99 X	120.02	-427
6.99 X	123.19	-428
6.99 X	124.60	BS625
6.99 X	126.37	-429
6.99 X	129.54	-430
6.99 X	132.72	-431
6.99 X	134.50	BS626
6.99 X	135.89	-432
6.99 X	139.07	-433
6.99 X	142.24	-434
6.99 X	145.42	-435
6.99 X	148.59	-436
6.99 X	151.77	-437
6.99 X	155.60	BS872
6.99 X	158.12	-438
6.99 X	159.50	BS627
6.99 X	161.90	BS874
6.99 X	164.47	-439
6.99 X	166.70	BS628
6.99 X	168.30	BS876
6.99 X	170.82	-440
6.99 X	174.60	BS878
6.99 X	177.17	-441
6.99 X	181.00	BS880
6.99 X	183.52	-442

CROSS SECTION (mm)	INSIDE DIAMETER (mm)	SIZE CROSS REF.
6.99 X	187.30	BS882
6.99 X	189.87	-443
6.99 X	193.70	BS884
6.99 X	196.22	-444
6.99 X	200.00	BS886
6.99 X	202.57	-445
6.99 X	208.92	BS674
6.99 X	215.27	-446
6.99 X	221.62	BS676
6.99 X	227.97	-447
6.99 X	234.32	BS678
6.99 X	240.67	-448
6.99 X	247.00	BS680
6.99 X	253.37	-449
6.99 X	259.70	BS682
6.99 X	266.07	-450
6.99 X	272.40	BS684
6.99 X	278.77	-451
6.99 X	285.10	BS686
6.99 X	291.47	-452
6.99 X	297.80	BS688
6.99 X	304.17	-453
6.99 X	310.50	BS648
6.99 X	316.87	-454
6.99 X	323.20	BS649
6.99 X	329.57	-455
6.99 X	335.90	BS650
6.99 X	342.27	-456
6.99 X	354.97	-457
6.99 X	367.67	-458
6.99 X	380.37	-459
6.99 X	393.07	-460
6.99 X	405.26	-461
6.99 X	417.96	-462
6.99 X	430.66	-463
6.99 X	443.36	-464
6.99 X	456.06	-465
6.99 X	468.76	-466
6.99 X	481.46	-467
6.99 X	494.16	-468
6.99 X	506.86	-469
6.99 X	532.26	-470
6.99 X	557.66	-471
6.99 X	582.68	-472
6.99 X	608.08	-473
6.99 X	633.48	-474
6.99 X	658.88	-475
6.99 X	675.16	
7.00 X	12.00	
7.00 X	54.00	
7.00 X	60.00	

CROSS SECTION (mm)	INSIDE DIAMETER (mm)	SIZE CROSS REF.
7.00 X	70.00	
7.00 X	75.00	
7.00 X	82.00	
7.00 X	90.00	
7.00 X	95.00	
7.00 X	105.00	
7.00 X	110.00	
7.00 X	192.00	
7.00 X	206.00	
7.00 X	212.00	
7.00 X	218.00	
7.00 X	224.00	
7.00 X	230.00	
7.00 X	236.00	
7.00 X	243.00	
7.00 X	250.00	
7.00 X	250.37	
7.00 X	258.00	
7.00 X	265.00	
7.00 X	272.00	
7.00 X	280.00	
7.00 X	290.00	
7.00 X	300.00	
7.00 X	307.00	
7.00 X	315.00	
7.00 X	325.00	
7.00 X	335.00	
7.00 X	345.00	
7.00 X	355.00	
7.00 X	360.00	
7.00 X	365.00	
7.00 X	375.00	
7.00 X	387.00	
7.00 X	400.00	
7.00 X	412.00	
7.00 X	425.00	
7.00 X	437.00	
7.00 X	450.00	
7.00 X	457.20	
7.00 X	462.00	
7.00 X	475.00	
7.00 X	487.00	
7.00 X	490.00	
7.00 X	494.67	
7.00 X	500.00	
7.00 X	515.00	
7.00 X	530.00	
7.00 X	545.00	
7.00 X	545.47	
7.00 X	560.00	
7.00 X	580.00	
7.00 X	596.27	
7.00 X	600.00	

CROSS SECTION (mm)	INSIDE DIAMETER (mm)	SIZE CROSS REF.
7.00 X	615.00	
7.00 X	630.00	
7.00 X	647.07	
7.00 X	650.00	
7.00 X	670.00	
7.00 X	699.00	
7.00 X	724.00	
7.00 X	730.50	
7.00 X	745.00	
7.00 X	760.00	
7.00 X	880.00	
7.50 X	75.00	
8.00 X	25.00	
8.00 X	42.00	
8.00 X	57.00	
8.00 X	60.00	
8.00 X	97.00	
8.00 X	100.00	
8.00 X	108.00	
8.00 X	114.00	
8.00 X	150.00	
8.00 X	160.00	
8.00 X	180.00	
8.00 X	195.00	
8.00 X	216.00	
8.00 X	226.00	
8.00 X	230.00	
8.00 X	240.00	
8.00 X	242.00	
8.00 X	260.00	
8.00 X	265.00	
8.00 X	280.00	
8.00 X	310.00	
8.00 X	326.00	
8.00 X	330.00	
8.00 X	350.00	
8.00 X	360.00	
8.00 X	400.00	
8.00 X	425.00	
8.00 X	450.00	
8.00 X	460.00	
8.00 X	490.00	
8.00 X	500.00	
8.00 X	520.00	
8.00 X	630.00	
8.00 X	638.00	
8.00 X	800.00	
8.30 X	125.00	
8.40 X	144.10	

Metric O-Rings (Continued)

(Metric O-Ring Tolerances – Page 40)

CROSS SECTION (mm)	INSIDE DIAMETER (mm)	SIZE CROSS REF.
8.40 X	149.10	
8.40 X	149.50	P150A
8.40 X	154.10	
8.40 X	154.50	P155
8.40 X	159.10	
8.40 X	159.50	P160
8.40 X	164.10	
8.40 X	164.50	P165
8.40 X	169.10	
8.40 X	169.50	P170
8.40 X	174.10	
8.40 X	174.50	P175
8.40 X	179.10	
8.40 X	179.50	P180
8.40 X	184.10	
8.40 X	184.50	P185
8.40 X	189.10	
8.40 X	189.50	P190
8.40 X	194.10	
8.40 X	194.50	P195
8.40 X	199.10	
8.40 X	199.50	P200
8.40 X	204.10	
8.40 X	204.50	P205
8.40 X	208.50	P209
8.40 X	209.10	
8.40 X	209.50	P210
8.40 X	214.50	P215
8.40 X	219.10	
8.40 X	219.50	P220
8.40 X	224.50	P225
8.40 X	229.10	
8.40 X	229.50	P230
8.40 X	234.10	
8.40 X	234.50	P235
8.40 X	239.10	
8.40 X	239.50	P240
8.40 X	244.50	P245
8.40 X	249.10	
8.40 X	249.50	P250
8.40 X	254.50	P255
8.40 X	259.50	P260
8.40 X	264.50	P265
8.40 X	269.50	P270
8.40 X	274.50	P275
8.40 X	279.50	P280
8.40 X	284.50	P285
8.40 X	289.50	P290
8.40 X	294.50	P295
8.40 X	299.50	P300
8.40 X	304.00	
8.40 X	314.50	P315
8.40 X	319.50	P320

CROSS SECTION (mm)	INSIDE DIAMETER (mm)	SIZE CROSS REF.
8.40 X	334.50	P335
8.40 X	339.50	P340
8.40 X	354.50	P355
8.40 X	359.50	P360
8.40 X	374.50	P375
8.40 X	375.00	
8.40 X	384.50	P385
8.40 X	399.50	P400
9.00 X	75.00	
9.00 X	84.00	
9.00 X	205.00	
9.00 X	316.00	
9.00 X	335.00	
9.00 X	360.00	
9.00 X	402.00	
9.00 X	451.00	
9.00 X	480.00	
9.00 X	545.00	
10.00 X	35.00	
10.00 X	38.00	
10.00 X	92.00	
10.00 X	105.00	
10.00 X	120.00	
10.00 X	140.00	
10.00 X	160.00	
10.00 X	195.00	
10.00 X	205.00	
10.00 X	228.00	
10.00 X	264.00	
10.00 X	270.00	
10.00 X	280.00	
10.00 X	292.00	
10.00 X	300.00	
10.00 X	315.00	
10.00 X	325.00	
10.00 X	330.00	
10.00 X	340.00	
10.00 X	360.00	
10.00 X	380.00	
10.00 X	450.00	
10.00 X	475.00	V480
10.00 X	524.50	V530
10.00 X	579.00	V585
10.00 X	633.50	V640
10.00 X	683.00	V690
10.00 X	700.00	
10.00 X	732.50	V740
10.00 X	782.00	V790
10.00 X	836.50	V845
10.00 X	1044.00	V1055

Batch Numbers
and
Cure Dates
are provided upon request
on your
O-Ring Orders.

Japanese Industrial Standards Dimensional Data

P Series						G Series					
JIS NO.	CROSS SECTION (mm)	INSIDE DIA. (mm)	JIS NO.	CROSS SECTION (mm)	INSIDE DIA. (mm)	JIS NO.	CROSS SECTION (mm)	INSIDE DIA. (mm)	JIS NO.	CROSS SECTION (mm)	INSIDE DIA. (mm)
P3	1.90	X 2.80	P48	3.50	X 47.70	P195	8.40	X 194.50	G25	3.10	24.40
P4	1.90	X 3.80	P49	3.50	X 48.70	P200	8.40	X 199.50	G30	3.10	29.40
P5	1.90	X 4.80	P50	3.50	X 49.70	P205	8.40	X 204.50	G35	3.10	34.40
P6	1.90	X 5.80	P48A	5.70	X 47.60	P209	8.40	X 208.50	G40	3.10	39.40
P7	1.90	X 6.80	P50A	5.70	X 49.60	P210	8.40	X 209.50	G45	3.10	44.40
P8	1.90	X 7.80	P52	5.70	X 51.60	P215	8.40	X 214.50	G50	3.10	49.40
P9	1.90	X 8.80	P53	5.70	X 52.60	P220	8.40	X 219.50	G55	3.10	54.40
P10	1.90	X 9.80	P55	5.70	X 54.60	P225	8.40	X 224.50	G60	3.10	59.40
P10A	2.40	X 9.80	P56	5.70	X 55.60	P230	8.40	X 229.50	G65	3.10	64.40
P11	2.40	X 10.80	P58	5.70	X 57.60	P235	8.40	X 234.50	G70	3.10	69.40
P11.2	2.40	X 11.00	P60	5.70	X 59.60	P240	8.40	X 239.50	G75	3.10	74.40
P12	2.40	X 11.80	P62	5.70	X 61.60	P245	8.40	X 244.50	G80	3.10	79.40
P12.5	2.40	X 12.30	P63	5.70	X 62.60	P250	8.40	X 249.50	G85	3.10	84.40
P14	2.40	X 13.80	P65	5.70	X 64.60	P255	8.40	X 254.50	G90	3.10	89.40
P15	2.40	X 14.80	P67	5.70	X 66.60	P260	8.40	X 259.50	G95	3.10	94.40
P16	2.40	X 15.80	P70	5.70	X 69.60	P265	8.40	X 264.50	G100	3.10	99.40
P18	2.40	X 17.80	P71	5.70	X 70.60	P270	8.40	X 269.50	G105	3.10	104.40
P20	2.40	X 19.80	P75	5.70	X 74.60	P275	8.40	X 274.50	G110	3.10	109.40
P21	2.40	X 20.80	P80	5.70	X 79.60	P280	8.40	X 279.50	G115	3.10	114.40
P22	2.40	X 21.80	P85	5.70	X 84.60	P285	8.40	X 284.50	G120	3.10	119.40
P22A	3.50	X 21.70	P90	5.70	X 89.60	P290	8.40	X 289.50	G125	3.10	124.40
P22.4	3.50	X 22.10	P95	5.70	X 94.60	P295	8.40	X 294.50	G130	3.10	129.40
P24	3.50	X 23.70	P100	5.70	X 99.60	P300	8.40	X 299.50	G135	3.10	134.40
P25	3.50	X 24.70	P102	5.70	X 101.60	P315	8.40	X 314.50	G140	3.10	139.40
P25.5	3.50	X 25.20	P105	5.70	X 104.60	P320	8.40	X 319.50	G145	3.10	144.40
P26	3.50	X 25.70	P110	5.70	X 109.60	P335	8.40	X 334.50	G150	5.70	149.30
P28	3.50	X 27.70	P112	5.70	X 111.60	P340	8.40	X 339.50	G155	5.70	154.30
P29	3.50	X 28.70	P115	5.70	X 114.60	P355	8.40	X 354.50	G160	5.70	159.30
P29.5	3.50	X 29.20	P120	5.70	X 119.60	P360	8.40	X 359.50	G165	5.70	164.30
P30	3.50	X 29.70	P125	5.70	X 124.60	P375	8.40	X 374.50	G170	5.70	169.30
P31	3.50	X 30.70	P130	5.70	X 129.60	P385	8.40	X 384.50	G175	5.70	174.30
P31.5	3.50	X 31.20	P132	5.70	X 131.60	P400	8.40	X 399.50	G180	5.70	179.30
P32	3.50	X 31.70	P135	5.70	X 134.60				G185	5.70	184.30
P34	3.50	X 33.70	P140	5.70	X 139.60				G190	5.70	189.30
P35	3.50	X 34.70	P145	5.70	X 144.60				G195	5.70	194.30
P35.5	3.50	X 35.20	P150	5.70	X 149.60				G200	5.70	199.30
P36	3.50	X 35.70	P150A	8.40	X 149.50				G210	5.70	209.30
P38	3.50	X 37.70	P155	8.40	X 154.50				G220	5.70	219.30
P39	3.50	X 38.70	P160	8.40	X 159.50				G230	5.70	229.30
P40	3.50	X 39.70	P165	8.40	X 164.50				G240	5.70	239.30
P41	3.50	X 40.70	P170	8.40	X 169.50				G250	5.70	249.30
P42	3.50	X 41.70	P175	8.40	X 174.50				G260	5.70	259.30
P44	3.50	X 43.70	P180	8.40	X 179.50				G270	5.70	269.30
P45	3.50	X 44.70	P185	8.40	X 184.50				G280	5.70	279.30
P46	3.50	X 45.70	P190	8.40	X 189.50				G290	5.70	289.30
									G300	5.70	299.30

Japanese Industrial Standards Dimensional Data (Continued)

S Series						V Series		
JIS NO.	CROSS SECTION (mm)	INSIDE DIA. (mm)	JIS NO.	CROSS SECTION (mm)	INSIDE DIA. (mm)	JIS NO.	CROSS SECTION (mm)	INSIDE DIA. (mm)
S3	1.50	X 2.50	S45	2.00	X 44.50	V15	4.00	X 14.50
S4	1.50	X 3.50	S46	2.00	X 45.50	V24	4.00	X 23.50
S5	1.50	X 4.50	S48	2.00	X 47.50	V34	4.00	X 33.50
S6	1.50	X 5.50	S50	2.00	X 49.50	V40	4.00	X 39.50
S7	1.50	X 6.50	S53	2.00	X 52.50	V55	4.00	X 54.50
S8	1.50	X 7.50	S55	2.00	X 54.50	V70	4.00	X 69.00
S9	1.50	X 8.50	S56	2.00	X 55.50	V85	4.00	X 84.00
S10	1.50	X 9.50	S60	2.00	X 59.50	V100	4.00	X 99.00
S11.2	1.50	X 10.70	S63	2.00	X 62.50	V120	4.00	X 119.00
S12	1.50	X 11.50	S65	2.00	X 64.50	V150	4.00	X 148.50
S12.5	1.50	X 12.00	S67	2.00	X 66.50	V175	4.00	X 173.00
S14	1.50	X 13.50	S70	2.00	X 69.50	V225	6.00	X 222.50
S15	1.50	X 14.50	S71	2.00	X 70.50	V275	6.00	X 272.00
S16	1.50	X 15.50	S75	2.00	X 74.50	V325	6.00	X 321.50
S18	1.50	X 17.50	S80	2.00	X 79.50	V380	6.00	X 376.00
S20	1.50	X 19.50	S85	2.00	X 84.50	V430	6.00	X 425.50
S22	1.50	X 21.50	S90	2.00	X 89.50	V480	10.00	X 475.00
S22.4	2.00	X 21.90	S95	2.00	X 94.50	V530	10.00	X 524.50
S24	2.00	X 23.50	S100	2.00	X 99.50	V585	10.00	X 579.00
S25	2.00	X 24.50	S105	2.00	X 104.50	V640	10.00	X 633.50
S26	2.00	X 25.50	S110	2.00	X 109.50	V690	10.00	X 683.00
S28	2.00	X 27.50	S112	2.00	X 111.50	V740	10.00	X 732.50
S29	2.00	X 28.50	S115	2.00	X 114.50	V790	10.00	X 782.00
S30	2.00	X 29.50	S120	2.00	X 119.50	V845	10.00	X 836.50
S31.5	2.00	X 31.00	S125	2.00	X 124.50	V950	10.00	X 940.50
S32	2.00	X 31.50	S130	2.00	X 129.50	V1055	10.00	X 1044.00
S34	2.00	X 33.50	S132	2.00	X 131.50			
S35	2.00	X 34.50	S135	2.00	X 134.50			
S35.5	2.00	X 35.00	S140	2.00	X 139.50			
S36	2.00	X 35.50	S145	2.00	X 144.50			
S38	2.00	X 37.50	S150	2.00	X 149.50			
S39	2.00	X 38.50						
S40	2.00	X 39.50						
S42	2.00	X 41.50						
S43	2.00	X 42.50						
S44	2.00	X 43.50						

Metric O-Ring Tolerances
(DIN 3771, Part 1 and ISO 3601/1)

INSIDE DIAMETER (mm)	TOLERANCE (mm)
1.80 – 2.79	± 0.13
2.80 – 4.86	± 0.14
4.87 – 6.69	± 0.15
6.70 – 8.75	± 0.16
8.76 – 10.59	± 0.17
10.5 – 11.79	± 0.18
11.8 – 14.99	± 0.19
15.0 – 16.99	± 0.20
17.0 – 18.99	± 0.21
19.0 – 21.19	± 0.22
21.2 – 22.39	± 0.23
22.4 – 24.99	± 0.24
25.0 – 25.79	± 0.25
25.8 – 27.99	± 0.26
28.0 – 29.99	± 0.28
30.0 – 31.49	± 0.29
31.5 – 32.49	± 0.31
32.5 – 34.49	± 0.32
34.5 – 35.49	± 0.33
35.5 – 36.49	± 0.34
36.5 – 37.49	± 0.35
37.5 – 38.59	± 0.36
38.7 – 39.99	± 0.37
40.0 – 41.19	± 0.38
41.2 – 42.49	± 0.39
42.5 – 43.69	± 0.40
43.7 – 44.99	± 0.41
45.0 – 46.19	± 0.42
46.2 – 47.49	± 0.43
47.5 – 48.69	± 0.44
48.7 – 49.99	± 0.45
50.0 – 51.49	± 0.46
51.5 – 52.99	± 0.47
53.0 – 54.49	± 0.48
54.5 – 55.99	± 0.50
56.0 – 57.99	± 0.51
58.0 – 59.99	± 0.52
60.0 – 61.49	± 0.54
61.5 – 62.99	± 0.55
63.0 – 64.99	± 0.58
6.50 – 68.99	± 0.58
67.0 – 68.99	± 0.59
69.0 – 70.99	± 0.61
71.0 – 72.99	± 0.63
73.0 – 74.99	± 0.64

INSIDE DIAMETER (mm)	TOLERANCE (mm)
75.0 – 77.49	± 0.66
77.5 – 79.99	± 0.67
80.0 – 82.49	± 0.69
82.5 – 84.99	± 0.71
85.0 – 87.49	± 0.73
87.5 – 89.99	± 0.75
90.0 – 92.49	± 0.77
92.5 – 94.99	± 0.79
95.0 – 97.49	± 0.81
97.5 – 99.99	± 0.83
100 – 102.9	± 0.84
103 – 105.9	± 0.87
106 – 108.9	± 0.89
109 – 111.9	± 0.91
112 – 114.9	± 0.93
115 – 117.9	± 0.95
118 – 121.9	± 0.97
122 – 124.9	± 1.00
125 – 127.9	± 1.03
128 – 131.9	± 1.05
132 – 135.9	± 1.08
136 – 139.9	± 1.10
140 – 144.9	± 1.13
145 – 149.9	± 1.17
150 – 154.9	± 1.20
155 – 159.9	± 1.24
160 – 164.9	± 1.27
165 – 169.9	± 1.31
170 – 174.9	± 1.34
175 – 179.9	± 1.38
180 – 184.9	± 1.41
185 – 189.9	± 1.44
190 – 194.9	± 1.48
195 – 199.9	± 1.51
200 – 205.9	± 1.55
206 – 211.9	± 1.59
212 – 217.9	± 1.63
218 – 223.9	± 1.67
224 – 229.9	± 1.71
230 – 235.9	± 1.75
238 – 242.9	± 1.79
243 – 249.9	± 1.83
250 – 257.9	± 1.88
258 – 264.9	± 1.93
265 – 271.9	± 1.98

INSIDE DIAMETER (mm)	TOLERANCE (mm)
272 – 279.9	± 2.02
280 – 289.9	± 2.08
290 – 299.9	± 2.14
300 – 306.9	± 2.21
307 – 314.9	± 2.25
315 – 324.9	± 2.30
325 – 334.9	± 2.37
335 – 344.9	± 2.43
345 – 354.9	± 2.49
355 – 364.9	± 2.56
365 – 374.9	± 2.62
375 – 386.9	± 2.68
387 – 399.9	± 2.78
400 – 411.9	± 2.84
412 – 424.9	± 2.91
425 – 436.9	± 2.99
437 – 449.9	± 3.07
450 – 461.9	± 3.15
462 – 474.9	± 3.22
475 – 486.9	± 3.30
487 – 499.9	± 3.37
500 – 514.9	± 3.45
515 – 529.9	± 3.54
530 – 544.9	± 3.63
545 – 559.9	± 3.72
560 – 579.9	± 3.81
580 – 599.9	± 3.93
600 – 614.9	± 4.05
615 – 629.9	± 4.13
630 – 649.9	± 4.22
650 – 669.9	± 4.34
670 – 689.9	± 4.46
≥ 690	± 0.65%

CROSS SECTION (mm)	TOLERANCE (mm)
≤ 2.62	± 0.08
2.63 – 3.00	± 0.09
3.01 – 4.50	± 0.10
4.51 – 5.50	± 0.13
5.51 – 7.50	± 0.15
7.51 – 8.50	± 0.18
8.51 – 10.0	± 0.20

Q-Ring Sizes and Dimensions

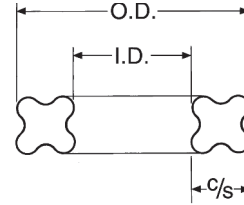

AS568 SERIES	NOMINAL SIZE			ACTUAL
Q-DASH NO.	I.D.	O.D.	C/S	I.D.
-004 TO -050 Cross Section Diameters — .070 ± .003 inches				
*-001	1/32	X 3/32	X 1/32	.029
*-002	3/64	X 9/64	X 1/32	.042
*-003	1/16	X 3/16	X 1/16	.056
-004	5/64	X 13/64	X 1/16	.070
-005	3/32	X 7/32	X 1/16	.101
-006	1/8	X 1/4	X 1/16	.114
-007	5/32	X 9/32	X 1/16	.145
-008	3/16	X 5/16	X 1/16	.176
-009	7/32	X 11/32	X 1/16	.208
-010	1/4	X 3/8	X 1/16	.239
-011	5/16	X 7/16	X 1/16	.301
-012	3/8	X 1/2	X 1/16	.364
-013	7/16	X 9/16	X 1/16	.426
-014	1/2	X 5/8	X 1/16	.489
-015	9/16	X 11/16	X 1/16	.551
-016	5/8	X 3/4	X 1/16	.614
-017	11/16	X 13/16	X 1/16	.676
-018	3/4	X 7/8	X 1/16	.739
-019	13/16	X 15/16	X 1/16	.801
-020	7/8	X 1	X 1/16	.864
-021	15/16	X 1-1/16	X 1/16	.926
-022	1	X 1-1/8	X 1/16	.989
-023	1-1/16	X 1-3/16	X 1/16	1.051
-024	1-1/8	X 1-1/4	X 1/16	1.114
-025	1-3/16	X 1-5/16	X 1/16	1.176
-026	1-1/4	X 1-3/8	X 1/16	1.239
-027	1-5/16	X 1-7/16	X 1/16	1.301
-028	1-3/8	X 1-1/2	X 1/16	1.364
-029	1-1/2	X 1-5/8	X 1/16	1.489
-030	1-5/8	X 1-3/4	X 1/16	1.614
-031	1-3/4	X 1-7/8	X 1/16	1.739
-032	1-7/8	X 2	X 1/16	1.864
-033	2	X 2-1/8	X 1/16	1.989
-034	2-1/8	X 2-1/4	X 1/16	2.114
-035	2-1/4	X 2-3/8	X 1/16	2.239
-036	2-3/8	X 2-1/2	X 1/16	2.364
-037	2-1/2	X 2-5/8	X 1/16	2.489
-038	2-5/8	X 2-3/4	X 1/16	2.614
-039	2-3/4	X 2-7/8	X 1/16	2.739
-040	2-7/8	X 3	X 1/16	2.864

AS568 SERIES	NOMINAL SIZE			ACTUAL
Q-DASH NO.	I.D.	O.D.	C/S	I.D.
-004 TO -050 Cross Section Diameters — .070 ± .003 inches				
-041	3	X 3-1/8	X 1/16	2.989
-042	3-1/4	X 3-3/8	X 1/16	3.239
-043	3-1/2	X 3-5/8	X 1/16	3.489
-044	3-3/4	X 3-7/8	X 1/16	3.739
-045	4	X 4-1/8	X 1/16	3.989
-046	4-1/4	X 4-3/8	X 1/16	4.239
-047	4-1/2	X 4-5/8	X 1/16	4.489
-048	4-3/4	X 4-7/8	X 1/16	4.739
-049	5	X 5-1/8	X 1/16	4.989
-050	5-1/4	X 5-3/8	X 1/16	5.239
-102 to -178 Cross Section Diameters - .103 ± .003 inches				
-102	1/16	X 1/4	X 3/32	.049
-103	3/32	X 9/32	X 3/32	.081
-104	1/8	X 5/16	X 3/32	.112
-105	5/32	X 11/32	X 3/32	.143
-106	3/16	X 3/8	X 3/32	.174
-107	7/32	X 13/32	X 3/32	.206
-108	1/4	X 7/16	X 3/32	.237
-109	5/16	X 1/2	X 3/32	.299
-110	3/8	X 9/16	X 3/32	.362
-111	7/16	X 5/8	X 3/32	.424
-112	1/2	X 11/16	X 3/32	.487
-113	9/16	X 3/4	X 3/32	.549
-114	5/8	X 13/16	X 3/32	.612
-115	11/16	X 7/8	X 3/32	.674
-116	3/4	X 15/16	X 3/32	.737
-117	13/16	X 1	X 3/32	.799
-118	7/8	X 1-1/16	X 3/32	.862
-119	15/16	X 1-1/8	X 3/32	.924
-120	1	X 1-3/16	X 3/32	.987
-121	1-1/16	X 1-1/4	X 3/32	1.049
-122	1-1/8	X 1-5/16	X 3/32	1.112
-123	1-3/16	X 1-3/8	X 3/32	1.174
-124	1-1/4	X 1-7/16	X 3/32	1.237
-125	1-5/16	X 1-1/2	X 3/32	1.299
-126	1-3/8	X 1-9/16	X 3/32	1.362
-127	1-7/16	X 1-5/8	X 3/32	1.424
-128	1-1/2	X 1-11/16	X 3/32	1.487
-129	1-9/16	X 1-3/4	X 3/32	1.549
-130	1-5/8	X 1-13/16	X 3/32	1.612
-131	1-11/16	X 1-7/8	X 3/32	1.674
-132	1-3/4	X 1-15/16	X 3/32	1.737
-133	1-13/16	X 2	X 3/32	1.799
-134	1-7/8	X 2-1/16	X 3/32	1.862
-135	1-15/16	X 2-1/8	X 3/32	1.925

* Cross Section Diameter:
 - 001 - .040 + .003 in./1.02 + .08 mm.
 - 002 - .050 + .003 in./1.27 + .08 mm.
 - 003 - .060 + .003 in./1.52 + .08 mm.

Q-Ring Sizes and Dimensions (Continued)

AS568 SERIES	NOMINAL SIZE			ACTUAL
Q-DASH NO.	I.D.	O.D.	C/S	I.D.
-102 TO -178 Cross Section Diameters — .103 ± .003 inches				
-136	2	X 2-3/16	X 3/32	1.987
-137	2-1/16	X 2-1/4	X 3/32	2.050
-138	2-1/8	X 2-5/16	X 3/32	2.112
-139	2-3/16	X 2-3/8	X 3/32	2.175
-140	2-1/4	X 2-7/16	X 3/32	2.237
-141	2-5/16	X 2-1/2	X 3/32	2.300
-142	2-3/8	X 2-9/16	X 3/32	2.362
-143	2-7/16	X 2-5/8	X 3/32	2.425
-144	2-1/2	X 2-11/16	X 3/32	2.487
-145	2-9/16	X 2-3/4	X 3/32	2.550
-146	2-5/8	X 2-13/16	X 3/32	2.612
-147	2-11/16	X 2-7/8	X 3/32	2.675
-148	2-3/4	X 2-15/16	X 3/32	2.737
-149	2-13/16	X 3	X 3/32	2.800
-150	2-7/8	X 3-1/16	X 3/32	2.862
-151	3	X 3-3/16	X 3/32	2.987
-152	3-1/4	X 3-7/16	X 3/32	3.237
-153	3-1/2	X 3-11/16	X 3/32	3.487
-154	3-3/4	X 3-15/16	X 3/32	3.737
-155	4	X 4-3/16	X 3/32	3.987
-156	4-1/4	X 4-7/16	X 3/32	4.237
-157	4-1/2	X 4-11/16	X 3/32	4.487
-158	4-3/4	X 4-15/16	X 3/32	4.737
-159	5	X 5-3/16	X 3/32	4.987
-160	5-1/4	X 5-7/16	X 3/32	5.237
-161	5-1/2	X 5-11/16	X 3/32	5.487
-162	5-3/4	X 5-15/16	X 3/32	5.737
-163	6	X 6-3/16	X 3/32	5.987
-164	6-1/4	X 6-7/16	X 3/32	6.237
-165	6-1/2	X 6-11/16	X 3/32	6.487
-166	6-3/4	X 6-15/16	X 3/32	6.737
-167	7	X 7-3/16	X 3/32	6.987
-168	7-1/4	X 7-7/16	X 3/32	7.237
-169	7-1/2	X 7-11/16	X 3/32	7.487
-170	7-3/4	X 7-15/16	X 3/32	7.737
-171	8	X 8-3/16	X 3/32	7.987
-172	8-1/4	X 8-7/16	X 3/32	8.237
-173	8-1/2	X 8-11/16	X 3/32	8.487
-174	8-3/4	X 8-15/16	X 3/32	8.737
-175	9	X 9-3/16	X 3/32	8.987
-176	9-1/4	X 9-7/16	X 3/32	9.237
-177	9-1/2	X 9-11/16	X 3/32	9.487
-178	9-3/4	X 9-15/16	X 3/32	9.737
-201 to -284 Cross Section Diameter - .139 ± .004 inches				
-201	3/16	X 7/16	X 1/8	.171
-202	1/4	X 1/2	X 1/8	.234
-203	5/16	X 9/16	X 1/8	.296
-204	3/8	X 5/8	X 1/8	.359
-205	7/16	X 11/16	X 1/8	.421
-206	1/2	X 3/4	X 1/8	.484
-207	9/16	X 1-13/16	X 1/8	.546
-208	5/8	X 7/8	X 1/8	.609
-209	11/16	X 15/16	X 1/8	.671
-210	3/4	X 1	X 1/8	.734

AS568 SERIES	NOMINAL SIZE			ACTUAL
Q-DASH NO.	I.D.	O.D.	C/S	I.D.
-201 TO -284 Cross Section Diameters — .139 ± .004 inches				
-211	13/16	X 1-1/16	X 1/8	.796
-212	7/8	X 1-1/8	X 1/8	.859
-213	15/16	X 1-3/16	X 1/8	.921
-214	1	X 1-1/4	X 1/8	.984
-215	1-1/16	X 1-5/16	X 1/8	1.046
-216	1-1/8	X 1-3/8	X 1/8	1.109
-217	1-3/16	X 1-7/16	X 1/8	1.171
-218	1-1/4	X 1-1/2	X 1/8	1.234
-219	1-5/16	X 1-9/16	X 1/8	1.296
-220	1-3/8	X 1-5/8	X 1/8	1.359
-221	1-7/16	X 1-11/16	X 1/8	1.421
-222	1-1/2	X 1-3/4	X 1/8	1.609
-223	1-5/8	X 1-7/8	X 1/8	1.609
-224	1-3/4	X 2	X 1/8	1.734
-225	1-7/8	X 2-1/8	X 1/8	1.859
-226	2	X 2-1/4	X 1/8	1.984
-227	2-1/8	X 2-3/8	X 1/8	2.109
-228	2-1/4	X 2-1/2	X 1/8	2.234
-229	2-3/8	X 2-5/8	X 1/8	2.359
-230	2-1/2	X 2-3/4	X 1/8	2.484
-231	2-5/8	X 2-7/8	X 1/8	2.609
-232	2-3/4	X 3	X 1/8	2.734
-233	2-7/8	X 3-1/8	X 1/8	2.859
-234	3	X 3-1/4	X 1/8	2.984
-235	3-1/8	X 3-3/8	X 1/8	3.109
-236	3-1/4	X 3-1/2	X 1/8	3.234
-237	3-3/8	X 3-5/8	X 1/8	3.359
-238	3-1/2	X 3-3/4	X 1/8	3.484
-239	3-5/8	X 3-7/8	X 1/8	3.609
-240	3-3/4	X 4	X 1/8	3.734
-241	3-7/8	X 4-1/8	X 1/8	3.859
-242	4	X 4-1/4	X 1/8	3.984
-243	4-1/8	X 4-3/8	X 1/8	4.109
-244	4-1/4	X 4-1/2	X 1/8	4.234
-245	4-3/8	X 4-5/8	X 1/8	4.359
-246	4-1/2	X 4-3/4	X 1/8	4.484
-247	4-5/8	X 4-7/8	X 1/8	4.609
-248	4-3/4	X 5	X 1/8	4.734
-249	4-7/8	X 5-1/8	X 1/8	4.859
-250	5	X 5-1/4	X 1/8	4.984
-251	5-1/8	X 5-3/8	X 1/8	5.109
-252	5-1/4	X 5-1/2	X 1/8	5.234
-253	5-3/8	X 5-5/8	X 1/8	5.359
-254	5-1/2	X 5-3/4	X 1/8	5.484
-255	5-5/8	X 5-7/8	X 1/8	5.609
-256	5-3/4	X 6	X 1/8	5.734
-257	5-7/8	X 6-1/8	X 1/8	5.859
-258	6	X 6-1/4	X 1/8	5.984
-259	6-1/4	X 6-1/2	X 1/8	6.234
-260	6-1/2	X 6-3/4	X 1/8	6.484
-261	6-3/4	X 7	X 1/8	6.734
-262	7	X 7-1/4	X 1/8	6.984
-263	7-1/4	X 7-1/2	X 1/8	7.234
-264	7-1/2	X 7-3/4	X 1/8	7.484
-265	7-3/4	X 8	X 1/8	7.734

Q-Ring Sizes and Dimensions (Continued)

AS568 SERIES	NOMINAL SIZE			ACTUAL	AS568 SERIES	NOMINAL SIZE			ACTUAL
Q-DASH NO.	I.D.	O.D.	C/S	I.D.	Q-DASH NO.	I.D.	O.D.	C/S	I.D.
-201 TO -284 Cross Section Diameters — .139 ± .004 inches					-309 TO -395 Cross Section Diameters — .210 ± .005 inches				
-266	8	X 8-1/4	X 1/8	7.984	-341	3-1/2	X 3-7/8	X 3/16	3.475
-267	8-1/4	X 8-1/2	X 1/8	8.234	-342	3-5/8	X 4	X 3/16	3.600
-268	8-1/2	X 8-3/4	X 1/8	8.484	-343	3-3/4	X 4-1/8	X 3/16	3.725
-269	8-3/4	X 9	X 1/8	8.734	-344	3-7/8	X 4-1/16	X 3/16	3.850
-270	9	X 9-1/4	X 1/8	8.984	-345	4	X 4-3/8	X 3/16	3.975
-271	9-1/4	X 9-1/2	X 1/8	9.234	-346	4-1/8	X 4-1/2	X 3/16	4.100
-272	9-1/2	X 9-3/4	X 1/8	9.484	-347	4-1/4	X 4-5/8	X 3/16	4.225
-273	9-3/4	X 10	X 1/8	9.734	-348	4-3/8	X 4-3/4	X 3/16	4.350
-274	10	X 10-1/4	X 1/8	9.984	-349	4-1/2	X 4-7/8	X 3/16	4.475
-275	10-1/2	X 10-3/4	X 1/8	10.484	-350	4-5/8	X 5	X 3/16	4.600
-276	11	X 11-1/4	X 1/8	10.984	-351	4-3/4	X 5-1/8	X 3/16	4.725
-277	11-1/2	X 11-3/4	X 1/8	11.484	-352	4-7/8	X 5-1/4	X 3/16	4.850
-278	12	X 12-1/4	X 1/8	11.984	-353	5	X 5-3/8	X 3/16	4.975
-279	13	X 13-1/4	X 1/8	12.984	-354	5-1/8	X 5-1/2	X 3/16	5.100
-280	14	X 14-1/4	X 1/8	13.984	-355	5-1/4	X 5-5/8	X 3/16	5.225
-281	15	X 15-1/4	X 1/8	14.984	-356	5-3/8	X 5-3/4	X 3/16	5.350
-282	16	X 16-1/4	X 1/8	15.955	-357	5-1/2	X 5-7/8	X 3/16	5.475
-283	17	X 17-1/4	X 1/8	16.955	-358	5-5/8	X 6	X 3/16	5.600
-284	18	X 18-1/4	X 1/8	17.955	-359	5-3/4	X 6-1/8	X 3/16	5.725
-309 to -395 Cross Section Diameter -.210 ± .005 inches					-360	5-7/8	X 6-1/4	X 3/16	5.850
-309	7/16	X 13/16	X 3/16	.412	-361	6	X 6-3/8	X 3/16	5.975
-310	1/2	X 7/8	X 3/16	.475	-362	6-1/4	X 6-5/8	X 3/16	6.225
-311	9/16	X 15/16	X 3/16	.537	-363	6-1/2	X 6-7/8	X 3/16	6.475
-312	5/8	X 1	X 3/16	.600	-364	6-3/4	X 7-1/8	X 3/16	6.725
-313	11/16	X 1-1/16	X 3/16	.662	-365	7	X 7-3/8	X 3/16	6.975
-314	3/4	X 1-1/8	X 3/16	.725	-366	7-1/4	X 7-5/8	X 3/16	7.225
-315	13/16	X 1-3/16	X 3/16	.787	-367	7-1/2	X 7-7/8	X 3/16	7.475
-316	7/8	X 1-1/4	X 3/16	.850	-368	7-3/4	X 8-1/8	X 3/16	7.725
-317	15/16	X 1-5/16	X 3/16	.850	-369	8	X 8-3/8	X 3/16	7.975
-318	1	X 1-3/8	X 3/16	.975	-370	8-1/4	X 8-5/8	X 3/16	8.225
-319	1-1/16	X 1-7/16	X 3/16	1.037	-371	8-1/2	X 8-7/8	X 3/16	8.475
-320	1-1/8	X 1-1/2	X 3/16	1.100	-372	8-3/4	X 9-1/8	X 3/16	8.725
-321	1-3/16	X 1-9/16	X 3/16	1.162	-373	9	X 9-3/8	X 3/16	8.975
-322	1-1/4	X 1-5/8	X 3/16	1.225	-374	9-1/4	X 9-5/8	X 3/16	9.225
-323	1-5/16	X 1-11/16	X 3/16	1.287	-375	9-1/2	X 9-7/8	X 3/16	9.475
-324	1-3/8	X 1-3/4	X 3/16	1.350	-376	9-3/4	X 10-1/8	X 3/16	9.725
-325	1-1/2	X 1-7/8	X 3/16	1.475	-377	10	X 10-3/8	X 3/16	9.975
-326	1-5/8	X 2	X 3/16	1.600	-378	10-1/2	X 10-7/8	X 3/16	10.475
-327	1-3/4	X 2-1/8	X 3/16	1.725	-379	11	X 11-3/8	X 3/16	10.975
-328	1-7/8	X 2-1/4	X 3/16	1.850	-380	11-1/2	X 11-7/8	X 3/16	11.475
-329	2	X 2-3/8	X 3/16	1.975	-381	12	X 12-3/8	X 3/16	11.975
-330	2-1/8	X 2-1/2	X 3/16	2.100	-382	13	X 13-3/8	X 3/16	12.975
-331	2-1/4	X 2-5/8	X 3/16	2.225	-383	14	X 14-3/8	X 3/16	13.975
-332	2-3/8	X 2-3/4	X 3/16	2.350	-384	15	X 15-3/8	X 3/16	14.975
-333	2-1/2	X 2-7/8	X 3/16	2.475	-385	16	X 16-3/8	X 3/16	15.955
-334	2-5/8	X 3	X 3/16	2.600	-386	17	X 17-3/8	X 3/16	16.955
-335	2-3/4	X 3-1/8	X 3/16	2.725	-387	18	X 18-3/8	X 3/16	17.955
-336	2-7/8	X 3-1/4	X 3/16	2.850	-388	19	X 19-3/8	X 3/16	18.952
-337	3	X 3-3/8	X 3/16	2.975	-389	20	X 20-3/8	X 3/16	19.952
-338	3-1/8	X 3-1/2	X 3/16	3.100	-390	21	X 21-3/8	X 3/16	20.952
-339	3-1/4	X 3-5/8	X 3/16	3.225	-391	22	X 22-3/8	X 3/16	21.952
-340	3-3/8	X 3-3/4	X 3/16	3.350	-392	23	X 23-3/8	X 3/16	22.940
					-393	24	X 24-3/8	X 3/16	23.940
					-394	25	X 25-3/8	X 3/16	24.940
					-395	26	X 26-3/8	X 3/16	25.940

Q-Ring Sizes and Dimensions (Continued)

AS568 SERIES	NOMINAL SIZE			ACTUAL
	Q-DASH NO.	I.D.	O.D.	C/S
-425 TO -475 Cross Section Diameters — .275 ± .006inches				
-425	4-1/2	X 5	X 1/4	4.475
-426	4-5/8	X 5-1/8	X 1/4	4.600
-427	4-3/4	X 5-1/4	X 1/4	4.725
-428	4-7/8	X 5-3/8	X 1/4	4.850
-429	5	X 5-1/2	X 1/4	4.975
-430	5-1/8	X 5-5/8	X 1/4	5.100
-431	5-1/4	X 5-3/4	X 1/4	5.225
-432	5-3/8	X 5-7/8	X 1/4	5.350
-433	5-1/2	X 6	X 1/4	5.475
-434	5-5/8	X 6-1/8	X 1/4	5.600
-435	5-3/4	X 6-1/4	X 1/4	5.725
-436	5-7/8	X 6-3/8	X 1/4	5.850
-437	6	X 6-1/2	X 1/4	5.975
-438	6-1/4	X 6-3/4	X 1/4	6.225
-439	6-1/2	X 7	X 1/4	6.475
-440	6-3/4	X 7-1/4	X 1/4	6.725
-441	7	X 7-1/2	X 1/4	6.975
-442	7-1/4	X 7-3/4	X 1/4	7.225
-443	7-1/2	X 8	X 1/4	7.475
-444	7-3/4	X 8-1/4	X 1/4	7.725
-445	8	X 8-1/2	X 1/4	7.975
-446	8-1/2	X 9	X 1/4	8.475
-447	9	X 9-1/2	X 1/4	8.975
-448	9-1/2	X 10	X 1/4	9.475
-449	10	X 10-1/2	X 1/4	9.975

AS568 SERIES	NOMINAL SIZE			ACTUAL
	Q-DASH NO.	I.D.	O.D.	C/S
-425 TO -475 Cross Section Diameters — .275 ± .006inches				
-450	10-1/2	X 11	X 1/4	10.475
-451	11	X 11-1/2	X 1/4	10.975
-452	11-1/2	X 12	X 1/4	11.475
-453	12	X 12-1/2	X 1/4	11.975
-454	12-1/2	X 13	X 1/4	12.475
-455	13	X 13-1/2	X 1/4	12.975
-456	13-1/2	X 14	X 1/4	13.475
-457	14	X 14-1/2	X 1/4	13.975
-458	14-1/2	X 15	X 1/4	14.475
-459	15	X 15-1/2	X 1/4	14.975
-460	15-1/2	X 16	X 1/4	15.475
-461	16	X 16-1/2	X 1/4	15.955
-462	16-1/2	X 17	X 1/4	16.455
-463	17	X 17-1/2	X 1/4	16.955
-464	17-1/2	X 18	X 1/4	17.455
-465	18	X 18-1/2	X 1/4	17.955
-466	18-1/2	X 19	X 1/4	18.455
-467	19	X 19-1/2	X 1/4	18.955
-468	19-1/2	X 20	X 1/4	19.455
-469	20	X 20-1/2	X 1/4	19.955
-470	21	X 21-1/2	X 1/4	20.955
-471	22	X 22-1/2	X 1/4	21.955
-472	23	X 23-1/2	X 1/4	22.940
-473	24	X 24-1/2	X 1/4	23.940
-474	25	X 25-1/2	X 1/4	24.940
-475	26	X 26-1/2	X 1/4	25.940

**Do You Want to
Place Orders On-Line?**

Go to www.callapg.com to find out how!

Contoured Back-Up Rings - Series 8

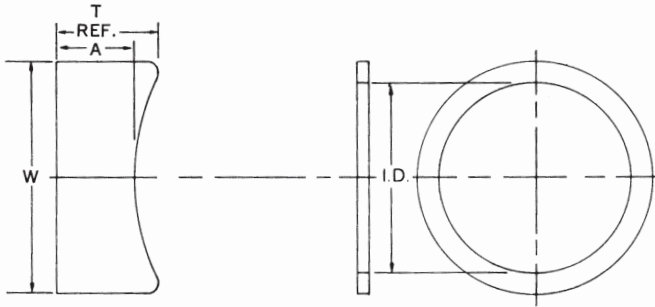

DASH NOS.	T (REF.)	A
-004 THRU -050	.049	.045 ± .003
-102 THRU -178	.053	.045 ± .003
-201 THRU -284	.050	.040 ± .003
-309 THRU -395	.076	.060 ± .004
-425 THRU -475	.117	.096 ± .005

DASH NO.	I.D.	TOL. ±	W	TOL. ±
8-004	.096	.005	.053	.003
8-005	.127	.005	.053	.003
8-006	.140	.005	.053	.003
8-007	.171	.005	.053	.003
8-008	.202	.005	.053	.003
8-009	.234	.005	.053	.003
8-010	.265	.005	.053	.003
8-011	.327	.005	.053	.003
8-012	.390	.005	.053	.003
8-013	.455	.005	.053	.003
8-014	.518	.005	.053	.003
8-015	.580	.005	.053	.003
8-016	.643	.009	.053	.003
8-017	.705	.009	.053	.003
8-018	.768	.009	.053	.003
8-019	.830	.009	.053	.003
8-020	.893	.009	.053	.003
8-021	.955	.009	.053	.003
8-022	1.018	.010	.053	.003
8-023	1.080	.010	.053	.003
8-024	1.143	.010	.053	.003
8-025	1.205	.011	.053	.003
8-026	1.268	.011	.053	.003
8-027	1.330	.011	.053	.003
8-028	1.393	.013	.053	.003
8-029	1.518	.013	.053	.003
8-030	1.643	.013	.053	.003
8-031	1.768	.015	.053	.003
8-032	1.893	.015	.053	.003
8-033	2.018	.018	.053	.003
8-034	2.143	.018	.053	.003
8-035	2.268	.018	.053	.003
8-036	2.393	.018	.053	.003
8-037	2.518	.018	.053	.003
8-038	2.643	.018	.053	.003
8-039	2.768	.020	.053	.003
8-040	2.893	.020	.053	.003
8-041	3.018	.024	.053	.003
8-042	3.268	.024	.053	.003
8-043	3.518	.024	.053	.003
8-044	3.768	.027	.053	.003
8-045	4.018	.027	.053	.003
8-046	4.268	.030	.053	.003
8-047	4.518	.030	.053	.003
8-048	4.768	.030	.053	.003
8-049	5.018	.037	.053	.003
8-050	5.268	.037	.053	.003

DASH NO.	I.D.	TOL. ±	W	TOL. ±
8-102	.077	.005	.086	.003
8-103	.109	.005	.086	.003
8-104	.140	.005	.086	.003
8-105	.171	.005	.086	.003
8-106	.202	.005	.086	.003
8-107	.234	.005	.086	.003
8-108	.265	.005	.086	.003
8-109	.327	.005	.086	.003
8-110	.390	.005	.086	.003
8-111	.452	.005	.086	.003
8-112	.515	.007	.086	.003
8-113	.577	.007	.086	.003
8-114	.640	.009	.086	.003
8-115	.702	.009	.086	.003
8-116	.765	.009	.086	.003
8-117	.831	.010	.086	.003
8-118	.893	.010	.086	.003
8-119	.956	.010	.086	.003
8-120	1.018	.010	.086	.003
8-121	1.081	.010	.086	.003
8-122	1.143	.010	.086	.003
8-123	1.206	.012	.086	.003
8-124	1.268	.012	.086	.003
8-125	1.331	.012	.086	.003
8-126	1.393	.012	.086	.003
8-127	1.456	.012	.086	.003
8-128	1.518	.012	.086	.003
8-129	1.581	.015	.086	.003
8-130	1.643	.015	.086	.003
8-131	1.706	.015	.086	.003
8-132	1.768	.015	.086	.003
8-133	1.831	.015	.086	.003
8-134	1.893	.015	.086	.003
8-135	1.956	.017	.086	.003
8-136	2.018	.017	.086	.003
8-137	2.081	.017	.086	.003
8-138	2.143	.017	.086	.003
8-139	2.206	.017	.086	.003
8-140	2.268	.017	.086	.003
8-141	2.331	.020	.086	.003
8-142	2.393	.020	.086	.003
8-143	2.456	.020	.086	.003
8-144	2.518	.020	.086	.003
8-145	2.581	.020	.086	.003
8-146	2.643	.020	.086	.003
8-147	2.706	.022	.086	.003
8-148	2.768	.022	.086	.003
8-149	2.831	.022	.086	.003
8-150	2.893	.022	.086	.003
8-151	3.018	.024	.086	.003

Contoured Back-Up Rings - Series 8 (Continued)

DASH NO.	I.D.	TOL. ±	W	TOL. ±
8-152	3.268	.024	.086	.003
8-153	3.518	.024	.086	.003
8-154	3.768	.028	.086	.003
8-155	4.018	.028	.086	.003
8-156	4.268	.030	.086	.003
8-157	4.518	.030	.086	.003
8-158	4.768	.030	.086	.003
8-159	5.018	.035	.086	.003
8-160	5.268	.035	.086	.003
8-161	5.518	.035	.086	.003
8-162	5.768	.035	.086	.003
8-163	6.018	.035	.086	.003
8-164	6.268	.040	.086	.003
8-165	6.518	.040	.086	.003
8-166	6.768	.040	.086	.003
8-167	7.018	.040	.086	.003
8-168	7.268	.045	.086	.003
8-169	7.518	.045	.086	.003
8-170	7.768	.045	.086	.003
8-171	8.018	.045	.086	.003
8-172	8.268	.050	.086	.003
8-173	8.518	.050	.086	.003
8-174	8.768	.050	.086	.003
8-175	9.018	.050	.086	.003
8-176	9.268	.050	.086	.003
8-177	9.518	.055	.086	.003
8-178	9.768	.055	.086	.003
8-201	.202	.005	.118	.004
8-202	.265	.005	.118	.004
8-203	.327	.005	.118	.004
8-204	.390	.005	.118	.004
8-205	.455	.005	.118	.004
8-206	.518	.007	.118	.004
8-207	.580	.007	.118	.004
8-208	.643	.009	.118	.004
8-209	.705	.009	.118	.004
8-210	.765	.010	.118	.004
8-211	.828	.010	.118	.004
8-212	.891	.010	.118	.004
8-213	.953	.010	.118	.004
8-214	1.016	.010	.118	.004
8-215	1.078	.010	.118	.004
8-216	1.141	.012	.118	.004
8-217	1.203	.012	.118	.004
8-218	1.266	.012	.118	.004
8-219	1.334	.012	.118	.004
8-220	1.397	.012	.118	.004
8-221	1.459	.012	.118	.004
8-222	1.522	.015	.118	.004
8-223	1.647	.015	.118	.004
8-224	1.772	.015	.118	.004
8-225	1.897	.018	.118	.004
8-226	2.022	.018	.118	.004
8-227	2.147	.018	.118	.004
8-228	2.272	.020	.118	.004
8-229	2.397	.020	.118	.004
8-230	2.522	.020	.118	.004
8-231	2.631	.020	.118	.004
8-232	2.756	.024	.118	.004
8-233	2.881	.024	.118	.004
8-234	3.006	.024	.118	.004
8-235	3.131	.024	.118	.004

DASH NO.	I.D.	TOL. ±	W	TOL. ±
8-236	3.256	.024	.118	.004
8-237	3.381	.024	.118	.004
8-238	3.506	.024	.118	.004
8-239	3.631	.028	.118	.004
8-240	3.756	.028	.118	.004
8-241	3.881	.028	.118	.004
8-242	4.006	.028	.118	.004
8-243	4.131	.028	.118	.004
8-244	4.256	.030	.118	.004
8-245	4.381	.030	.118	.004
8-246	4.506	.030	.118	.004
8-247	4.631	.030	.118	.004
8-248	4.768	.030	.118	.004
8-249	4.893	.035	.118	.004
8-250	5.018	.035	.118	.004
8-251	5.143	.035	.118	.004
8-252	5.268	.035	.118	.004
8-253	5.393	.035	.118	.004
8-254	5.518	.035	.118	.004
8-255	5.643	.035	.118	.004
8-256	5.768	.035	.118	.004
8-257	5.893	.035	.118	.004
8-258	6.018	.035	.118	.004
8-259	6.268	.040	.118	.004
8-260	6.518	.040	.118	.004
8-261	6.768	.040	.118	.004
8-262	7.018	.040	.118	.004
8-263	7.268	.045	.118	.004
8-264	7.518	.045	.118	.004
8-265	7.768	.045	.118	.004
8-266	8.018	.045	.118	.004
8-267	8.268	.050	.118	.004
8-268	8.518	.050	.118	.004
8-269	8.768	.050	.118	.004
8-270	9.018	.050	.118	.004
8-271	9.268	.055	.118	.004
8-272	9.518	.055	.118	.004
8-273	9.768	.055	.118	.004
8-274	10.018	.055	.118	.004
8-275	10.518	.055	.118	.004
8-276	11.018	.065	.118	.004
8-277	11.518	.065	.118	.004
8-278	12.018	.065	.118	.004
8-279	13.018	.065	.118	.004
8-280	14.018	.065	.118	.004
8-281	15.018	.065	.118	.004
8-282	15.989	.075	.118	.004
8-283	16.989	.080	.118	.004
8-284	17.989	.085	.118	.004
8-309	.450	.005	.183	.005
8-310	.513	.007	.183	.005
8-311	.575	.007	.183	.005
8-312	.638	.009	.183	.005
8-313	.700	.009	.183	.005
8-314	.763	.010	.183	.005
8-315	.825	.010	.183	.005
8-316	.888	.010	.183	.005
8-317	.950	.010	.183	.005
8-318	1.013	.010	.183	.005
8-319	1.075	.010	.183	.005
8-320	1.138	.012	.183	.005
8-321	1.200	.012	.183	.005
8-322	1.263	.012	.183	.005
8-323	1.316	.012	.183	.005

Contoured Back-Up Rings - Series 8 (Continued)

DASH NO.	I.D.	TOL. ±	W	TOL. ±
8-324	1.388	.012	.183	.005
8-325	1.513	.015	.183	.005
8-326	1.638	.015	.183	.005
8-327	1.763	.015	.183	.005
8-328	1.888	.015	.183	.005
8-329	2.013	.018	.183	.005
8-330	2.138	.018	.183	.005
8-331	2.263	.018	.183	.005
8-332	2.388	.018	.183	.005
8-333	2.513	.020	.183	.005
8-334	2.638	.020	.183	.005
8-335	2.763	.020	.183	.005
8-336	2.888	.020	.183	.005
8-337	3.013	.024	.183	.005
8-338	3.138	.024	.183	.005
8-339	3.263	.024	.183	.005
8-340	3.388	.024	.183	.005
8-341	3.513	.024	.183	.005
8-342	3.638	.028	.183	.005
8-343	3.763	.028	.183	.005
8-344	3.888	.028	.183	.005
8-345	4.013	.028	.183	.005
8-346	4.138	.028	.183	.005
8-347	4.263	.030	.183	.005
8-348	4.388	.030	.183	.005
8-349	4.513	.030	.183	.005
8-350	4.638	.030	.183	.005
8-351	4.763	.030	.183	.005
8-352	4.888	.030	.183	.005
8-353	5.013	.037	.183	.005
8-354	5.138	.037	.183	.005
8-355	5.263	.037	.183	.005
8-356	5.388	.037	.183	.005
8-357	5.513	.037	.183	.005
8-358	5.638	.037	.183	.005
8-359	5.763	.037	.183	.005
8-360	5.888	.037	.183	.005
8-361	6.013	.037	.183	.005
8-362	6.138	.040	.183	.005
8-363	6.263	.040	.183	.005
8-364	6.388	.040	.183	.005
8-365	6.513	.040	.183	.005
8-366	6.638	.045	.183	.005
8-367	6.763	.045	.183	.005
8-368	6.888	.045	.183	.005
8-369	7.013	.045	.183	.005
8-370	7.138	.050	.183	.005
8-371	7.263	.050	.183	.005
8-372	7.388	.050	.183	.005
8-373	7.513	.050	.183	.005
8-374	7.638	.055	.183	.005
8-375	7.763	.055	.183	.005
8-376	7.888	.055	.183	.005
8-377	8.013	.055	.183	.005
8-378	8.138	.060	.183	.005
8-379	8.263	.060	.183	.005
8-380	8.388	.065	.183	.005
8-381	8.513	.065	.183	.005
8-382	8.638	.065	.183	.005
8-383	8.763	.070	.183	.005
8-384	8.888	.070	.183	.005
8-385	9.013	.075	.183	.005
8-386	9.138	.080	.183	.005
8-387	9.263	.085	.183	.005
8-388	9.388	.090	.183	.005
8-389	9.513	.095	.183	.005
8-390	9.638	.095	.183	.005
8-391	9.763	.100	.183	.005
8-392	9.888	.105	.183	.005
8-393	10.013	.110	.183	.005
8-394	10.138	.115	.183	.005
8-395	10.263	.120	.183	.005

DASH NO.	I.D.	TOL. ±	W	TOL. ±
8-425	4.551	.033	.236	.006
8-426	4.676	.033	.236	.006
8-427	4.801	.033	.236	.006
8-428	4.926	.033	.236	.006
8-429	5.051	.037	.236	.006
8-430	5.176	.037	.236	.006
8-431	5.301	.037	.236	.006
8-432	5.426	.037	.236	.006
8-433	5.551	.037	.236	.006
8-434	5.676	.037	.236	.006
8-435	5.801	.037	.236	.006
8-436	5.926	.037	.236	.006
8-437	6.051	.037	.236	.006
8-438	6.176	.040	.236	.006
8-439	6.301	.040	.236	.006
8-440	6.426	.040	.236	.006
8-441	6.551	.040	.236	.006
8-442	6.676	.045	.236	.006
8-443	6.801	.045	.236	.006
8-444	6.926	.045	.236	.006
8-445	7.051	.045	.236	.006
8-446	7.176	.055	.236	.006
8-447	7.301	.055	.236	.006
8-448	7.426	.055	.236	.006
8-449	7.551	.055	.236	.006
8-450	7.676	.060	.236	.006
8-451	7.801	.060	.236	.006
8-452	7.926	.060	.236	.006
8-453	8.051	.060	.236	.006
8-454	8.176	.060	.236	.006
8-455	8.301	.070	.236	.006
8-456	8.426	.070	.236	.006
8-457	8.551	.070	.236	.006
8-458	8.676	.070	.236	.006
8-459	8.801	.070	.236	.006
8-460	8.926	.075	.236	.006
8-461	9.051	.075	.236	.006
8-462	9.176	.075	.236	.006
8-463	9.301	.080	.236	.006
8-464	9.426	.085	.236	.006
8-465	9.551	.085	.236	.006
8-466	9.676	.085	.236	.006
8-467	9.801	.090	.236	.006
8-468	9.926	.090	.236	.006
8-469	10.051	.096	.236	.006
8-470	10.176	.095	.236	.006
8-471	10.301	.100	.236	.006
8-472	10.426	.105	.236	.006
8-473	10.551	.110	.236	.006
8-474	10.676	.115	.236	.006
8-475	10.801	.120	.236	.006

Special Needs?
Just ask. We can help!

PTFE Spiral Back-Up Rings

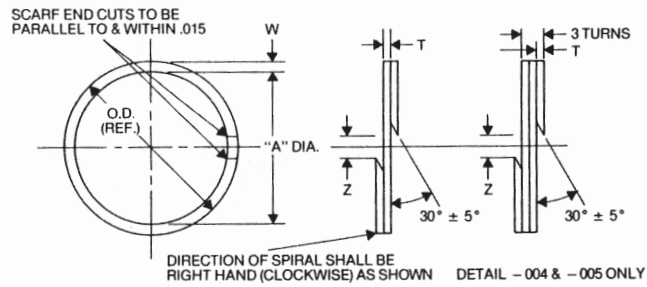

SERIES NO.	AS568 DASH NO	NOMINAL		A-DIA.	T	W	Z
		.I.D.	O.D.				
2107	-004	5/64	3/16	.078	.019	.054	
2107	-005	7/64	7/32	.110	.016	.052	
2107	-006	1/8	1/4	.125			
2107	-007	5/32	9/32	.156			
2107	-008	3/16	5/16	.188			
2107	-009	7/32	11/32	.219			
2107	-010	1/4	3/8	.250			
2107	-011	5/16	7/16	.312			
2107	-012	3/8	1/2	.375			
2107	-013	7/16	9/16	.437			
2107	-014	1/2	5/8	.500			
2107	-015	9/16	11/16	.562			
2107	-016	5/8	3/4	.625	.056	.032	
2107	-017	11/16	13/16	.687			
2107	-018	3/4	7/8	.750	.054		
2107	-019	13/16	15/16	.812			
2107	-020	7/8	1	.875	.029		
2107	-021	15/16	1-1/16	.937			
2107	-022	1	1-1/8	1.000			
2107	-023	1-1/16	1-3/16	1.062			
2107	-024	1-1/8	1-1/4	1.125			
2107	-025	1-3/16	1-5/16	1.187			
2107	-026	1-1/4	1-3/8	1.250			
2107	-027	1-5/16	1-7/16	1.312			
2107	-028	1-3/8	1-1/2	1.375			
2107	-110	3/8	9/16	.375			
2107	-111	7/16	5/8	.438			
2107	-112	1/2	11/16	.500			
2107	-113	9/16	3/4	.562			
2107	-114	5/8	13/16	.625			
2107	-115	11/16	7/8	.687			
2107	-116	3/4	15/16	.750			
2107	-117	13/16	1	.812			
2107	-118	7/8	1-1/16	.875			
2107	-119	15/16	1-1/8	.937			
2107	-120	1	1-3/16	1.000	.089		
2107	-121	1-1/16	1-1/4	1.062			
2107	-122	1-1/8	1-5/16	1.125			
2107	-123	1-3/16	1-3/8	1.187			
2107	-123	1-3/16	1-3/8	1.187			

**PTFE Spiral
Back-Up Rings (Continued)**

SERIES NO.	AS568 DASH NO.	NOMINAL		A-DIA.	T	W	Z
		I.D.	O.D.				
2107	-124	1-1/4	1-7/16	1.250			
2107	-125	1-5/16	1-1/2	1.312			
2107	-126	1-3/8	1-9/16	1.375			
2107	-127	1-7/16	1-5/8	1.437			
2107	-128	1-1/2	1-11/16	1.500			
2107	-129	1-9/16	1-3/4	1.562			
2107	-130	1-5/8	1-13/16	1.625			
2107	-131	1-11/16	1-7/8	1.687			
2107	-132	1-3/4	1-15/16	1.750			
2107	-133	1-13/16	2	1.812			
2107	-134	1-7/8	2-1/16	1.875			
2107	-135	1-15/16	2-1/8	1.937			
2107	-136	2	2-3/16	2.000			
2107	-137	2-1/16	2-1/4	2.062			
2107	-138	2-1/8	2-5/16	2.125			
2107	-139	2-3/16	2-3/8	2.187			
2107	-140	2-1/4	2-7/16	2.250			
2107	-141	2-5/16	2-1/2	2.312			
2107	-142	2-3/8	2-9/16	2.375			
2107	-143	2-7/16	2-5/8	2.437			
2107	-144	2-1/2	2-11/16	2.500			
2107	-145	2-9/16	2-3/4	2.562			
2107	-146	2-5/8	2-13/16	2.625			
2107	-147	2-11/16	2-7/8	2.687			
2107	-148	2-3/4	2-15/16	2.750			
2107	-149	2-13/16	3	2.812			
2107	-210	3/4	1	.750			
2107	-211	13/16	1-1/16	.812			
2107	-212	7/8	1-1/8	.875			
2107	-213	15/16	1-3/16	.938			
2107	-214	1	1-1/4	1.000			
2107	-215	1-1/16	1-5/16	1.062			
2107	-216	1-1/8	1-3/8	1.125			
2107	-217	1-3/16	1-7/16	1.188			
2107	-218	1-1/4	1-1/2	1.250			
2107	-219	1-5/16	1-9/16	1.312			
2107	-220	1-3/8	1-5/8	1.375			
2107	-221	1-7/16	1-5/8	1.438			
2107	-222	1-1/2	1-3/4	1.500			
2107	-223	1-5/8	1-7/8	1.625			
2107	-224	1-3/4	2	1.750			
2107	-225	1-7/8	2-1/8	1.875			
2107	-226	2	2-1/4	2.000			
2107	-227	2-1/8	2-3/8	2.125			
2107	-228	2-1/4	2-1/2	2.250			
2107	-229	2-3/8	2-5/8	2.375			
2107	-230	2-1/2	2-3/4	2.500			
2107	-231	2-5/8	2-7/8	2.625			
2107	-232	2-3/4	3	2.750			
2107	-233	2-7/8	3-1/8	2.875			
2107	-234	3	3-1/4	3.000			

**PTFE Spiral
Back-Up Rings (Continued)**

SERIES NO.	AS568 DASH NO.	NOMINAL		A-DIA.	T	W	Z
		I.D.	O.D.				
2107	-235	3-1/8	3-3/8	3.125			
2107	-236	3-1/4	3-1/2	3.250			
2107	-237	3-3/8	3-5/8	3.375			
2107	-238	3-1/2	3-3/4	3.500			
2107	-239	3-5/8	3-7/8	3.625			
2107	-240	3-3/4	4	3.750			
2107	-241	3-7/8	4-1/8	3.875			
2107	-242	4	4-1/4	4.000			
2107	-243	4-1/8	4-3/8	4.125			
2107	-244	4-1/4	4-1/2	4.250			
2107	-245	4-3/8	4-5/8	4.375			
2107	-246	4-1/2	4-3/4	4.500			
2107	-247	4-5/8	4-7/8	4.625			
2107	-248	4-3/4	5	4.750			
2107	-249	4-7/8	5-1/8	4.875			
2107	-250	5	5-1/4	5.000			
2107	-251	5-1/8	5-3/8	5.125			
2107	-252	5-1/4	5-1/2	5.250			
2107	-253	5-3/8	5-5/8	5.375			
2107	-254	5-1/2	5-3/4	5.500	.029	.121	.250
2107	-255	5-5/8	5-7/8	5.625	.025	.119	.093
2107	-256	5-3/4	6	5.750			
2107	-257	5-7/8	6-1/8	5.875			
2107	-258	6	6-1/4	6.000			
2107	-259	6-1/4	6-1/2	6.250			
2107	-260	6-1/2	6-3/4	6.500			
2107	-261	6-3/4	7	6.750			
2107	-262	7	7-1/4	7.000			
2107	-263	7-1/4	7-1/2	7.250			
2107	-264	7-1/2	7-3/4	7.500			
2107	-265	7-3/4	8	7.750			
2107	-266	8	8-1/4	8.000			
2107	-267	8-1/4	8-1/2	8.250			
2107	-268	8-1/2	8-3/4	8.500			
2107	-269	8-3/4	9	8.750			
2107	-270	9	9-1/4	9.000			
2107	-271	9-1/4	9-1/2	9.250			
2107	-272	9-1/2	9-3/4	9.500			
2107	-273	9-3/4	10	9.750			
2107	-274	10	10-1/4	10.000			
2107	-325	1-1/2	1-7/8	1.500			
2107	-326	1-5/8	2	1.625			
2107	-327	1-3/4	2-1/8	1.750			
2107	-328	1-7/8	2-1/4	1.875			
2107	-329	2	2-3/8	2.000			
2107	-330	2-1/8	2-1/2	2.125	.036	.186	.188
2107	-331	2-1/4	2-5/8	2.250	.031	.184	.062
2107	-332	2-3/8	2-3/4	2.375			
2107	-333	2-1/2	2-7/8	2.500			
2107	-334	2-5/8	3	2.625			
2107	-335	2-3/4	3-1/8	2.750			

**PTFE Spiral
Back-Up Rings (Continued)**

SERIES NO.	AS568 DASH NO.	NOMINAL		A-DIA.	T	W	Z
		I.D.	O.D.				
2107	-336	2-7/8	3-1/4	2.875			.188/.062
2107	-337	3	3-3/8	3.000			
2107	-338	3-1/8	3-1/2	3.125			
2107	-339	3-1/4	3-5/8	3.250			
2107	-340	3-3/8	3-3/4	3.375			
2107	-341	3-1/2	3-7/8	3.500			
2107	-342	3-5/8	4	3.625	.036	.186	.250
2107	-343	3-3/4	4-1/8	3.750	.031	.184	.093
2107	-344	3-7/8	4-1/4	3.875			
2107	-345	4	4-3/8	4.000			
2107	-346	4-1/8	4-1/2	4.125			
2107	-347	4-1/4	4-5/8	4.250			
2107	-348	4-3/8	4-3/4	4.375			
2107	-349	4-1/2	4-7/8	4.500			
2107	-425	4-1/2	5	4.500			
2107	-426	4-5/8	5-1/8	4.625			
2107	-427	4-3/4	5-1/4	4.750			
2107	-428	4-7/8	5-3/8	4.875			
2107	-429	5	5-1/2	5.000			
2107	-430	5-1/8	5-5/8	5.125			
2107	-431	5-1/4	5-3/4	5.250			
2107	-432	5-3/8	5-7/8	5.375			
2107	-433	5-1/2	6	5.500			
2107	-434	5-5/8	6-1/8	5.625			
2107	-435	5-3/4	6-1/4	5.750			
2107	-436	5-7/8	6-3/8	5.875			
2107	-437	6	6-1/2	6.000			
2107	-438	6-1/4	6-3/4	6.250			
2107	-439	6-1/2	7	6.500			
2107	-440	6-3/4	7-1/4	6.750			
2107	-441	7	7-1/2	7.000			
2107	-442	7-1/4	7-3/4	7.250	.052	.239	.312
2107	-443	7-1/2	8	7.500	.046	.237	.188
2107	-444	7-3/4	8-1/4	7.750			
2107	-445	8	8-1/2	8.000			
2107	-446	8-1/2	9	8.500			
2107	-447	9	9-1/2	9.000			
2107	-448	9-1/2	10	9.500			
2107	-449	10	10-1/2	10.000			
2107	-450	10-1/2	11	10.500			
2107	-451	11	11-1/2	11.000			
2107	-452	11-1/2	12	11.500			
2107	-453	12	12-1/2	12.000			
2107	-454	12-1/2	13	12.500			
2107	-455	13	13-1/2	13.000			
2107	-456	13-1/2	14	13.500			
2107	-457	14	14-1/2	14.000			
2107	-458	14-1/2	15	14.500			
2107	-459	15	15-1/2	15.000			
2107	-460	15-1/2	16	15.500			

PTFE Back-Up Rings

Solid

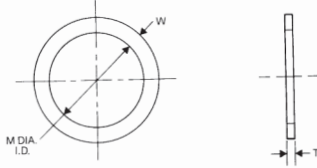

Single Turn (Split)

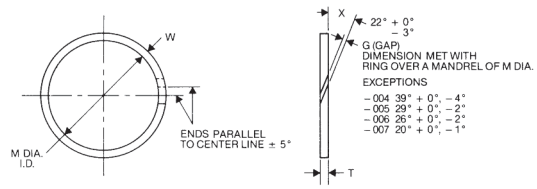

DASH NO.		M DIA.	T	W	G
004	Single Turn	.109			
005	Single Turn	.124			
006	Single Turn	.140			
007	Single Turn	.171			
008	Single Turn	.202			
009	Single Turn	.234			
010	Single Turn	.265			
011	Single Turn	.327			
012	Single Turn	.390			
013	Single Turn	.455			
014	Single Turn	.518			
015	Single Turn	.580			
016	Single Turn	.643	± .001	.052-	.005-
017	Single Turn	.705	.045	.052	.000
018	Single Turn	.768			
019	Single Turn	.830			
020	Single Turn	.898			
021	Single Turn	.960			
022	Single Turn	1.023			
023	Single Turn	1.085			
024	Single Turn	1.148			
025	Single Turn	1.210			
026	Single Turn	1.273			
027	Single Turn	1.335			
028	Single Turn	1.398			
110	Single Turn	.390			
111	Single Turn	.452			
112	Single Turn	.515			
113	Single Turn	.577			
114	Single Turn	.640			
115	Single Turn	.702			
116	Single Turn	.765			
117	Single Turn	.832			
118	Single Turn	.895			
119	Single Turn	.957			
120	Single Turn	1.020	± .001	.052-	.006-
121	Single Turn	1.082	.045	.087-	.000
122	Single Turn	1.145			
123	Single Turn	1.207			
124	Single Turn	1.270			
125	Single Turn	1.332			
126	Single Turn	1.397			
127	Single Turn	1.459			
128	Single Turn	1.522			

DASH NO.		M DIA.	T	W	G
129	Single Turn	1.584			
130	Single Turn	1.647			
131	Single Turn	1.709			
132	Single Turn	1.772			
133	Single Turn	1.834	± .001	.052-	.006-
134	Single Turn	1.897	.045	.087-	.000
135	Single Turn	1.959			
136	Single Turn	2.022			
137	Single Turn	2.084			
138	Single Turn	2.147			
139	Single Turn	2.209			
140	Solid	2.254			
141	Solid	2.317			
142	Solid	2.379			
143	Solid	2.442			
144	Solid	2.504	± .002	.050	N/A
145	Solid	2.567	± .002	± .001	
146	Solid	2.629			
147	Solid	2.692			
148	Solid	2.754			
149	Solid	2.817			
210	Single Turn	.766			
211	Single Turn	.828			
212	Single Turn	.891			
213	Single Turn	.953			
214	Single Turn	1.016			
215	Single Turn	1.078			.006-
216	Single Turn	1.141			.000
217	Single Turn	1.203			
218	Single Turn	1.266			
219	Single Turn	1.334			
220	Single Turn	1.397	± .001	.052-	.120-
221	Single Turn	1.459	.045	.118	
222	Single Turn	1.522			
223	Single Turn	1.647			
224	Single Turn	1.772			
225	Single Turn	1.897			
226	Single Turn	2.022			
227	Single Turn	2.147			.007-
228	Single Turn	2.272			.000
229	Single Turn	2.397			
230	Single Turn	2.522			

NOTE: Single Turn sizes listed are a complete listing of sizes on MS28774. Solid sizes are listed only where MS28774 does not list those sizes in the Single Turn configuration.

These Solid sizes are listed on MS27595. For sizes not included here, see "Teflon® Back-Up Rings - Extended Sizes" on page 54. Material conforms to MIL-R-8791.

PTFE Back-Up Rings (Continued)

DASH NO.		M DIA.	T	W	G				
231	Solid	2.630							
232	Solid	2.755							
233	Solid	2.880							
234	Solid	3.005							
235	Solid	3.130							
236	Solid	3.255							
237	Solid	3.380	± .002	.050	.119	N/A			
238	Solid	3.505		± .002	± .001				
239	Solid	3.630							
240	Solid	3.755							
241	Solid	3.880							
242	Solid	4.005							
243	Solid	4.130							
244	Solid	4.255							
245	Solid	4.380							
246	Solid	4.505							
247	Solid	4.630							
325	Single Turn	1.513							
326	Single Turn	1.638							
327	Single Turn	1.763							
328	Single Turn	1.888							
329	Single Turn	2.013							
330	Single Turn	2.138							
331	Single Turn	2.268							
332	Single Turn	2.393							
333	Single Turn	2.518							
334	Single Turn	2.643							
335	Single Turn	2.768							
336	Single Turn	2.893							
337	Single Turn	3.018	± .001	.075-	.184-	.007-			
338	Single Turn	3.143		.065	.182	.000			
339	Single Turn	3.273							
340	Single Turn	3.398							
341	Single Turn	3.523							
342	Single Turn	3.648							
343	Single Turn	3.773							
344	Single Turn	3.898							
345	Single Turn	4.028							
346	Single Turn	4.153							
347	Single Turn	4.278							
348	Single Turn	4.403				.075-			
349	Single Turn	4.528				.065	.184-	.007-	.000
425	Single Turn	4.551							
426	Single Turn	4.676							
427	Single Turn	4.801							
428	Single Turn	4.926							
429	Single Turn	5.051							
430	Single Turn	5.176							
431	Single Turn	5.301	± .001	.110-	.237-	.008-			
432	Single Turn	5.426		.100	.236	.000			
433	Single Turn	5.551							
434	Single Turn	5.676							
435	Single Turn	5.801							
436	Single Turn	5.926							
437	Single Turn	6.051							
438	Solid	6.252							
439	Solid	6.502							
440	Solid	6.752							
441	Solid	7.002							
442	Solid	7.252	± .002						
443	Solid	7.502							
444	Solid	7.752							
445	Solid	8.002							
446	Solid	8.502							
447	Solid	9.002							
448	Solid	9.502	± .003						
449	Solid	10.002				.108	.236	N/A	
450	Solid	10.502				± .002	± .001		
451	Solid	11.002							
452	Solid	11.502							
453	Solid	12.002	± .004						
454	Solid	12.502							
455	Solid	13.002							
456	Solid	13.502							
457	Solid	14.002							
458	Solid	14.502	± .005						
459	Solid	15.002							
460	Solid	15.502							

NOTE: Single Turn sizes listed are a complete listing of sizes on MS28774. Solid sizes are listed only where MS28774 does not list those sizes in the Single Turn configuration.

These Solid sizes are listed on MS27595. For sizes not included here, see "Teflon® Back-Up Rings - Extended Sizes" on page 54. Material conforms to MIL-R-8791.

PTFE Back-Up Rings (Extended Sizes*) (Solid)

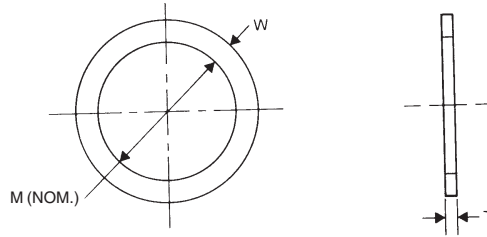

*MS28774 and MS27595 do not include all AS-568A Dash Numbers. The sizes not included on MS28774 or MS27595 are listed here in a solid configuration.

DASH NO.	M	T	W
001	1/32	.040-	.030+.001
002	3/64	.045	.040+.001
003	1/16		.047+.001
Dash Numbers 004-028 are listed on MS28774 and/or MS27595			
029	1-1/2		
030	1-5/8		
031	1-3/4		
032	1-7/8		
033	2		
034	2-1/8		
035	2-1/4		
036	2-3/8		
037	2-1/2	.052-	.054-
038	2-5/8	.045	.052
039	2-3/4		
040	2-7/8		
041	3		
042	3-1/4		
043	3-1/2		
044	3-3/4		
045	4		
046	4-1/4		
047	4-1/2		
048	4-3/4		
049	5		
050	5-1/4		
102	1/16		
103	3/32		
104	1/8		
105	5/32	.052-	.087-
106	3/16	.045	.085
107	7/32		
108	1/4		
109	5/16		

DASH NO.	M	T	W
Dash Numbers 110-149 are listed on MS28774 and/or MS27595			
150	2-7/8		
151	3		
152	3-1/4		
153	3-1/2		
154	3-3/4		
155	4		
156	4-1/4		
157	4-1/2		
158	4-3/4		
159	5		
160	5-1/4		
161	5-1/2		
162	5-3/4		
163	6	.052-	.087-
164	6-1/4	.045	.085
165	6-1/2		
166	6-3/4		
167	7		
168	7-1/4		
169	7-1/2		
170	7-3/4		
171	8		
172	8-1/4		
173	8-1/2		
174	8-3/4		
175	9		
176	9-1/4		
177	9-1/2		
178	9-3/4		
201	3/16		
202	1/4		
203	5/16		
204	3/8	.052-	.120-
205	7/16	.045	.118
206	1/2		
207	9/16		
208	5/8		
209	11/16		

DASH NO.	M	T	W
Dash Numbers 210-247 are listed on MS28774 and/or MS27595			
248	4-3/4		
249	4-7/8		
250	5		
251	5-1/8		
252	5-1/4		
253	5-3/8		
254	5-1/2		
255	5-5/8		
256	5-3/4		
257	5-7/8		
258	6		
259	6-1/4		
260	6-1/2		
261	6-3/4	.052-	.120-
262	7	.045	.118
263	7-1/4		
264	7-1/2		
265	7-3/4		
266	8		
267	8-1/4		
268	8-1/2		
269	8-3/4		
270	9		
271	9-1/4		
272	9-1/2		
273	9-3/4		
274	10		
275	10-1/2		
276	11		
277	11-1/2		
278	12		
279	13		
280	14		
281	15		
282	16		
283	17		
284	18		

**PTFE Back-Up Rings
(Extended Sizes*) (Solid) (Continued)**

DASH NO.	M	T	W
309	7/16		
310	1/2		
311	9/16		
312	5/8		
313	11/16		
314	3/4		
315	13/16	.075-	.184-
316	7/8	.065	.182
317	15/16		
318	1		
319	1-1/16		
320	1-1/8		
321	1-3/16		
322	1-1/4		
323	1-5/16		
324	1-3/8		
Dash Numbers 325-349 are listed on MS28774 and/or MS27595			
350	4-5/8		
351	4-3/4		
352	4-7/8		
353	5		
354	5-1/8		
355	5-1/4		
356	5-3/8		
357	5-1/2		
358	5-5/8		
359	5-3/4		
360	5-7/8		
361	6	.075-	.184-
362	6-1/4	.065	.182
363	6-1/2		
364	6-3/4		
365	7		
366	7-1/4		
367	7-1/2		
368	7-3/4		
369	8		
370	8-1/4		
371	8-1/2		
372	8-3/4		

DASH NO.	M	T	W
373	9		
374	9-1/4		
375	9-1/2		
376	9-3/4		
377	10		
378	10-1/2		
379	11		
380	11-1/2		
381	12		
382	13		
383	14	.075-	.184-
384	15	.065	.182
385	16		
386	17		
387	18		
388	19		
389	20		
390	21		
391	22		
392	23		
393	24		
394	25		
395	26		

DASH NO.	M	T	W
Dash Numbers 425-460 are listed on MS28774 and/or MS27595			
461	16		
462	16-1/2		
463	17		
464	17-1/2		
465	18		
466	18-1/2	.110-	.237-
467	19	.100	.236
468	19-1/2		
469	20		
470	21		
471	22		
472	23		
473	24		
474	25		
475	26		

**Have Questions?
Please give us a call.**

Leather Back-Up Rings
Series 6244
(For Use With Series 6230 "O" Rings)

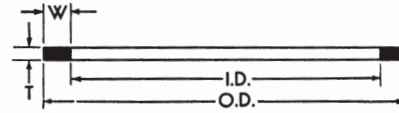

SERIES	FOR USE WITH		O.D. + 1/64"	I.D. (NOM.)	W + .010 - .005	T ± .015
	6244 -	6230 -				
1	1	223	1-7/8	1-5/8	1/8	1/16
2	2	224	2	1-3/4	1/8	1/16
3	3	225	2-1/8	1-7/8	1/8	1/16
4	4	226	2-1/4	2	1/8	1/16
5	5	227	2-3/8	2-1/8	1/8	1/16
6	6	228	2-1/2	2-1/4	1/8	1/16
7	7	229	2-5/8	2-3/8	1/8	1/16
8	8	230	2-3/4	2-1/2	1/8	1/16
9	9	231	2-7/8	2-5/8	1/8	1/16
10	10	232	3	2-3/4	1/8	1/16
11	11	233	3-1/8	2-7/8	1/8	1/16
12	12	234	3-1/4	3	1/8	1/16
13	13	235	3-3/8	3-1/8	1/8	1/16
14	14	236	3-1/2	3-1/4	1/8	1/16
15	15	237	3-5/8	3-3/8	1/8	1/16
16	16	238	3-3/4	3-1/2	1/8	1/16
17	17	239	3-7/8	3-5/8	1/8	1/16
18	18	240	4	3-3/4	1/8	1/16
19	19	241	4-1/8	3-7/8	1/8	1/16
20	20	242	4-1/4	4	1/8	1/16
21	21	243	4-3/8	4-1/8	1/8	1/16
22	22	244	4-1/2	4-1/4	1/8	1/16
23	23	245	4-5/8	4-3/8	1/8	1/16
24	24	246	4-3/4	4-1/2	1/8	1/16
25	25	247	4-7/8	4-5/8	1/8	1/16
26	26	248	5	4-3/4	1/8	1/16
27	27	249	5-1/8	4-7/8	1/8	1/16
28	28	250	5-1/4	5	1/8	1/16
29	29	251	5-3/8	5-1/8	1/8	1/16
30	30	252	5-1/2	5-1/4	1/8	1/16
31	31	253	5-5/8	5-3/8	1/8	1/16
32	32	254	5-3/4	5-1/2	1/8	1/16
33	33	255	5-7/8	5-5/8	1/8	1/16
34	34	256	6	5-3/4	1/8	1/16
35	35	257	6-1/8	5-7/8	1/8	1/16
36	36	258	6-1/4	6	1/8	1/16
37	37	259	6-1/2	6-1/4	1/8	1/16
38	38	260	6-3/4	6-1/2	1/8	1/16
39	39	261	7	6-3/4	1/8	1/16
40	40	262	7-1/4	7	1/8	1/16
41	41	263	7-1/2	7-1/4	1/8	1/16
42	42	264	7-3/4	7-1/2	1/8	1/16
43	43	265	8	7-3/4	1/8	1/16
44	44	266	8-1/4	8	1/8	1/16
45	45	267	8-1/2	8-1/4	1/8	1/16
46	46	268	8-3/4	8-1/2	1/8	1/16
47	47	269	9	8-3/4	1/8	1/16
48	48	270	9-1/4	9	1/8	1/16
49	49	271	9-1/2	9-1/4	1/8	1/16
50	50	272	9-3/4	9-1/2	1/8	1/16
51	51	273	10	9-3/4	1/8	1/16
52	52	274	10-1/4	10	1/8	1/16

**Leather Back-Up Rings
Series 6246
(For Use With Series 6227 "O" Rings)**

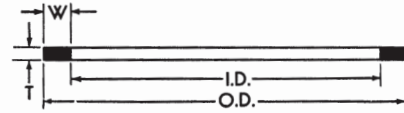

SERIES 6246 —	FOR USE WITH		O.D. ± .007	I.D. (NOM.)	W ± .007	T ± .015
	6227 —	568 —				
1	1	006	.250	1/8	.057	.062
2	2	007	.281	5/32	.057	.062
3	3	008	.312	3/16	.057	.062
4	4	009	.344	7/32	.057	.062
5	5	010	.375	1/4	.057	.062
6	6	011	.438	5/16	.057	.062
7	7	012	.500	3/8	.057	.062
8	8	110	.562	3/8	.090	.062
9	9	111	.625	7/16	.090	.062
10	10	112	.688	1/2	.090	.062
11	11	113	.750	9/16	.090	.062
12	12	114	.812	5/8	.090	.062
13	13	115	.875	11/16	.090	.062
14	14	116	.938	3/4	.090	.062

SERIES 6246 —	FOR USE WITH		O.D. ± 1/64	I.D. (NOM.)	W + .010 - .005	T ± .015
	6227 —	568 —				
15	15	210	1	3/4	.123	.062
16	16	211	1-1/16	13/16	.123	.062
17	17	212	1-1/8	7/8	.123	.062
18	18	213	1-3/16	15/16	.123	.062
19	19	214	1-1/4	1	.123	.062
20	20	215	1-5/16	1-1/16	.123	.062
21	21	216	1-3/8	1-1/8	.123	.062
22	22	217	1-7/16	1-3/16	.123	.062
23	23	218	1-1/2	1-1/4	.123	.062
24	24	219	1-9/16	1-5/16	.123	.062
25	25	220	1-5/8	1-3/8	.123	.062
26	26	221	1-11/16	1-7/16	.123	.062
27	27	222	1-3/4	1-1/2	.123	.062
28	28	325	1-7/8	1-1/2	.188	.094
29	29	326	2	1-5/8	.188	.094
30	30	327	2-1/8	1-3/4	.188	.094
31	31	328	2-1/4	1-7/8	.188	.094
32	32	329	2-3/8	2	.188	.094
33	33	330	2-1/2	2-1/8	.188	.094
34	34	331	2-5/8	2-1/4	.188	.094
35	35	332	2-3/4	2-3/8	.188	.094
36	36	333	2-7/8	2-1/2	.188	.094
37	37	334	3	2-5/8	.188	.094
38	38	335	3-1/8	2-3/4	.188	.094
39	39	336	3-1/4	2-7/8	.188	.094
40	40	337	3-3/8	3	.188	.094
41	41	338	3-1/2	3-1/8	.188	.094
42	42	339	3-5/8	3-1/4	.188	.094
43	43	340	3-3/4	3-3/8	.188	.094
44	44	341	3-7/8	3-1/2	.188	.094
45	45	342	4	3-5/8	.188	.094
46	46	343	4-1/8	3-3/4	.188	.094
47	47	344	4-1/4	3-7/8	.188	.094
48	48	345	4-3/8	4	.188	.094
49	49	346	4-1/2	4-1/8	.188	.094
50	50	347	4-5/8	4-1/4	.188	.094
51	51	348	4-3/4	4-3/8	.188	.094
52	52	349	4-7/8	4-1/2	.188	.094
53	53	426	5-1/8	4-5/8	.240	.125
54	54	427	5-1/4	4-3/4	.240	.125
55	55	428	5-3/8	4-7/8	.240	.125
56	56	429	5-1/2	5	.240	.125
57	57	430	5-5/8	5-1/8	.240	.125
58	58	431	5-3/4	5-1/4	.240	.125
59	59	432	5-7/8	5-3/8	.240	.125
60	60	433	6	5-1/2	.240	.125
61	61	434	6-1/8	5-5/8	.240	.125
62	62	435	6-1/4	5-3/4	.240	.125
63	63	436	6-3/8	5-7/8	.240	.125
64	64	437	6-1/2	6	.240	.125
65	65	438	6-3/4	6-1/4	.240	.125
66	66	439	7	6-1/2	.240	.125
67	67	440	7-1/4	6-3/4	.240	.125
68	68	441	7-1/2	7	.240	.125
69	69	442	7-3/4	7-1/4	.240	.125
70	70	443	8	7-1/2	.240	.125
71	71	444	8-1/4	7-3/4	.240	.125
72	72	445	8-1/2	8	.240	.125
73	73	446	9	8-1/2	.240	.125
74	74	447	9-1/2	9	.240	.125
75	75	448	10	9-1/2	.240	.125
76	76	449	10-1/2	10	.240	.125
77	77	450	11	10-1/2	.240	.125
78	78	451	11-1/2	11	.240	.125

All sizes in inches.

Square Cut Ring Sizes & Dimensions

DASH NO. -006 to -050

NOMINAL
CROSS SECTION
1/16 INCH

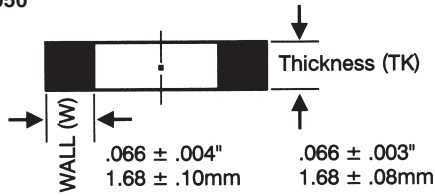

DASH NO. -106 to -146

NOMINAL
CROSS SECTION
3/32 INCH

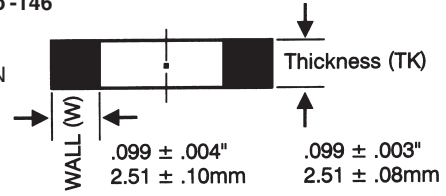

DASH NO.	NOMINAL SIZE		ACTUAL SIZE (INCH)	
	I.D.	O.D.	I.D.	TOL.±
006	1/8	1/4	.114	.005
007	5/32	9/32	.145	.005
008	3/16	5/16	.176	.005
009	7/32	11/32	.208	.005
010	1/4	3/8	.239	.005
011	5/16	7/16	.301	.005
012	3/8	1/2	.364	.005
013	7/16	9/16	.426	.005
014	1/2	5/8	.489	.005
015	9/16	11/16	.551	.007
016	5/8	3/4	.614	.009
017	11/16	13/16	.676	.009
018	3/4	7/8	.739	.009
019	1-3/16	15/16	.801	.009
020	7/8	1	.864	.009
021	15/16	1-1/16	.926	.009
022	1	1-1/8	.989	.010
023	1-1/16	1-3/16	1.051	.010
024	1-1/8	1-1/4	1.114	.010
025	1-3/16	1-5/16	1.176	.011
026	1-1/4	1-3/8	1.239	.011
027	1-5/16	1-7/16	1.301	.011
028	1-3/8	1-1/2	1.364	.013
029	1-1/2	1-5/8	1.489	.013
030	1-5/8	1-3/4	1.614	.013
031	1-3/4	1-7/8	1.739	.015
032	1-7/8	2	1.864	.015
033	2	2-1/8	1.989	.018
034	2-1/8	2-1/4	2.114	.018
035	2-1/4	2-3/8	2.239	.018
036	2-3/8	2-1/2	2.364	.018
037	2-1/2	2-5/8	2.489	.018
038	2-5/8	2-3/4	2.614	.020
039	2-3/4	2-7/8	2.739	.020
040	2-7/8	3	2.864	.020
041	3	3-1/8	2.989	.024
042	3-1/4	3-3/8	3.239	.024
043	3-1/2	3-5/8	3.489	.024
044	3-3/4	3-7/8	3.739	.027
045	4	4-1/4	3.989	.027
046	4-1/4	4-3/8	4.239	.030
047	4-1/2	4-5/8	4.489	.030
048	4-3/4	4-7/8	4.739	.030
049	5	5-1/8	4.989	.037
050	5-1/4	5-3/8	5.239	.037

DASH NO.	NOMINAL SIZE		ACTUAL SIZE (INCH)	
	I.D.	O.D.	I.D.	TOL.±
106	3/16	3/8	.174	.005
107	7/32	13/32	.206	.005
108	1/4	7/16	.237	.005
109	5/16	1/2	.299	.005
110	3/8	9/16	.362	.005
111	7/16	5/8	.424	.005
112	1/2	11/16	.487	.005
113	9/16	3/4	.549	.007
114	5/8	13/16	.612	.009
115	11/16	7/8	.674	.009
116	3/4	15/16	.737	.009
117	13/16	1	.799	.010
118	7/8	1-1/16	.862	.010
119	15/16	1-1/8	.924	.010
120	1	1-3/16	.987	.010
121	1-1/16	1-1/4	1.049	.010
122	1-1/8	1-5/16	1.112	.010
123	1-3/16	1-3/8	1.174	.012
124	1-1/4	1-7/16	1.237	.012
125	1-5/16	1-1/2	1.299	.012
126	1-3/8	1-9/16	1.362	.012
127	1-7/16	1-5/8	1.424	.012
128	1-1/2	1-11/16	1.487	.012
129	1-9/16	1-3/4	1.549	.015
130	1-5/8	1-13/16	1.612	.015
131	1-11/16	1-7/8	1.674	.015
132	1-3/4	1-15/16	1.737	.015
133	1-13/16	2	1.799	.015
.015				
134	1-7/8	2-1/16	1.862	.015
135	1-15/16	2-1/8	1.925	.017
136	2	2-3/16	1.987	.017
137	2-1/16	2-1/4	2.050	.017
138	2-1/8	2-5/16	2.112	.017
139	2-3/16	2-3/8	2.175	.017
140	2-1/4	2-7/16	2.237	.017
141	2-5/16	2-1/2	2.300	.020
142	2-3/8	2-9/16	2.362	.020
143	2-7/16	2-5/8	2.425	.020
144	2-1/2	2-11/16	2.487	.020
145	2-9/16	2-3/4	2.550	.020
146	2-5/8	2-13/16	2.612	.020

Gland dimensions on page 59.

Square Cut Ring Sizes & Dimensions (Continued)

DASH NO.-147 to -178

NOMINAL
CROSS SECTION
3/32 INCH

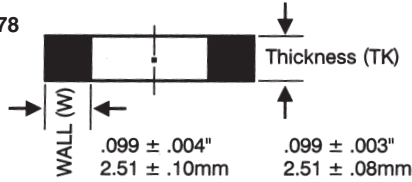

DASH NO.-201 TO -242

NOMINAL
CROSS SECTION
1/8 INCH

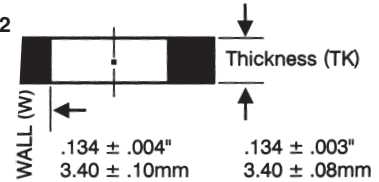

DASH NO.	NOMINAL SIZE		ACTUAL SIZE (INCH)	
	I.D.	O.D.	I.D.	TOL.±
147	2-11/16	2-7/8	2.675	.022
148	2-3/4	2-15/16	2.737	.022
149	2-13/16	3	2.800	.022
150	2-7/8	3-1/16	2.862	.022
151	3	3-3/16	2.987	.024
152	3-1/4	3-7/16	3.237	.024
153	3-1/2	3-11/16	3.487	.024
154	3-3/4	3-15/16	3.737	.028
155	4	4-3/16	3.987	.028
156	4-1/4	4-7/16	4.237	.030
157	4-1/2	4-11/16	4.487	.030
158	4-3/4	4-15/16	4.737	.030
159	5	5-3/16	4.987	.035
160	5-1/4	5-7/16	5.237	.035
161	5-1/2	5-11/16	5.487	.035
162	5-3/4	5-15/16	5.737	.035
163	6	6-3/16	5.987	.035
164	6-1/4	6-7/16	6.237	.040
165	6-1/2	6-11/16	6.487	.040
166	6-3/4	6-15/16	6.737	.040
167	7	7-3/16	6.987	.040
168	7-1/4	7-7/16	7.237	.045
169	7-1/2	7-11/16	7.487	.045
170	7-3/4	7-15/16	7.737	.045
171	8	8-3/16	7.987	.045
172	8-1/4	8-7/16	8.237	.050
173	8-1/2	8-11/16	8.487	.050
174	8-3/4	8-15/16	8.737	.050
175	9	9-3/16	8.987	.050
176	9-1/4	9-7/16	9.237	.055
177	9-1/2	9-11/16	9.487	.055
178	9-3/4	9-15/16	9.737	.055

DASH NO.	NOMINAL SIZE		ACTUAL SIZE (INCH)	
	I.D.	O.D.	I.D.	TOL.±
201	3/16	7/16	.171	.005
202	1/4	1/2	.234	.005
203	5/16	9/16	.296	.005
204	3/8	5/8	.359	.005
205	7/16	11/16	.421	.005
206	1/2	3/4	.484	.005
207	9/16	13/16	.546	.007
208	5/8	7/8	.609	.009
209	11/16	15/16	.671	.009
210	3/4	1	.734	.010
211	13/16	1-1/16	.796	.010
212	7/8	1-1/8	.859	.010
213	15/16	1-3/16	.921	.010
214	1	1-1/4	.984	.010
215	1-1/16	1-5/16	1.046	.010
216	1-1/8	1-3/8	1.109	.012
217	1-3/16	1-7/16	1.171	.012
218	1-1/4	1-1/2	1.234	.012
219	1-5/16	1-9/16	1.296	.012
220	1-3/8	1-5/8	1.359	.012
221	1-7/16	1-11/16	1.421	.012
222	1-1/2	1-3/4	1.484	.015
223	1-5/8	1-7/8	1.609	.015
224	1-3/4	2	1.734	.015
225	1-7/8	2-1/8	1.859	.018
226	2	2-1/4	1.984	.018
227	2-1/8	2-3/8	2.109	.018
228	2-1/4	2-1/2	2.234	.020
229	2-3/8	3-5/8	2.359	.020
230	2-1/2	2-3/4	2.484	.020
231	2-5/8	2-7/8	2.609	.020
232	2-3/4	3	2.734	.024
233	2-7/8	3-1/8	2.859	.024
234	3	3-1/4	2.984	.024
235	3-1/8	3-3/8	3.109	.024
236	3-1/4	3-1/2	3.234	.024
237	3-3/8	3-5/8	3.359	.024
238	3-1/2	3-3/4	3.484	.024
239	3-5/8	3-7/8	3.609	.028
240	3-3/4	4	3.734	.028
241	3-7/8	4-1/8	3.859	.028
242	4	4-1/4	3.984	.028

Gland Dimensions

DASH NO.	WIDTH	DEPTH	GAP
-006 to -050	.099" ± .005	.057" + .000 - .002	.002"
-106 to -146	.146" ± .005	.090" + .000 - .002	.0025"
-147 to -178	.146" ± .005	.090" + .000 - .002	.0025"
-201 to -242 .003"	.193" ± .005	.1225" + - .002	.000
-243 to -284	.193" ± .005	.1225" + .000 - .002	.003"
-309 to -350	.286" ± .005	.187" + .000 - .002	.0035"
-351 to -387 .0035"	.286" ± .005	.187" + .000 - .002	.000

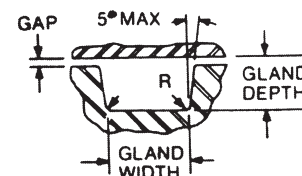

Square Cut Ring Sizes & Dimensions (Continued)

DASH NO.-243 to -284

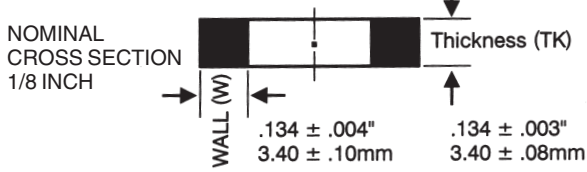

DASH NO.-309 to -350

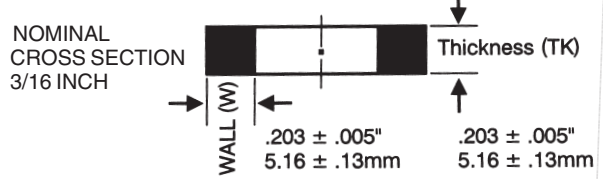

DASH NO.	NOMINAL SIZE		ACTUAL SIZE (INCH)	
	I.D.	O.D.	I.D.	TOL.±
243	4-1/8	4-3/8	4.109	.028
244	4-1/4	4-1/2	4.234	.030
245	4-3/8	4-5/8	4.359	.030
246	4-1/2	4-3/4	4.484	.030
247	4-5/8	4-7/8	4.609	.030
248	4-3/4	5	4.734	.030
249	4-7/8	5-1/8	4.859	.035
250	5	5-1/4	4.984	.035
251	5-1/8	5-3/8	5.109	.035
252	5-1/4	5-1/2	5.234	.035
253	5-3/8	5-5/8	5.359	.035
254	5-1/2	5-3/4	5.484	.035
255	5-5/8	5-7/8	5.609	.035
256	5-3/4	6	5.734	.035
257	5-7/8	6-1/8	5.859	.035
258	6	6-1/4	5.984	.035
259	6-1/4	6-1/2	6.234	.040
260	6-1/2	6-3/4	6.484	.040
261	6-3/4	7	6.734	.040
262	7	7-1/4	6.984	.040
263	7-1/4	7-1/2	7.234	.045
264	7-1/2	7-3/4	7.484	.045
265	7-3/4	8	7.734	.045
266	8	8-1/4	7.984	.045
267	8-1/4	8-1/2	8.234	.050
268	8-1/2	8-3/4	8.484	.050
269	8-3/4	9	8.734	.050
270	9	9-1/4	8.894	.050
271	9-1/4	9-1/2	9.234	.055
272	9-1/2	9-3/4	9.484	.055
273	9-3/4	10	9.734	.055
274	10	10-1/4	9.984	.055
275	10-1/2	10-3/4	10.484	.055
276	11	11-1/4	10.984	.065
277	11-1/2	11-3/4	11.484	.065
278	12	12-1/4	11.984	.065
279	13	13-1/4	12.984	.065
280	14	14-1/4	13.984	.065
281	15	15-1/4	14.984	.065
282	16	16-1/4	15.955	.075
283	17	17-1/4	16.955	.080
284	18	18-1/4	17.955	.085

DASH NO.	NOMINAL SIZE		ACTUAL SIZE (INCH)	
	I.D.	O.D.	I.D.	TOL.±
309	7/16	13/16	.412	.005
310	1/2	7/8	.475	.005
311	9/16	15/16	.537	.007
312	5/8	1	.600	.009
313	11/16	1-1/16	.662	.009
314	3/4	1-1/8	.725	.010
315	13/16	1-3/16	.787	.010
316	7/8	1-1/4	.850	.010
317	15/16	1-5/16	.912	.010
318	1	1-3/8	.975	.010
319	1-1/16	1-7/16	1.037	.010
320	1-1/8	1-1/2	1.100	.012
321	1-3/16	1-9/16	1.162	.012
322	1-1/4	1-5/8	1.225	.012
323	1-5/16	1-11/16	1.287	.012
324	1-3/8	1-3/4	1.350	.012
325	1-1/2	1-7/8	1.475	.015
326	1-5/8	2	1.600	.015
327	1-3/4	2-1/8	1.725	.015
328	1-7/8	2-1/4	1.850	.015
329	2	2-3/8	1.975	.018
330	2-1/8	2-1/2	2.100	.018
331	2-1/4	2-5/8	2.225	.018
332	2-3/8	2-3/4	2.350	.018
333	2-1/2	2-7/8	2.475	.020
334	2-5/8	3	2.600	.020
335	2-3/4	3-1/8	2.725	.020
336	2-7/8	3-1/4	2.850	.020
337	3	3-3/8	2.975	.024
338	3-1/8	3-1/2	3.100	.024
339	3-1/4	3-5/8	3.225	.024
340	3-3/8	3-3/4	3.350	.024
341	3-1/2	3-7/8	3.475	.024
342	3-5/8	4	3.600	.028
343	3-3/4	4-1/8	3.725	.028
344	3-7/8	4-1/4	3.850	.028
345	4	4-3/8	3.975	.028
346	4-1/8	4-1/2	4.100	.028
347	4-1/4	4-5/8	4.225	.030
348	4-3/8	4-3/4	4.350	.030
349	4-1/2	4-7/8	4.475	.030
350	4-5/8	5	4.600	.030

Gland dimensions on page 59.

Square Cut Ring Sizes & Dimensions (Continued)

DASH NO.-351 to -387

NOMINAL
CROSS SECTION
3/16 INCH

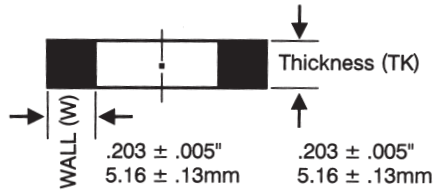

DASH NO.-425 to -465

NOMINAL
CROSS SECTION
1/4 INCH

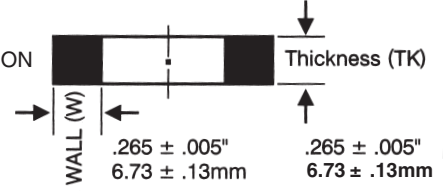

DASH NO.	NOMINAL SIZE		ACTUAL SIZE (INCH)	
	I.D.	O.D.	I.D.	TOL.±
351	4-3/4	5-1/8	4.725	.030
352	4-7/8	5-1/4	4.850	.030
353	5	5-3/8	4.975	.037
354	5-1/8	5-1/2	5.100	.037
355	5-1/4	5-5/8	5.225	.037
356	5-3/8	5-3/4	5.350	.037
357	5-1/2	5-7/8	5.475	.037
358	5-5/8	6	5.600	.037
359	5-3/4	6-1/8	5.725	.037
360	5-7/8	6-1/4	5.850	.037
361	6	6-3/8	5.975	.037
362	6-1/4	6-5/8	6.225	.040
363	6-1/2	6-7/8	6.475	.040
364	6-3/4	7-1/8	6.725	.040
365	7	7-3/8	6.975	.040
366	7-1/4	7-5/8	7.225	.045
367	7-1/2	7-7/8	7.475	.045
368	7-3/4	8-1/8	7.725	.045
369	8	8-3/8	7.975	.045
370	8-1/4	8-5/8	8.225	.050
371	8-1/2	8-7/8	8.475	.050
372	8-3/4	9-1/8	8.725	.050
373	9	9-3/8	8.975	.050
374	9-1/4	9-5/8	9.225	.055
375	9-1/2	9-7/8	9.475	.055
376	9-3/4	10-1/8	9.725	.055
377	10	10-3/8	9.975	.055
378	10-1/2	10-7/8	10.475	.060
379	11	11-3/8	10.975	.060
380	11-1/2	11-7/8	11.475	.065
381	12	12-3/8	11.975	.065
382	13	13-3/8	12.975	.065
383	14	14-3/8	13.975	.070
384	15	15-3/8	14.975	.070
385	16	16-3/8	15.955	.075
386	17	17-3/8	16.955	.075
387	18	18-3/8	17.955	.080

Gland dimensions on page 59.

DASH NO.	NOMINAL SIZE		ACTUAL SIZE (INCH)	
	I.D.	O.D.	I.D.	TOL.±
425	4-1/2	5	4.475	.033
426	4-5/8	5-1/8	4.600	.033
427	4-3/4	5-1/4	4.725	.033
428	4-7/8	5-3/8	4.850	.033
429	5	5-1/2	4.975	.037
430	5-1/8	5-5/8	5.100	.037
431	5-1/4	5-3/4	5.225	.037
432	5-3/8	5-7/8	5.350	.037
433	5-1/2	6	5.475	.037
434	5-5/8	6-1/8	5.600	.037
435	5-3/4	6-1/4	5.725	.037
436	5-7/8	6-3/8	5.850	.037
437	6	6-1/2	5.975	.037
438	6-1/4	6-3/4	6.225	.040
439	6-1/2	7	6.475	.040
440	6-3/4	7-1/4	6.725	.040
441	7	7-1/2	6.975	.040
442	7-1/4	7-3/4	7.225	.045
443	7-1/2	8	7.475	.045
444	7-3/4	8-1/4	7.725	.045
445	8	8-1/2	7.975	.045
446	8-1/2	9	8.475	.055
447	9	9-1/2	8.975	.055
448	9-1/2	10	9.475	.055
449	10	10-1/2	9.975	.055
450	10-1/2	11	10.475	.060
451	11	11-1/2	10.975	.060
452	11-1/2	12	11.475	.060
453	12	12-1/2	11.975	.060
454	12-1/2	13	12.475	.060
455	13	13-1/2	12.975	.060
456	13-1/2	14	13.475	.070
457	14	14-1/2	13.975	.070
458	14-1/2	15	14.475	.070
459	15	15-1/2	14.975	.070
460	15-1/2	16	15.475	.070
461	16	16-1/2	15.955	.075
462	16-1/2	17	16.455	.075
463	17	17-1/2	16.955	.080
464	17-1/2	18	17.455	.085
465	18	18-1/2	17.955	.085

O-Ring Groove Design Criteria and Installation Data*

Seal Applications

All seal applications may be broken down into static (the O-Ring and metal surfaces remain relatively fixed) or dynamic (the O-Ring moves relative to the mating surface).

Static Sealing

Most O-Rings are used in static service. They may be applied as face seals or radial seals. In face seal applications, the O-Ring should seat against the low pressure side of the groove.

Dynamic Sealing

A moving seal may be further classified by the type of motion: reciprocating, oscillating, or rotating. The greatest number of dynamic seals are used in reciprocating service in cylinders, valves, and linear actuators. Oscillating motion is encountered in swivels and valve stems. When an O-Ring is used on a rotating shaft, it should be limited to light duty where the shaft speed is low and some fluid bypass is acceptable.

In all dynamic applications, proper lubrication and good heat dissipation are essential to long seal life and performance. In pneumatic applications, supplemental lubrication should be provided. Lubricants should be selected on the basis of the material of which the O-Ring is made and the type of service to which it will be subjected. (See lubricant descriptions and applications information on page 86.)

Design standards have been developed for each of the standard O-Ring cross sections and diameters. These are published as SAE, MIL-Spec, and company standards. Adherence to the standard design recommendation will guarantee satisfactory seal performance in most instances. Special consideration should be given to the following areas:

Gland Shape

A basic rectangular groove is generally best. Special groove configurations are sometimes employed but are not recommended.

*Complete O-Ring groove design criteria and dimensional data compiled to include all compounds and applications can be quite voluminous. The information and data presented in this section is presented only as a basic introduction to the subject as a general guide for most compounds and applications. It is not intended to address all possible situations or contingencies. For further information or referral, contact your APG representative.

Squeeze

Initial design squeeze or compression provides for low pressure sealing. Depending on the cross section (CS), a squeeze from 10% to 35% is recommended. Higher percentage squeeze may be tolerated in static seals where friction and wear are not considerations. In dynamic service, it is often desirable to reduce O-Ring compression to a minimum. As a rule, design squeeze should not fall below 0.010 inch.

Pressure

Up to a certain point, sealing is enhanced by pressure. However, pressure may cause an increase in friction and wear. Above 1500 psi, pressure may cause extrusion and seal failure in a standard gland configuration. An anti-extrusion back-up ring, made of a tough, cut-resistant material such as leather, PTFE, or hard rubber, is suggested. In static applications, it may be possible to modify the gland design to withstand the higher pressures without the addition of a back-up ring.

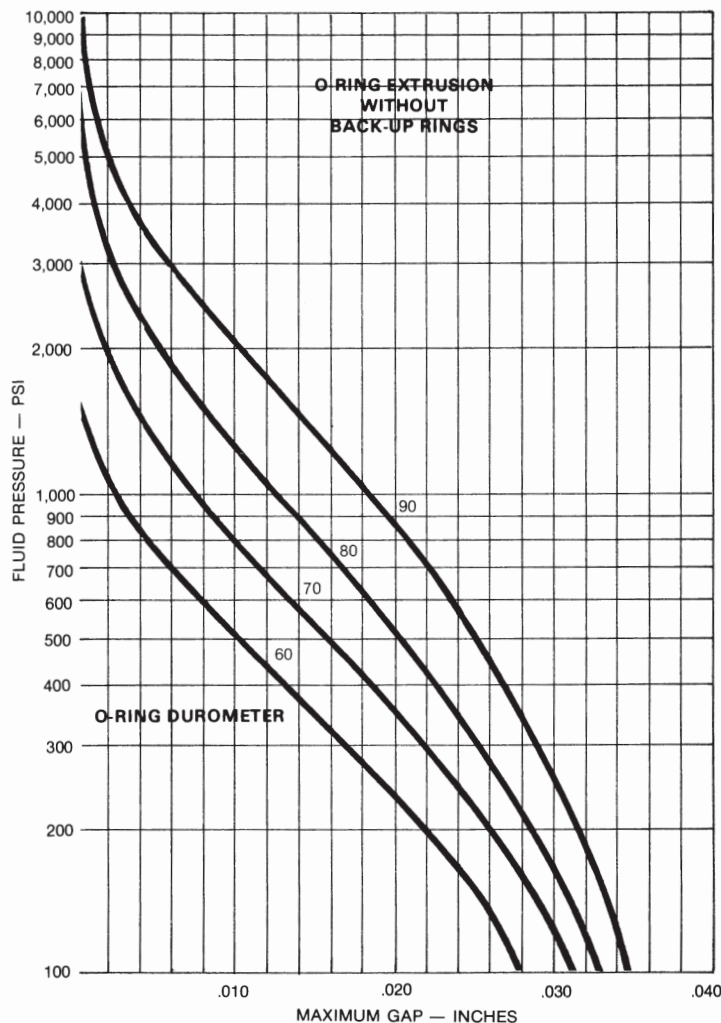

Surface Finish

The ideal surface finish for dynamic surfaces against which the O-Ring will rub is 5 to 16 μ inch RMS. Rougher and smoother surfaces may result in increased friction and reduced seal life. Rougher finishes up to 64 μ inch RMS can be tolerated in static applications.

Final Specification

End use plays a key role in O-Ring design. Dynamic seals, whether reciprocating, oscillating or rotating motion (or any combination of these) call for the highest degree of precision in O-Ring design because of the dimensional variations involved. Static applications on the other hand, permit wider tolerances, rougher surface finishes and greater applied pressure limits without danger of failure.

1. Improper mechanical design - may cause excessive pressure on O-Ring, abrasion from friction (particularly with dynamic seals), compression set.
2. Fluid attack - chemicals or oils may degrade O-Ring material; high fluid pressure may work O-Ring beyond its limits, cause extrusion flow.
3. O-Ring design - dimension or cross-section may not be properly matched to the application; material may not be sufficient to withstand fluids, pressures, dynamic friction abrasion.
4. _____
Temperatures - excessive heat (either from ambient or fluid conditions) can cause degradation; excessive

Illustration of Industrial O-Ring Application

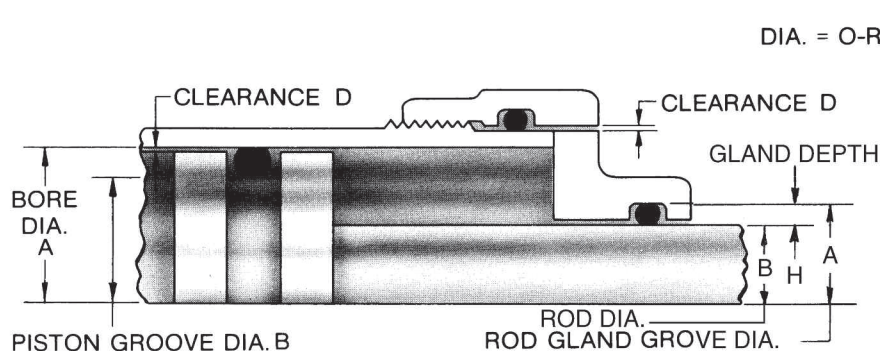

O-Ring Gland Design

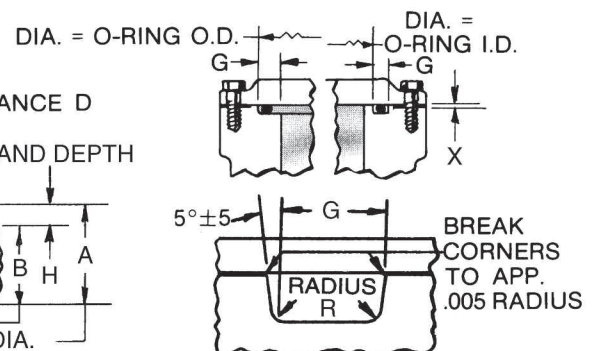

Gland Dimensional Data (Inches)

AS 568A DASH NOS.	H GLAND DEPTH	SQUEEZE		D DIAMETRAL CLEARANCE	G GROOVE WIDTH			R RADIUS
		ACTUAL	%		NO BACK-UPS	ONE BACK-UP	TWO BACK-UPS	
Reciprocating Seals								
006-012	.055 to .057	.010 to .018	15 to 25	.002 to .005	.093 to .098	.138 to .143	.205 to .210	.005 to .015
104-116	.088 to .090	.010 to .018	10 to 17	.002 to .005	.140 to .145	.171 to .176	.238 to .243	.005 to .015
201-222	.121 to .123	.012 to .022	9 to 16	.003 to .006	.187 to .192	.208 to .213	.275 to .280	.010 to .025
309-349	.185 to .188	.017 to .030	8 to 14	.003 to .006	.281 to .286	.311 to .316	.410 to .415	.020 to .035
425-460	.237 to .240	.029 to .044	11 to 16	.004 to .007	.375 to .380	.408 to .413	.538 to .543	.020 to .035
Static Seals								
004-050	.050 to .052	.015 to .023	22 to 32	.002 to .005	.093 to .098	.138 to .143	.205 to .210	.005 to .015
102-178	.081 to .083	.017 to .025	17 to 24	.002 to .005	.140 to .145	.171 to .176	.238 to .243	.005 to .015
201-284	.111 to .113	.022 to .032	16 to 23	.003 to .006	.187 to .192	.208 to .213	.275 to .280	.010 to .025
309-395	.170 to .173	.032 to .045	15 to 21	.003 to .006	.281 to .286	.311 to .316	.410 to .415	.020 to .035
425-475	.226 to .229	.040 to .055	15 to 20	.004 to .007	.375 to .380	.408 to .413	.538 to .543	.020 to .035

AS 568A DASH NOS.	X GROOVE DEPTH	SQUEEZE		G GROOVE WIDTH		R RADIUS
		ACTUAL	%	LIQUIDS	VACUUM AND GASES	
Face Seals						
004-050	.050 to .054	.013 to .023	19 to 32	.101 to .107	.084 to .089	.005 to .015
102-178	.074 to .080	.020 to .032	20 to 30	.136 to .142	.120 to .125	.005 to .015
201-284	.101 to .107	.028 to .042	20 to 30	.177 to .187	.158 to .164	.010 to .025
309-395	.152 to .162	.043 to .063	21 to 30	.270 to .290	.239 to .244	.020 to .035
425-475	.201 to .211	.058 to .080	21 to 29	.342 to .362	.309 to .314	.020 to .035

AS 568A DASH NOS.	H GLAND DEPTH	SQUEEZE %	D DIAMETRAL CLEARANCE	G GROOVE WIDTH	R RADIUS
Rotary Seals					
004-045	.065 to .067	0-11	.012 to .016	.075 to .079	.005 to .015
102-163	.097 to .099	1-8.5	.012 to .016	.108 to .112	.005 to .015
201-258	.133 to .135	0-7	.016 to .020	.144 to .148	.010 to .025

Installation Data (Inches)										
AS 568A DASH NOS.	STATIC SEALS				RECIPROCATING SEALS				ROTARY SEALS	
	ID SEALING		OD SEALING		ID SEALING		OD SEALING		ID SEALING	
	A	B	A	B	A	B	A	B	A	B
-001	.101	.040	.105	.044						
-001-1/2	.142	.081	.146	.085						
-002	.132	.053	.138	.059						
-003	.162	.067	.172	.077						
-004	.181	.081	.206	.106					.202	.072
-005	.212	.112	.237	.137					.233	.103
-006	.225	.125	.250	.150	.234	.124	.249	.139	.246	.116
-007	.256	.156	.281	.181	.265	.155	.280	.170	.277	.147
-008	.287	.187	.312	.212	.296	.186	.311	.201	.308	.178
-009	.318	.218	.343	.243	.328	.218	.343	.233	.340	.210
-010	.350	.250	.375	.275	.359	.249	.374	.264	.371	.241
-011	.412	.312	.437	.337	.421	.311	.436	.326	.433	.303
-012	.475	.375	.500	.400	.484	.374	.439	.389	.496	.366
-013	.537	.437	.562	.462					.558	.428
-014	.600	.500	.625	.525					.621	.491
-015	.662	.562	.687	.587					.683	.553
-016	.725	.625	.750	.650					.746	.616
-017	.787	.687	.812	.712					.808	.678
-018	.850	.750	.875	.775					.871	.741
-019	.912	.812	.937	.837					.933	.803
-020	.975	.875	1.000	.900					.996	.866
-021	1.037	.937	1.062	.962					1.058	.928
-022	1.100	1.000	1.125	1.025					1.121	.991
-023	1.162	1.062	1.187	1.087					1.183	1.053
-024	1.225	1.125	1.250	1.150					1.246	1.116
-025	1.287	1.187	1.312	1.212					1.308	1.178
-026	1.350	1.250	1.375	1.275					1.371	1.241
-027	1.412	1.312	1.437	1.337					1.433	1.303
-028	1.475	1.375	1.500	1.400					1.496	1.366
-029	1.600	1.500	1.625	1.525					1.621	1.491
-030	1.725	1.625	1.750	1.650					1.746	1.616
-031	1.850	1.750	1.875	1.775					1.871	1.741
-032	1.975	1.875	2.000	1.900					1.996	1.866
-033	2.100	2.000	2.125	2.025					2.121	1.991
-034	2.225	2.125	2.250	2.150					2.246	2.116
-035	2.350	2.250	2.375	2.275					2.371	2.241
-036	2.475	2.375	2.500	2.400					2.496	2.366
-037	2.600	2.500	2.625	2.525					2.621	2.491
-038	2.725	2.625	2.750	2.650					2.746	2.616
-039	2.850	2.750	2.875	2.775					2.871	2.741
-040	2.975	2.875	3.000	2.900					2.996	2.866

Recommended Tolerances (Inches)		
AS 568A DASH NOS.	A	B
-004 through -012	+ .000 - .001	+ .000 - .001
-013 through -050	+ .002 - .000	+ .000 - .002
-120 through -178		
-201 through -284		
-309 through -395	+ .003 - .000	+ .000 - .003
-425 through -475		

Questions?
Just ask. We can help!

Installation Data (Continued)										
(Inches)										
AS 568A DASH NOS.	STATIC SEALS				RECIPROCATING SEALS				ROTARY SEALS	
	ID SEALING		OD SEALING		ID SEALING		OD SEALING		ID SEALING	
	A	B	A	B	A	B	A	B	A	B
-041	3.100	3.000	3.125	3.025					3.121	2.991
-042	3.350	3.250	3.375	3.275					3.371	3.241
-043	3.600	3.500	3.625	3.525					3.621	3.491
-044	3.850	3.750	3.875	3.775					3.871	3.741
-045	4.100	4.000	4.125	4.025					4.121	3.991
-046	4.350	4.250	4.375	4.275						
-047	4.600	4.500	4.625	4.525						
-048	4.850	4.750	4.875	4.775						
-049	5.100	5.000	5.125	5.025						
-050	5.350	5.250	5.375	5.275						
-102	.224	.062	.249	.087	.237	.061	.249	.073	.245	.051
-103	.256	.094	.281	.119	.269	.093	.281	.105	.277	.083
-104	.287	.125	.312	.150	.300	.124	.312	.136	.308	.114
-105	.318	.156	.343	.181	.331	.155	.343	.167	.339	.145
-106	.349	.187	.374	.212	.362	.186	.374	.198	.370	.176
-107	.381	.219	.406	.244	.394	.218	.406	.230	.402	.208
-108	.412	.250	.437	.275	.425	.249	.437	.261	.433	.239
-109	.474	.312	.499	.337	.487	.311	.499	.323	.495	.301
-110	.537	.375	.562	.400	.550	.374	.562	.386	.558	.364
-111	.599	.437	.625	.463	.612	.436	.624	.448	.620	.426
-112	.662	.500	.687	.525	.675	.499	.687	.511	.683	.489
-113	.724	.562	.750	.588	.737	.561	.749	.573	.745	.551
-114	.787	.625	.812	.650	.800	.624	.812	.636	.808	.614
-115	.849	.687	.875	.713	.862	.686	.874	.698	.870	.676
-116	.912	.750	.937	.775	.925	.749	.937	.761	.933	.739
-117	.974	.812	1.000	.838					.995	.801
-118	1.037	.875	1.062	.900					1.058	.864
-119	1.099	.937	1.125	.963					1.120	.926
-120	1.162	1.000	1.187	1.025					1.183	.989
-121	1.224	1.062	1.250	1.088					1.245	1.051
-122	1.287	1.125	1.312	1.150					1.308	1.114
-123	1.349	1.187	1.375	1.213					1.370	1.176
-124	1.412	1.250	1.437	1.275					1.433	1.239
-125	1.474	1.312	1.500	1.338					1.495	1.301
-126	1.537	1.375	1.562	1.400					1.558	1.364
-127	1.599	1.437	1.625	1.463					1.620	1.426
-128	1.662	1.500	1.687	1.525					1.683	1.489
-129	1.724	1.562	1.750	1.588					1.745	1.551
-130	1.787	1.625	1.812	1.650					1.808	1.614
-131	1.849	1.687	1.875	1.713					1.870	1.676
-132	1.912	1.750	1.937	1.775					1.933	1.739
-133	1.974	1.812	2.000	1.838					1.995	1.801
-134	2.037	1.875	2.062	1.900					2.058	1.864
-135	2.099	1.937	2.125	1.963					2.121	1.927
-136	2.162	2.000	2.187	2.025					2.183	1.989
-137	2.224	2.062	2.250	2.088					2.246	2.052
-138	2.287	2.125	2.312	2.150					2.308	2.114
-139	2.349	2.187	2.375	2.213					2.371	2.177
-140	2.412	2.250	2.437	2.275					2.433	2.239
-141	2.474	2.312	2.500	2.338					2.496	2.302
-142	2.537	2.375	2.562	2.400					2.558	2.364
-143	2.599	2.437	2.625	2.463					2.621	2.427
-144	2.662	2.500	2.687	2.525					2.683	2.489
-145	2.724	2.562	2.750	2.588					2.746	2.552

Installation Data (Continued)										
(Inches)										
AS 568A DASH NOS.	STATIC SEALS				RECIPROCATING SEALS				ROTARY SEALS	
	ID SEALING		OD SEALING		ID SEALING		OD SEALING		ID SEALING	
	A	B	A	B	A	B	A	B	A	B
-146	2.787	2.625	2.812	2.650					2.808	2.614
-147	2.849	2.687	2.875	2.713					2.871	2.677
-148	2.912	2.750	2.937	2.775					2.933	2.739
-149	2.974	2.812	3.000	2.838					2.996	2.802
-150	2.037	2.875	3.062	2.900					3.058	2.864
-151	3.162	3.000	3.187	3.025					3.183	2.989
-152	3.412	3.250	3.437	3.275					3.433	3.239
-153	3.662	3.500	3.687	3.525					3.683	3.489
-154	3.912	3.750	3.937	3.775					3.933	3.739
-155	4.162	4.000	4.187	4.025					4.183	3.989
-156	4.412	4.250	4.437	4.275					4.433	4.239
-157	4.662	4.500	4.687	4.525					4.683	4.489
-158	4.912	4.750	4.937	4.775					4.933	4.739
-159	5.162	5.000	5.187	5.025					5.183	4.989
-160	5.412	5.250	5.437	5.275					5.433	5.239
-161	5.662	5.500	5.687	5.525					5.683	5.489
-162	5.912	5.750	5.937	5.775					5.933	5.739
-163	6.162	6.000	6.187	6.025					6.183	5.989
-164	6.412	6.250	6.437	6.275						
-165	6.662	6.500	6.687	6.525						
-166	6.912	6.750	6.937	6.775						
-167	7.162	7.000	7.187	7.025						
-168	7.412	7.250	7.437	7.275						
-169	7.662	7.500	7.687	7.525						
-170	7.912	7.750	7.937	7.775						
-171	8.162	8.000	8.187	8.025						
-172	8.412	8.250	8.437	8.275						
-173	8.662	8.500	8.687	8.525						
-174	8.912	8.750	8.937	8.775						
-175	9.162	9.000	9.187	9.025						
-176	9.412	9.250	9.437	9.275						
-177	9.662	9.500	9.687	9.525						
-178	9.912	9.750	9.937	9.775						
-201	.409	.187	.437	.215	.427	.185	.437	.195	.439	.173
-202	.472	.250	.500	.278	.500	.248	.500	.258	.502	.236
-203	.534	.312	.562	.340	.562	.310	.562	.320	.564	.298
-204	.597	.375	.625	.403	.625	.373	.625	.383	.627	.361
-205	.659	.437	.687	.465	.687	.435	.687	.445	.689	.423
-206	.722	.500	.750	.528	.750	.498	.750	.508	.752	.486
-207	.784	.562	.812	.590	.812	.560	.812	.570	.814	.548
-208	.847	.625	.875	.653	.875	.623	.875	.633	.877	.611
-209	.909	.687	.937	.715	.937	.685	.937	.695	.939	.673
-210	.972	.750	1.000	.778	.990	.748	1.000	.758	1.002	.736
-211	1.034	.812	1.062	.840	1.052	.810	1.062	.820	1.064	.798
-212	1.097	.875	1.125	.903	1.115	.873	1.125	.883	1.127	.861
-213	1.159	.937	1.187	.965	1.177	.935	1.187	.945	1.189	.923
-214	1.222	1.000	1.250	1.028	1.240	.998	1.250	1.008	1.252	.986
-215	1.284	1.062	1.312	1.090	1.302	1.060	1.312	1.070	1.314	1.048
-216	1.347	1.125	1.375	1.153	1.365	1.123	1.375	1.133	1.377	1.111
-217	1.409	1.187	1.437	1.215	1.427	1.185	1.437	1.195	1.439	1.173
-218	1.472	1.250	1.500	1.278	1.490	1.248	1.500	1.258	1.502	1.236
-219	1.534	1.312	1.562	1.340	1.552	1.310	1.562	1.320	1.564	1.298
-220	1.597	1.375	1.625	1.403	1.615	1.373	1.625	1.383	1.627	1.361

Installation Data (Continued) (Inches)

AS 568A DASH NOS.	STATIC SEALS				RECIPROCATING SEALS				ROTARY SEALS	
	ID SEALING		OD SEALING		ID SEALING		OD SEALING		ID SEALING	
	A	B	A	B	A	B	A	B	A	B
-221	1.659	1.437	1.687	1.465	1.677	1.435	1.687	1.445	1.689	1.423
-222	1.722	1.500	1.750	1.528	1.740	1.498	1.750	1.508	1.752	1.486
-223	1.847	1.625	1.875	1.653					1.877	1.611
-224	1.972	1.750	2.000	1.778					2.002	1.736
-225	2.097	1.875	2.125	1.903					2.127	1.861
-226	2.222	2.000	2.250	2.028					2.252	1.986
-227	2.347	2.125	2.375	2.153					2.377	2.111
-228	2.472	2.250	2.500	2.278					2.502	2.236
-229	2.597	2.375	2.625	2.403					2.627	2.361
-230	2.722	2.500	2.750	2.528					2.752	2.486
-231	2.847	2.625	2.875	2.653					2.877	2.611
-232	2.972	2.750	3.000	2.778					3.002	2.736
-233	3.097	2.875	3.125	2.903					3.127	2.861
-234	3.222	3.000	3.250	3.028					3.252	2.986
-235	3.347	3.125	3.375	3.153					3.377	3.111
-236	3.472	3.250	3.500	3.278					3.502	3.236
-237	3.597	3.375	3.625	3.403					3.627	3.361
-238	3.722	3.500	3.750	3.528					3.752	3.486
-239	3.847	3.625	3.875	3.653					3.877	3.611
-240	3.972	3.750	4.000	3.778					4.002	3.736
-241	4.097	3.875	4.125	3.903					4.127	3.861
-242	4.222	4.000	4.250	4.028					4.252	3.986
-243	4.347	4.125	4.375	4.153					4.377	4.111
-244	4.472	4.250	4.500	4.278					4.502	4.236
-245	4.597	4.375	4.625	4.403					4.627	4.361
-246	4.722	4.500	4.750	4.528					4.752	4.486
-247	4.847	4.625	4.875	4.653					4.877	4.611
-248	4.972	4.750	5.000	4.778					5.002	4.736
-249	5.097	4.875	5.125	4.903					5.127	4.861
-250	5.222	5.000	5.250	5.028					5.252	4.986
-251	5.347	5.125	5.375	5.153					5.377	5.111
-252	5.472	5.250	5.500	5.278					5.502	5.236
-253	5.597	5.375	5.625	5.403					5.627	5.361
-254	5.722	5.500	5.750	5.528					5.752	5.486
-255	5.847	5.625	5.875	5.653					5.877	5.611
-256	5.972	5.750	6.000	5.778					6.002	5.736
-257	6.097	5.875	6.125	5.903					6.127	5.861
-258	6.222	6.000	6.250	6.028					6.252	5.986
-259	6.472	6.250	6.500	6.278						
-260	6.722	6.500	6.750	6.528						
-261	6.972	6.750	7.000	6.778						
-262	7.222	7.000	7.250	7.028						
-263	7.472	7.250	7.500	7.278						
-264	7.722	7.500	7.750	7.528						
-265	7.972	7.750	8.000	7.778						
-266	8.222	8.000	8.250	8.028						
-267	8.472	8.250	8.500	8.278						
-268	8.722	8.500	8.750	8.528						
-269	8.972	8.750	9.000	8.778						
-270	9.222	9.000	9.250	9.028						
-271	9.472	9.250	9.500	9.278						
-272	9.722	9.500	9.750	9.528						
-273	9.972	9.750	10.000	9.778						
-274	10.222	10.000	10.250	10.028						
-275	10.722	10.500	10.750	10.528						

Installation Data (Continued)										
(Inches)										
AS 568A DASH NOS.	STATIC SEALS				RECIPROCATING SEALS				ROTARY SEALS	
	ID SEALING		OD SEALING		ID SEALING		OD SEALING		ID SEALING	
	A	B	A	B	A	B	A	B	A	B
-276	11.222	11.000	11.250	11.028						
-277	11.722	11.500	11.750	11.528						
-278	12.222	12.000	12.250	12.028						
-279	13.222	13.000	13.250	13.028						
-280	14.222	14.000	14.250	14.028						
-281	15.222	15.000	15.250	15.028						
-282	16.222	16.000	16.250	16.028						
-283	17.222	17.000	17.250	17.028						
-284	18.222	18.000	18.250	18.028						
-309	.777	.437	.812	.472	.805	.435	.812	.442		
-310	.840	.500	.875	.535	.868	.498	.875	.505		
-311	.902	.562	.937	.597	.930	.560	.937	.567		
-312	.965	.625	1.000	.660	.993	.623	1.000	.630		
-313	1.027	.687	1.062	.722	1.055	.685	1.062	.692		
-314	1.090	.750	1.125	.785	1.118	.748	1.125	.755		
-315	1.152	.812	1.187	.847	1.180	.810	1.187	.817		
-316	1.215	.875	1.250	.910	1.243	.873	1.250	.880		
-317	1.277	.937	1.312	.972	1.305	.935	1.312	.942		
-318	1.340	1.000	1.375	1.035	1.368	.998	1.375	1.005		
-319	1.402	1.062	1.437	1.097	1.430	1.060	1.437	1.067		
-320	1.465	1.125	1.500	1.160	1.493	1.123	1.500	1.130		
-321	1.527	1.187	1.562	1.222	1.555	1.185	1.562	1.192		
-322	1.590	1.250	1.625	1.285	1.618	1.248	1.625	1.255		
-323	1.652	1.312	1.687	1.347	1.680	1.310	1.687	1.317		
-324	1.715	1.375	1.750	1.410	1.743	1.373	1.750	1.380		
-325	1.840	1.500	1.875	1.535	1.868	1.498	1.875	1.505		
-326	1.965	1.625	2.000	1.660	1.993	1.623	2.000	1.630		
-327	2.090	1.750	2.125	1.785	2.118	1.748	2.125	1.755		
-328	2.215	1.875	2.250	1.910	2.243	1.873	2.250	1.880		
-329	2.340	2.000	2.375	2.035	2.368	1.998	2.375	2.005		
-330	2.465	2.125	2.500	2.160	2.493	2.123	2.500	2.130		
-331	2.590	2.250	2.625	2.285	2.618	2.248	2.625	2.255		
-332	2.715	2.375	2.750	2.410	2.743	2.373	2.750	2.380		
-333	2.840	2.500	2.875	2.535	2.868	2.498	2.875	2.505		
-334	3.965	2.625	3.000	2.660	2.993	2.623	3.000	2.630		
-335	3.090	2.750	3.125	2.785	3.118	2.748	3.125	2.755		
-336	3.215	2.875	3.250	2.910	3.243	2.873	3.250	2.880		
-337	3.340	3.000	3.375	3.035	3.368	2.998	3.375	3.005		
-338	3.465	3.125	3.500	3.160	3.493	3.123	3.500	3.130		
-339	3.590	3.250	3.625	3.285	3.618	3.248	3.625	3.255		
-340	3.715	3.375	3.750	3.410	3.743	3.373	3.750	3.380		
-341	3.840	3.500	3.875	3.535	3.868	3.498	3.875	3.505		
-342	3.965	3.625	4.000	3.660	3.993	3.623	4.000	3.630		
-343	4.090	3.750	4.125	3.785	4.118	3.748	4.125	3.755		
-344	4.215	3.875	4.250	3.910	4.243	3.873	4.250	3.880		
-345	4.340	4.000	4.375	4.035	4.368	3.998	4.375	4.005		
-346	4.465	4.125	4.500	4.160	4.493	4.123	4.500	4.130		
-347	4.590	4.250	4.625	4.285	4.618	4.248	4.625	4.255		
-348	4.715	4.375	4.750	4.410	4.743	4.373	4.750	4.380		
-349	4.840	4.500	4.875	4.535	4.868	4.498	4.875	4.505		
-350	4.965	4.625	5.000	4.660						
-351	5.090	4.750	5.125	4.785						
-352	5.215	4.875	5.250	4.910						
-353	5.340	5.000	5.375	5.035						
-354	5.465	5.125	5.500	5.160						
-355	5.590	5.250	5.625	5.285						

Installation Data (Continued)										
(Inches)										
AS 568A DASH NOS.	STATIC SEALS				RECIPROCATING SEALS				ROTARY SEALS	
	ID SEALING		OD SEALING		ID SEALING		OD SEALING		ID SEALING	
	A	B	A	B	A	B	A	B	A	B
-356	5.715	5.375	5.750	5.410						
-357	5.840	5.500	5.875	5.535						
-358	5.965	5.625	6.000	5.660						
-359	6.090	5.750	6.125	5.785						
-360	6.215	5.875	6.250	5.910						
-361	6.340	6.000	6.375	6.035						
-362	6.590	6.250	6.625	6.285						
-363	6.840	6.500	6.875	6.535						
-364	7.090	6.750	7.125	6.785						
-365	7.340	7.000	7.375	7.035						
-366	7.590	7.250	7.625	7.285						
-367	7.840	7.500	7.875	7.535						
-368	8.090	7.750	8.125	7.785						
-369	8.340	8.000	8.375	8.035						
-370	8.590	8.250	8.625	8.285						
-371	8.840	8.500	8.875	8.535						
-372	9.090	8.750	9.125	8.785						
-373	9.340	9.000	9.375	9.035						
-374	9.590	9.250	9.625	9.285						
-375	9.840	9.500	9.875	9.535						
-376	10.090	9.750	10.125	9.785						
-377	10.340	10.000	10.375	10.035						
-378	10.840	10.500	10.875	10.535						
-379	11.340	11.000	11.375	11.035						
-380	11.840	11.500	11.875	11.535						
-381	12.340	12.000	12.375	12.035						
-382	13.340	13.000	13.375	13.035						
-383	14.340	14.000	14.375	14.035						
-384	15.340	15.000	15.375	15.035						
-385	16.340	16.000	16.375	16.035						
-386	17.340	17.000	17.375	17.035						
-387	18.340	18.000	18.375	18.035						
-388	19.340	19.000	19.375	19.035						
-389	20.340	20.000	20.375	20.035						
-390	21.340	21.000	21.375	21.035						
-391	22.340	22.000	22.375	22.035						
-392	23.340	23.000	23.375	23.035						
-393	24.340	24.000	24.375	24.035						
-394	25.340	25.000	25.375	25.035						
-395	26.340	26.000	26.375	26.035						
-425	4.952	4.500	5.000	4.584	4.971	4.497	5.002	4.528		
-426	5.077	4.625	5.125	4.673	5.096	4.622	5.127	4.653		
-427	5.202	4.750	5.250	4.798	5.221	4.747	5.252	4.778		
-428	5.327	4.875	5.373	4.923	5.346	4.872	5.377	4.903		
-429	5.452	5.000	5.500	5.048	5.471	4.997	5.502	5.028		
-430	5.577	5.125	5.625	5.173	5.596	5.122	5.627	5.153		
-431	5.702	5.250	5.750	5.298	5.721	5.247	5.752	5.278		
-432	5.827	5.375	5.875	5.423	5.846	5.372	5.877	5.403		
-433	5.952	5.500	6.000	5.548	5.971	5.497	6.002	5.528		
-434	6.077	5.625	6.125	5.673	6.096	5.622	6.127	5.653		
-435	6.202	5.750	6.250	5.798	6.221	5.747	6.252	5.778		
-436	6.327	5.875	6.375	5.923	6.346	5.872	6.377	5.903		
-437	6.452	6.000	6.500	6.048	6.471	5.997	6.502	6.028		
-438	6.702	6.250	6.750	6.298	6.721	6.247	6.752	6.278		
-439	6.952	6.500	7.000	6.548	6.971	6.497	7.002	6.528		
-440	7.202	6.750	7.250	6.798	7.221	6.747	7.252	6.778		

Installation Data (Continued)										
(Inches)										
AS 568A DASH NOS.	STATIC SEALS				RECIPROCATING SEALS				ROTARY SEALS	
	ID SEALING		OD SEALING		ID SEALING		OD SEALING		ID SEALING	
	A	B	A	B	A	B	A	B	A	B
-441	7.452	7.000	7.500	7.048	7.471	6.997	7.502	7.028		
-442	7.702	7.250	7.750	7.298	7.721	7.247	7.752	7.278		
-443	7.952	7.500	8.000	7.548	7.971	7.497	8.002	7.528		
-444	8.202	7.750	8.250	7.798	8.221	7.747	8.252	7.778		
-445	8.452	8.000	8.500	8.048	8.471	7.997	8.502	8.028		
-446	8.952	8.500	9.000	8.548	8.971	8.497	9.002	8.528		
-447	9.452	9.000	9.500	9.048	9.471	8.997	9.502	9.028		
-448	9.952	9.500	10.000	9.548	9.971	9.497	10.002	9.528		
-449	10.452	10.000	10.500	10.048	10.471	9.997	10.502	10.028		
-450	10.952	10.500	11.000	10.548	10.971	10.497	11.002	10.528		
-451	11.452	11.000	11.500	11.048	11.471	10.997	11.502	11.028		
-452	11.952	11.500	12.000	11.548	11.971	11.497	12.002	11.528		
-453	12.452	12.000	12.500	12.048	12.471	11.997	12.502	12.028		
-454	12.592	12.500	13.000	12.548	12.971	12.497	13.002	12.528		
-455	13.452	13.000	13.500	13.048	13.471	12.997	13.502	13.028		
-456	13.952	13.500	14.000	13.548	13.971	13.497	14.002	13.528		
-457	14.452	14.000	14.500	14.048	14.471	13.997	14.502	14.028		
-458	14.952	14.500	15.000	14.548	14.971	14.497	15.002	14.528		
-459	15.452	15.000	15.500	15.048	15.471	14.997	15.502	15.028		
-460	15.952	15.500	16.000	15.548	15.971	15.497	16.002	15.528		
-461	16.452	16.000	16.500	16.048						
-462	16.952	16.500	17.000	16.548						
-463	17.452	17.000	17.500	17.048						
-464	17.952	17.500	18.000	17.548						
-465	18.452	18.000	18.500	18.048						
-466	18.952	18.500	19.000	18.548						
-467	19.452	19.000	19.500	19.048						
-468	19.952	19.500	20.000	19.548						
-469	20.452	20.000	20.500	20.048						
-470	21.452	21.000	21.500	21.048						
-471	22.452	22.000	22.500	22.048						
-472	23.452	23.000	23.500	23.048						
-473	24.452	24.000	24.500	24.048						
-474	25.452	25.000	25.500	25.048						
-475	26.452	26.000	26.500	26.048						

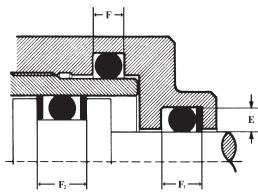

Radial Dynamic and Static
 Surface roughness:
 rod/cylinderbore
 $R_t=1-4\mu$
 base of groove,
 static $R_t=6-16\mu$
 base of groove,
 dynamic $R_t=6-10\mu$

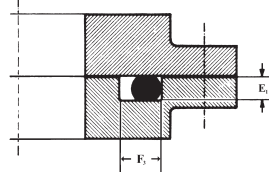

Axial Static
 Surface
 roughness:
 seal contact
 area and base
 of groove
 $R_t=6-16\mu$
 pulsating
 pressure
 $R_t=6-16\mu$

Installation Data (Millimeters)

O-Ring Cross Section	Radial Dynamic and Static				Axial Static Only		Radius	
	GROOVE DEPTH $E+0.06$ TOL.+0.06	Groove Width*			GROOVE DEPTH E_1 TOL.+0.1	GROOVE WIDTH* F_3 TOL.+0.2	R WITHOUT BACKRING	WITH BACKRING
		$F+0.2$ TOL.+0.2	$F_1+0.2$ 1 BACKRING TOL.+0.2	$F_2+0.2$ 2 BACKRING TOL.+0.2				
0.40	0.28	0.60	-	-	0.28	0.60	-	-
0.50	0.35	0.70	-	-	0.35	0.70	-	-
0.60	0.45	0.80	-	-	0.40	0.80	-	-
1.00 and 1.02	0.80	1.40	-	-	0.65	1.40	0.2	0.2
1.10, 1.12 and 1.15	0.90	1.50	-	-	0.75	1.50	0.2	0.2
1.20	0.95	1.70	-	-	0.80	1.70	0.2	0.2
1.25 and 1.27	1.00	1.80	-	-	0.85	1.80	0.2	0.2
1.30	1.05	1.80	-	-	0.90	1.80	0.2	0.2
1.42 and 1.45	1.15	1.90	-	-	0.95	1.90	0.2	0.2
1.50 and 1.52	1.20	2.10	-	-	1.00	2.10	0.2	0.2
1.57, 1.60 and 1.63	1.30	2.20	-	-	1.10	2.20	0.3	0.2
1.78 and 1.8	1.45	2.40	3.80	5.20	1.20	2.40	0.4	0.2
1.83	1.50	2.40	3.80	5.20	1.25	2.40	0.5	0.2
1.90, 1.98, 2.00 and 2.02	1.65	2.50	3.90	5.30	1.40	2.50	0.5	0.2
2.08 and 2.1	1.70	2.80	4.20	5.60	1.45	2.80	0.5	0.2
2.20 and 2.21	1.85	2.90	4.30	5.70	1.55	2.90	0.5	0.3
2.26	1.85	3.00	4.40	5.80	1.55	3.00	0.5	0.3
2.30	1.90	3.00	4.40	5.80	1.60	3.00	0.5	0.3
2.40	2.00	3.20	4.60	6.00	1.70	3.20	0.5	0.3
2.46	2.05	3.30	4.70	6.10	1.75	3.30	0.5	0.3
2.50	2.10	3.40	4.80	6.20	1.80	3.40	0.5	0.3
2.60, 2.62 and 2.70	2.25	3.60	5.00	6.40	1.90	3.60	0.6	0.3
2.70 and 2.75	2.30	3.70	5.10	6.50	1.95	3.70	0.6	0.3
2.95 and 3.00	2.50	3.90	5.30	6.70	2.20	3.90	0.8	0.3
3.15	2.70	4.00	5.40	6.80	2.30	4.00	0.8	0.4
3.50, 3.53 and 3.60	3.10	4.80	6.20	7.60	2.70	4.80	1.0	0.4
4.00	3.50	5.40	7.10	8.80	3.10	5.40	1.0	0.4
4.50	4.00	6.00	7.70	9.40	3.40	6.00	1.0	0.4
5.00	4.30	6.70	8.40	10.10	3.90	6.70	1.0	0.4
5.33	4.70	7.10	8.80	10.50	4.30	7.10	1.2	0.6
5.50	4.80	7.30	9.00	10.70	4.40	7.30	1.2	0.6
5.70 and 5.80	5.00	7.70	9.40	11.10	4.60	7.70	1.2	0.6
6.00	5.30	8.20	9.90	11.60	4.80	8.20	1.2	0.6
6.30 and 6.35	5.60	8.70	10.40	12.10	5.10	8.70	1.2	0.6
6.50	5.70	8.90	10.60	12.30	5.40	8.90	1.2	0.6
7.00	6.10	9.50	12.00	14.50	5.80	9.50	1.5	0.6
7.20	6.20	9.80	12.30	14.80	5.90	9.80	1.5	0.6
7.50	6.50	10.40	12.90	15.40	6.20	10.40	1.5	0.6
8.00	7.00	11.00	13.50	16.00	6.60	11.00	1.5	0.6
8.20	7.10	11.20	13.70	16.20	6.70	11.20	1.5	0.6
8.40	7.50	11.70	14.20	16.70	6.90	11.70	2.0	0.6
9.00	7.80	12.50	15.00	17.50	7.40	12.50	2.0	0.6
9.50	8.30	13.30	15.80	18.30	7.80	13.30	2.0	0.6
10.00	8.70	13.50	16.00	18.50	8.30	13.50	2.0	0.6
11.00	9.60	15.50	18.00	20.50	9.10	15.50	3.0	0.6
12.00	10.50	16.80	19.30	21.80	10.30	16.80	3.0	0.6
14.00	12.20	19.00	21.50	24.00	11.60	19.00	3.0	0.6
15.00	13.20	20.00	22.50	25.00	12.50	20.00	3.0	0.6
16.00	14.00	21.50	24.00	26.50	13.50	21.50	3.0	0.6

*Recommendation if the free swell of the O-Rings is less than 10% the groove width can be up to 15% smaller.

Kits

O-Ring Kits

Kits are ready to use in compact, self-contained, cases. The most popular standard and metric sizes are available in several different compounds. The charts below indicate available configurations.



STANDARD KITS				METRIC KITS				HYDRAULIC FITTING KIT*	
SIZE	NUMBER OF PIECES			EUROPEAN ASSORTMENT†		JAPANESE ASSORTMENT††		SIZE	NO. OF PIECES (620 TOTAL)
	TYPE B* (382 Total)	TYPE A** (380 Total)	CONTOURED BACK-UP RINGS*** (756 TOTAL)	SIZE	NO. OF PIECES (385 Total)	SIZE	NO. OF PIECES (396 Total)		
006	20	16	26	2.00 x 3.00	16	1.90 x 2.80	20	011	30
007	20	16	26	2.00 x 4.00	16	1.90 x 3.80	20	012	30
008	20	16	26	2.00 x 5.00	16	1.90 x 4.80	18	014	30
009	20	16	26	2.00 x 6.00	16	1.90 x 5.80	18	016	30
010	20	16	26	2.00 x 7.00	16	1.90 x 6.80	18	018	30
011	20	16	26	2.00 x 8.00	16	1.90 x 7.80	18	021	30
012	20	16	26	2.00 x 10.00	16	1.90 x 8.80	18	025	30
110	13	16	26	2.50 x 10.00	13	2.40 x 9.80	14	029	30
111	13	16	26	2.50 x 11.00	13	2.40 x 10.80	14	210	20
112	13	16	26	2.50 x 12.00	13	2.40 x 11.80	14	214	20
113	13	16	26	2.50 x 14.00	13	2.40 x 13.80	14	219	20
114	13	16	26	2.50 x 16.00	13	2.40 x 15.80	14	222	20
115	13	16	26	2.50 x 17.00	13	2.40 x 17.80	14	225	10
116	13	16	26	2.50 x 19.00	13	2.40 x 19.80	13	228	10
210	10	12	26	3.00 x 19.00	11	3.00 x 20.00	11	232	10
211	10	12	26	3.00 x 20.00	12	3.00 x 22.00	12	904	30
212	10	12	26	3.00 x 22.00	12	3.10 x 24.40	12	905	30
213	10	12	26	3.00 x 24.00	12	3.10 x 29.40	11	906	30
214	10	12	26	3.00 x 25.00	12	3.10 x 34.40	11	908	30
215	10	12	26	3.00 x 27.00	12	3.10 x 39.40	11	910	30
216	10	12	26	3.00 x 28.00	12	3.10 x 44.40	11	912	30
217	10	12	26	3.00 x 30.00	12	3.50 x 22.10	10	914	30
218	10	12	26	3.00 x 32.00	12	3.50 x 24.70	10	916	30
219	10	12	26	3.00 x 33.00	12	3.50 x 25.70	10	920	10
220	10	7	26	3.00 x 35.00	12	3.50 x 29.70	10	924	10
221	10	7	26	3.00 x 36.00	12	3.50 x 31.70	10	932	10
222	10	7	26	3.00 x 38.00	12	3.50 x 33.70	10		
325	7	5	18	4.00 x 38.00	9	3.50 x 35.70	10		
326	7	5	18	4.00 x 41.00	9	3.50 x 39.70	10		
327	7	5	18	4.00 x 44.00	9	3.50 x 47.70	10		

*Type B - H70K Nitrile 70 Durometer
H90K Nitrile 90 Durometer
V70K Fluoroelastomer (Black) 75 Durometer
VB75K Fluoroelastomer (Brown) 75 Durometer
V90K Fluoroelastomer (Black) 90 Durometer
VB90K Fluoroelastomer (Brown) 90 Durometer
S70K Silicone 70 Durometer
A80K Atlas® 80 Durometer
N70K Chloroprene 70 Durometer
E70K EPDM 70 Durometer
QH70K Nitrile Q-Rings 70 Durometer
U90K Urethane 90 Durometer
SH70K Nitrile Square Cut Rings 70 Durometer

†European Kits - M70K Metric Nitrile 70 Durometer
MV75K Metric Fluoroelastomer (Black) 75 Durometer

††Japanese Kits - M70KJ Metric Nitrile 70 Durometer
M90KJ Metric Nitrile 90 Durometer

H90KHDKIT
Nitrile
90 Durometer
VB90KHDKIT
Fluoroelastomer
90 Durometer

* Combines 3 popular Hydraulic Fitting Kits: ORS Flat Face, Boss, and Split Flange.

**Type A - TFEK PTFE

***Contoured HB90K Nitrile 90 Durometer
Back-up Rings

O-Ring Kits (continued)

SPLIT FLANGE KITS*		
SIZE	FLANGE SIZE	NO. OF PIECES (95 TOTAL)
210	8	10
212	10	10
214	12	10
219	16	15
222	20	15
225	24	15
228	32	8
232	40	6
237	48	6

H90KFLANGE Nitrile 90 Durometer
 VB90KFLANGE Fluoroelastomer (Brown) 90 Durometer

FLAT FACE KITS*		
SIZE	TUBE SIZE	NO. OF PIECES (175 TOTAL)
011	4	25
012	6	25
014	8	25
016	10	25
018	12	25
021	16	25
025	20	15
029	24	10

H90KFACE Nitrile 90 Durometer
 VB90KFACE Fluoroelastomer (Brown) 90 Durometer

MALE STRAIGHT THREAD ELBOW KIT*		
SIZE	TUBE SIZE	NO. OF PIECES (35 TOTAL)
1.60 X 8.10	10	20
2.40 X 9.30	12	20
2.00 X 11.50	14	20
2.40 X 15.60	18	10
909	20	10
2.40 X 19.80	22	10
912	27	10
916	33	10
3.00 X 39.20	42	5

H90MSTRAIGHT Nitrile 90 Durometer

* For Split Flange Type Hydraulic Hose Fittings.

* For ORS Hydraulic Hose Fittings.

* For Male 37 JIC to Male Metric Straight Thread Elbow Fittings.

STAPLOK KIT		
SIZE	DASH SIZE	NO. OF PIECES (105 TOTAL)
2.00 X 6.00	04	20
2.00 X 10.00	06	20
2.50 X 13.00	08	20
2.50 X 19.00	12	10
2.50 X 25.00	16	10
2.50 X 33.00	20	10
3.00 X 40.00	24	10
3.00 X 50.00	32	5

H90STAPLOK Nitrile 90 Durometer

BSP FITTING KIT		
SIZE	TUBE SIZE	NO. OF PIECES (105 TOTAL)
010	2	20
111	4	20
113	6	20
2.62 X 17.86	8	10
2.26 X 20.63	10	10
119	12	10
217	16	10
222	20	5

H90MBSP Nitrile 90 Durometer

BOSS KITS			
20 SIZES		12 SIZES	
SIZE	NO. OF PIECES (212 TOTAL)	SIZE	NO. OF PIECES (240 TOTAL)
901	10	901	-
902	10	902	25
903	10	903	25
904	10	904	25
905	12	905	25
906	12	906	25
907	12	907	-
908	12	908	20
909	12	909	-
910	12	910	20
911	10	911	-
912	10	912	15
913	10	913	-
914	10	914	15
916	10	916	15
918	10	918	-
920	10	920	15
924	10	924	15
928	10	928	-
932	10	932	-

H90KB0SS Nitrile 90 Durometer

H90KB0SS12 Nitrile 90 Durometer

VB90KB0SS Fluoroelastomer (Brown) 90 Durometer

VB90KB0SS12 Fluoroelastomer (Brown) 90 Durometer

O-Ring Kits (continued)

TRUCK REFRIGERATION KIT			R134A AUTO A/C KIT*			PLUMBING KIT	
SIZE	NO. OF PIECES (300 TOTAL)	MATERIAL	SIZE	NO. OF PIECES (480 TOTAL)	STYLE (COLOR)	SIZE	NUMBER OF PIECES (200 TOTAL)
011	50	CHLOROPRENE	008	50	GREEN	010	35
011	50	HNBR (Green)	011	50	BLUE	011	35
013	50	CHLOROPRENE	011	50	GREEN	012	25
013	50	HNBR (Green)	013	50	BLUE	110	25
015	25	CHLOROPRENE	013	50	GREEN	111	15
015	25	HNBR (Green)	015	25	BLUE	112	10
017	25	CHLOROPRENE	015	25	GREEN	113	10
017	25	HNBR (Green)	017	25	BLUE	114	10
			017	25	GREEN	115	10
			108	50	BLUE	116	10
			110	50	BLUE	211	8
			112	30	BLUE	212	7

HS/N70K Chloroprene 70 Durometer/
Green HNBR 70 Durometer

HS/HST70K HNBR (HSN)
Green & Blue TFE Coated

H70PK
Nitrile 70 Durometer

* Required for Refrigerant R134A. Can also be used for R12.

THREAD SEAL KIT	
7500 Series 70 Durometer Nitrile and Commercial CAD Plated Steel	
SIZE	NUMBER OF PIECES (200 TOTAL)
- 10	10
- 1/4	10
- 5/16	10
- 3/8	10
- 1/2	10
- 5/8	10
- 3/4	10

ATS7500-KIT
Nitrile 70 Durometer
with Commercial
CAD Plated Steel

U-CUP KIT			
(156 TOTAL PIECES)			
626 SERIES PART NUMBER / SIZE	NUMBER OF PIECES (96 TOTAL)	8400 SERIES PART NUMBER / SIZE	NUMBER OF PIECES (60 TOTAL)
NU6226-8	10	NU8404-0056	10
NU6226-14	10	NU8404-0062	10
NU6226-16	6	NU8404-0075	10
NU6226-18	6	NU8404-0087	10
NU6226-20	4	NU8404-0100	10
NU6226-22	4	NU8404-0118	10
NU6226-43	10		
NU6226-44	10		
NU6226-45	10		
NU6226-47	10		
NU6226-49	10		
NU6226-51	6		

NU6226-84-KIT
Nitrile 70 and 80 Durometer

O-Ring Kits (continued)



WAREHOUSE KITS*							
STANDARD KITS				METRIC KITS			
SIZE	NO. OF PIECES (1326 Total)	SIZE	NO. OF PIECES	SIZE	NO. OF PIECES (1465 Total)	SIZE	NO. OF PIECES
006	50	211	15	1.50 X 5.00	50	2.50 X 25.00	10
007	50	212	15	1.50 X 6.00	50	3.00 X 9.00	10
008	50	213	15	1.50 X 7.00	50	3.00 X 12.00	10
009	50	214	15	1.50 X 8.00	50	3.00 X 14.00	10
010	50	215	15	1.50 X 9.00	50	3.00 X 15.00	10
011	50	216	10	1.50 X 10.00	50	3.00 X 16.00	10
012	50	217	10	1.50 X 12.00	50	3.00 X 18.00	10
013	50	218	10	1.50 X 14.00	50	3.00 X 19.00	10
014	50	219	10	2.00 X 4.00	50	3.00 X 20.00	10
015	30	220	10	2.00 X 5.00	50	3.00 X 22.00	10
016	30	221	10	2.00 X 6.00	50	3.00 X 24.00	10
017	30	222	10	2.00 X 7.00	50	3.00 X 25.00	10
018	30	223	10	2.00 X 8.00	50	3.00 X 27.00	10
019	30	224	10	2.00 X 9.00	50	3.00 X 28.00	10
020	30	320	6	2.00 X 10.00	50	3.00 X 30.00	10
021	25	321	6	2.00 X 11.00	50	3.00 X 32.00	10
022	25	322	6	2.00 X 12.00	50	3.00 X 33.00	10
023	25	323	6	2.00 X 13.00	25	3.00 X 34.00	10
024	25	324	6	2.00 X 14.00	25	3.00 X 35.00	10
025	25	325	6	2.00 X 15.00	25	3.00 X 36.00	10
110	30	326	6	2.00 X 16.00	25	3.00 X 38.00	10
111	30	327	6	2.00 X 17.00	25	3.00 X 44.00	10
112	30	328	6	2.00 X 18.00	25	3.00 X 45.00	10
113	30	329	6	2.00 X 20.00	10	3.00 X 54.00	10
114	30	330	6	2.00 X 22.00	10	4.00 X 38.00	10
115	30	425	3	2.00 X 30.00	10	4.00 X 41.00	10
116	15	426	3	2.00 X 40.00	10	4.00 X 44.00	10
117	15	427	3	2.50 X 10.00	25	O-RING CORD	
118	15	428	3	2.50 X 11.00	25	DIAMETER	LENGTH
119	15	O-RING CORD		2.50 X 12.00	25	1.50 mm ¹	1 meter
120	15	DIAMETER	LENGTH	2.50 X 13.00	10	2.00 mm	1 meter
121	15	0.070"	7'	2.50 X 14.00	10	2.50 mm	1 meter
122	15	0.103"	7'	2.50 X 15.00	10	3.00 mm	1 meter
123	15	0.139"	7'	2.50 X 16.00	10	3.50 mm	1 meter
124	15	0.210"	7'	2.50 X 17.00	10	4.00 mm	1 meter
210	15	0.275"	7'	2.50 X 18.00	10	5.00 mm	1 meter
				2.50 X 19.00	10	5.70 mm	1 meter
				2.50 X 22.00	10	8.40 mm ²	1 meter

H70KW

Nitrile

70 Durometer

M70KW

Metric Nitrile

70 Durometer

V70KW

Fluoroelastomer

75 Durometer

MV70KW

Metric Fluoroelastomer

75 Durometer

¹ 1.60 in MV70KW

² 8.00 in MV70KW

* Each kit is contained in a 38-drawer storage box with the o-rings and cord stock as listed above, plus two o-ring picks, razor blade, cutting and splicing jig, and rapidset adhesive.

O-Ring Kits (continued)

CONTOURED BACKUP RING KITS		Q-RING KITS	
SIZE	NO. OF PIECES (295 TOTAL)	SIZE	NO. OF PIECES (295 TOTAL)
005	10	005	10
006	10	006	10
007	10	007	10
008	10	008	10
009	10	009	10
010	10	010	10
011	10	011	10
012	10	012	10
013	10	013	6
014	10	014	6
015	10	015	6
016	10	016	6
017	10	017	5
018	10	018	5
110	12	110	6
112	12	112	6
113	9	113	6
114	9	114	6
115	9	115	6
116	9	116	6
117	5	117	4
118	5	118	4
119	5	119	4
120	5	120	4
121	5	121	4
210	7	210	5
211	7	211	5
212	7	212	5
213	7	213	5
214	5	214	5
215	5	215	5
216	5	216	5
217	5	217	5
218	5	218	5
219	5	219	5

HB90K Nitrile 90 Durometer

QH70K Nitrile Q-Rings 70 Durometer

STANDARD NITRILE/FLUOROELASTOMER COMBO WAREHOUSE KIT		
SIZE	1168 TOTAL PIECES	
	NITRILE NO. OF PIECES (584 TOTAL)	FLUOROELASTOMER NO. OF PIECES (584 TOTAL)
006	65	65
007	65	65
009	65	65
010	65	65
011	65	65
012	65	65
013	12	12
014	12	12
015	12	12
016	12	12
210	9	9
211	9	9
212	9	9
213	9	9
214	9	9

H70/V70 COMBO
Nitrile 70 Durometer
Fluoroelastomer 75 Durometer (Black)

H70/VB75COMBO
Nitrile 70 Durometer
Fluoroelastomer 75 Durometer (Brown)

O-Ring Splicing Kits

Contains everything necessary for making on-the-job custom O-Rings. Eliminates waiting and down time. Each kit includes razor blade, cutting and splicing jig, rapid-set adhesive, and cord stock as listed in the chart.



SPLICING KIT CORD CONTENTS

PART NUMBER	COMPOUND	CORD DIAMETER	LENGTH
ORSKB ORSKV	Buna-N(Inches) Viton®	.103"	7 ft.
		.139"	7 ft.
		.210"	7 ft.
		.275"	7 ft.
ORSKMB	Buna-N(Metric)	1.50mm	1 meter
		2.00mm	1 meter
		2.50mm	1 meter
		3.00mm	1 meter
		3.50mm	1 meter
		4.00mm	1 meter
		5.00mm	1 meter
		5.70mm	1 meter
		8.40mm	1 meter

Vulcanizing

As described in the preceding pages of this catalog, APG has one of the largest inventories of O-Rings in North America. This inventory consists of “standard” sizes manufactured to the dimensions outlined throughout this catalog. There is, however, a very large and growing demand for “non-standard” O-Ring sizes that must be custom fabricated. APG meets this demand with the extensive capabilities of our vulcanizing department.

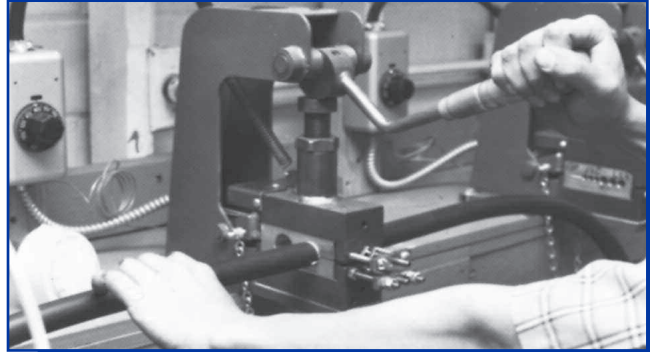

These non-standard O-Ring sizes are fabricated to the exact specifications of our customers from the cord stock described in the following pages. APG maintains large inventories of these stock materials so that O-Rings can be fabricated quickly and shipped instantly. We also vulcanize extrusions which are described after the cord stock items. Non-stock materials and sizes are also available by special order.

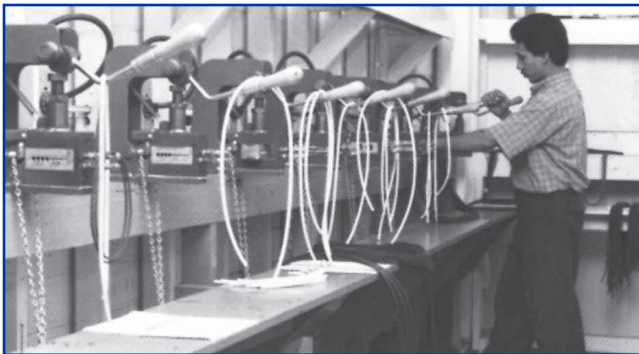

In addition, we vulcanize gaskets which are too large to be cut in one piece. These are cut in sections and vulcanized to accommodate virtually any requirement. Rubber sleeves and other custom products are also routinely vulcanized by the experienced personnel in this highly capable department at APG.

**Non-Standard Requirements?
Our Vulcanizing Department can help!**

Standards for Spliced Extrusions

Testing Procedure

The manufacture of extrusions in circular or rectangular shaped gaskets, or a combination of both can be accomplished by means of butt or beveled vulcanized splices. The splice is usually never as strong as the original material from which the gasket is made. The stronger the splice is required to be, the more difficult the labor operations. A pressure mark will appear at the splice area due to the required holding pressure in the mold.

The method of testing splices should be given serious consideration. Doubling over, pinching, twisting, or bending back a splice are not proper methods of testing. Splice strength varies with the configuration of the cross section of the extrusion. For this reason, splice strength is very difficult to define.

Pulling perpendicular to the plane of the splice is a sufficient test in the testing of a splice. The gasket should be clamped in such a way that the pull is evenly distributed over the splice.

Tolerances must be allowed in the length between splices. These tolerances must be varied according to length between splices and due to the method of making the splice. Tolerances for commercial class splices are listed in the following table. These tolerances are applicable for both conventional splices and injection splices.

Spliced Length Tolerances RMA Drawing Designation Class 2 (Commercial)			
INCHES		MILLIMETERS	
CUT LENGTH	TOLERANCE	CUT LENGTH	TOLERANCE
>0 - ≤ 10	± .250	>0 - ≤ 250	± 6.30
>10 - ≤ 15	± .280	>250 - ≤ 400	± 7.10
>15 - ≤ 25	± .315	>400 - ≤ 630	± 8.00
>25 - ≤ 40	± .355	>630 - ≤ 1000	± 9.00
>40 - ≤ 63	± .400	>1000 - ≤ 1600	± 10.00
>63 - ≤ 100	± .450	>1600 - ≤ 2500	± 11.20

Design of Extruded Endless Splices

When designing endless splices for extruded profiles, several factors must be considered: compound durometer, cut length, size of cross section, and (in the case of tubing) wall thickness.

Mold cavities are normally designed to the nominal dimension. If the extrusion cross section is at its upper tolerance limit, mold pressure marks will be visible on the surface. This phenomenon is accentuated with the use of lower durometer compounds. If the extrusion cross section is at its lower tolerance limit, the mold

cavity would have to be shimmed in order to attain the splicing pressure necessary to create surface marking. The potential for size differences at each end of a cut length increases with the length of the cut. (One end may be at the upper tolerance limit, and the other end may be at the lower tolerance limit.) Generally, this gives the appearance of a step or mismatch. The illustration below illustrates the phenomena of mold pressure marks and apparent mismatches.

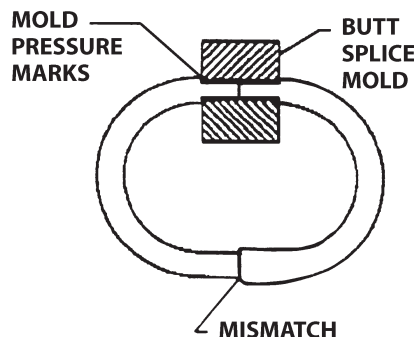

O-Ring Cord Stock and Extrusions



Style 0281

Aflas® O-Ring Cord
75 Durometer

CROSS SECTION		PART NUMBER
NOMINAL (IN.)	ACTUAL (IN.)	
3/32"	.103 – .006/+ .012	0281103
1/8"	.139 – .006/+ .014	0281139
3/16"	.210 – .006/+ .014	0281210
1/4"	.250 – .010/+ .022	0281250
	.275 – .010/+ .022	0281275
5/16"	.312 – .010/+ .022	0281312
3/8"	.375 – .010/+ .022	0281375

Style 0283

Fluoroelastomer O-Ring
Cord 75 Durometer

CROSS SECTION		PART NUMBER
NOMINAL (IN.)	ACTUAL (IN.)	
1/16"	.070 ± .010	0283070
3/32"	.093 ± .010	0283093
	.103 ± .013	0283103
1/8"	.125 ± .013	0283125
	.139 ± .016	0283139
3/16"	.187 ± .016	0283187
	.210 ± .016	0283210
1/4"	.250 ± .016	0283250
	.275 ± .020	0283275
5/16"	.312 ± .020	0283312
3/8"	.375 ± .020	0283375
7/16"	.437 ± .025	0283437
1/2"	.500 ± .025	0283500
5/8"	.625 ± .027	0283625
3/4"	.750 ± .032	0283750
1"	1.000 ± .032	02831

Style 0282

EPDM (EPR) O-Ring Cord
70 Durometer

CROSS SECTION		PART NUMBER
NOMINAL (IN.)	ACTUAL (IN.)	
1/16"	.070 ± .008	0282070
3/32"	.093 ± .008	0282093
	.103 ± .010	0282103
1/8"	.125 ± .010	0282125
	.139 ± .010	0282139
3/16"	.187 ± .014	0282187
	.210 ± .014	0282210
1/4"	.250 ± .016	0282250
	.275 ± .016	0282275
5/16"	.312 ± .016	0282312
3/8"	.375 ± .016	0282375
7/16"	.437 ± .020	0282437
1/2"	.500 ± .020	0282500
5/8"	.625 ± .027	0282625
3/4"	.750 ± .027	0282750
1"	1.000 ± .031	02821

Style 0283H

Fluoroelastomer O-Ring Cord
90 Durometer

CROSS SECTION		PART NUMBER
NOMINAL (IN.)	ACTUAL (IN.)	
1/16"	.070 ± .008	0283H070
3/32"	.103 ± .010	0283H103
	.125 ± .013	0283H125
1/8"	.139 ± .016	0283H139
	.187 ± .016	0283H187
3/16"	.210 ± .016	0283H210
	.250 ± .016	0283H250
1/4"	.275 ± .020	0283H275
	.312 ± .020	0283H312
3/8"	.375 ± .020	0283H375

Style 0283VB

Brown Fluoroelastomer
O-Ring Cord
75 Durometer

CROSS SECTION		PART NUMBER
NOMINAL (IN.)	ACTUAL (IN.)	
3/32"	.103 ± .010	0283VB103
1/8"	.125 ± .013	0283VB125
	.139 ± .016	0283VB139
3/16"	.187 ± .016	0283VB187
	.210 ± .016	0283VB210
1/4"	.250 ± .016	0283VB250
	.275 ± .020	0283VB275
5/16"	.312 ± .020	0283VB312
3/8"	.375 ± .020	0283VB375
7/16"	.437 ± .025	0283VB437
1/2"	.500 ± .025	0283VB500

Style 0284H

Buna-N O-Ring Cord
90 Durometer

CROSS SECTION		PART NUMBER
NOMINAL (IN.)	ACTUAL (IN.)	
3/32"	.103 ± .010	0284H103
1/8"	.125 ± .010	0284H125
	.139 ± .010	0284H 139
3/16"	.187 ± .014	0284H187
	.210 ± .014	0284H210
1/4"	.250 ± .014	0284H250
	.275 ± .016	0284H275
5/16"	.312 ± .016	0284H312
3/8"	.375 ± .016	0284H375
7/16"	.437 ± .020	0284H437
1/2"	.500 ± .020	0284H500

Style 0284

Buna-N O-Ring Cord
70 Durometer

CROSS SECTION		PART NUMBER
NOMINAL (IN.)	ACTUAL (IN.)	
1/16"	.062 ± .008	0284062
	.070 ± .008	0284070
3/32"	.093 ± .008	0284093
	.103 ± .010	0284103
1/8"	.125 ± .010	0284125
	.139 ± .010	0284139
3/16"	.187 ± .014	0284187
	.210 ± .014	0284210
1/4"	.250 ± .014	0284250
	.275 ± .016	0284275
5/16"	.312 ± .016	0284312
3/8"	.375 ± .016	0284375
7/16"	.437 ± .020	0284437
1/2"	.500 ± .020	0284500
9/16"	.562 ± .020	0284562
5/8"	.625 ± .020	0284625
3/4"	.750 ± .027	0284750
13/16"	.812 ± .027	0284812
7/8"	.875 ± .027	0284875
1"	1.000 ± .031	02841
1 1/4"	1.250 ± .046	02841250
1 1/2"	1.500 ± .051	02841500

Style 0284S

Buna-N O-Ring Cord
50 Durometer

CROSS SECTION		PART NUMBER
NOMINAL (IN.)	ACTUAL (IN.)	
1/8"	.139 ± .010	0284S139
3/16"	.210 ± .014	0284S210
1/4"	.250 ± .014	0284S250
1/4"	.275 ± .016	0284S275
5/16"	.312 ± .016	0284S312
3/8"	.375 ± .016	0284S375
1/2"	.500 ± .020	0284S500
5/8"	.625 ± .020	0284S625

Style 0285

Neoprene O-Ring Cord
70 Durometer

CROSS SECTION		PART NUMBER
NOMINAL (IN.)	ACTUAL (IN.)	
1/16"	.070 ± .008	0285070
3/32"	.093 ± .008	0285093
	.103 ± .010	0285103
1/8"	.125 ± .010	0285125
	.139 ± .010	0285139
3/16"	.187 ± .014	0285187
	.210 ± .014	0285210
1/4"	.250 ± .014	0285250
	.275 ± .016	0285275
5/16"	.312 ± .016	0285312
3/8"	.375 ± .016	0285375
7/16"	.437 ± .020	0285437
1/2"	.500 ± .020	0285500
9/16"	.562 ± .020	0285562
5/8"	.625 ± .020	0285625
3/4"	.750 ± .027	0285750
1"	1.000 ± .031	02851

Style 0286

Silicone O-Ring Cord
70 Durometer

CROSS SECTION		PART NUMBER
NOMINAL (IN.)	ACTUAL (IN.)	
1/16"	.070 ± .008	0286070
3/32"	.093 ± .008	0286093
	.103 ± .010	0286103
1/8"	.125 ± .010	0286125
	.139 ± .010	0286139
3/16"	.187 ± .014	0286187
	.210 ± .014	0286210
1/4"	.250 ± .014	0286250
	.275 ± .016	0286275
5/16"	.312 ± .016	0286312
3/8"	.375 ± .016	0286375
7/16"	.437 ± .020	0286437
1/2"	.500 ± .020	0286500
5/8"	.625 ± .020	0286625
3/4"	.750 ± .027	0286750
7/8"	.875 ± .039	0286875
1"	1.000 ± .051	02861

Style 0286T

70 Durometer
Silicone Tubing

SIZE (INCHES)	PART NUMBER
1/16" I.D. x 3/16" O.D.	0286T.062 ID x .187 OD
1/8" I.D. x 1/4" O.D.	0286T.125 ID x .250 OD

Style 0287

Closed Cell Neoprene
Sponge Cord

DIAMETER (IN.)	PART NUMBER
1/8"	0287125
3/16"	0287187
1/4"	0287250
5/16"	0287312
3/8"	0287375
1/2"	0287500
5/8"	0287625
3/4"	0287750
1"	02871

Style 0292

60 Durometer EPR
Extrusion

DIAMETER (IN.)	PART NUMBER
1/2" x 1/2"	0292500
5/8" x 5/8"	0292625
1/2" x 3/4"	029500 x 750

Style 0293

70 Durometer
Fluorelastomer Extrusion

DIAMETER (IN.)	PART NUMBER
5/8" x 7/8"	0293625x875

Style 0294

60 Durometer
Silicone Extrusion

Style 0295W

60 Durometer White
Neoprene Extrusion

DIAMETER (IN.)	PART NUMBER
1/2" x 1/2"	0295W500

Style 0296

Buna-N O-Ring Cord
70 Durometer (Square)

CROSS SECTION		PART NUMBER
NOMINAL (IN.)	ACTUAL (IN.)	
3/32"	.098 ± .007	0296098
1/8"	.133 ± .007	0296133
3/16"	.202 ± .010	0296202
1/4"	.264 ± .016	0296264
5/16"	.313 ± .020	0296313
3/8"	.375 ± .020	0296375
1/2"	.500 ± .025	0296500
5/8"	.625 ± .025	0296625
3/4"	.750 ± .025	0296750
1"	1.000 ± .025	0296100

Style 0297

Fluoroelastomer
Square/Rectangular
Cord 75 Durometer

CROSS SECTION		PART NUMBER
NOMINAL (IN.)	ACTUAL (IN.)	
1/8"	.125 ± .007	0297125
	.134 ± .007	0297134
3/16"	.187 ± .009	0297187
1/4"	.250 ± .010	0297250
5/16"	.313 ± .012	0297313
3/8"	.375 ± .012	0297375
3/8" x 1/2"	.375 x .500 ± .018	0297375X500
1/2"	.500 ± .018	0297500
5/8"	.625 ± .022	0297625
3/4"	.750 ± .025	0297750

Style 0M283V

Fluoroelastomer O-Ring Cord
75 Durometer (Metric)

CROSS SECTION		PART NUMBER
MILLIMETERS	INCHES	
1.6	.062 ± .008	0M283V1.6
2	.079 ± .008	0M283V2
2.4	.094 ± .008	0M283V2.4
2.5	.098 ± .008	0M283V2.5
3	.119 ± .010	0M283V3
3.5	SEE PART NUMBER 0283139	
4	.157 ± .010	0M283V4
4.5	.177 ± .014	0M283V4.5
5	.196 ± .014	0M283V5
5.7	.224 ± .014	0M283V5.7
6	.236 ± .014	0M283V6
7.5	.295 ± .016	0M283V7.5
8	.315 ± .016	0M283V8
9	.354 ± .016	0M283V9
10	.393 ± .014	0M283V10
12	.472 ± .020	0M283V12
14	.551 ± .020	0M283V14

Style 0Q283

Fluoroelastomer
Q-Ring Cord 75
Durometer

CROSS SECTION		PART NUMBER
NOMINAL (IN.)	ACTUAL (IN.)	
1/16"	.070 ± .007	0Q283070
3/32"	.103 ± .007	0Q283103
1/8"	.139 ± .010	0Q283139
3/16"	.210 ± .012	0Q283210
1/4"	.275 ± .012	0Q283275
3/8"	.375 ± .014	0Q283375
1/2"	.500 ± .018	0Q283500

Style 0M284B

Buna-N O-Ring Cord
70 Durometer (Metric)

CROSS SECTION		PART NUMBER
MILLIMETERS	INCHES	
1	.040 ± .006	0M284B1
1.6	SEE PART NUMBER 0284062	
2	.079 ± .008	0M284B2
2.4	.094 ± .008	0M284B2.4
2.5	.098 ± .008	0M284B2.5
3	.118 ± .010	0M284B3
3.5	SEE PART NUMBER 0284139	
4	.157 ± .010	0M284B4
4.5	.177 ± .014	0M284B4.5
5	.196 ± .014	0M284B5
5.7	.224 ± .014	0M284B5.7
6	.236 ± .014	0M284B6
7	SEE PART NUMBER 0284275	
7.5	.295 ± .016	0M284B7.5
8	.315 ± .016	0M284B8
8.4	.331 ± .016	0M284B8.4
9	.354 ± .016	0M284B9
10	.394 ± .020	0M284B10
11	SEE PART NUMBER 0284437	
12	.472 ± .020	0M284B12
13	.512 ± .020	0M284B13
14	.551 ± .020	0M284B14

Style 0Q284

Buna-N Q-Ring Cord
70 Durometer

CROSS SECTION		PART NUMBER
NOMINAL (IN.)	ACTUAL (IN.)	
1/8"	.139 ± .010	0Q284139
3/16"	.210 ± .010	0Q284210
1/4"	.275 ± .010	0Q284275
1/2"	.500 ± .010	0Q284500

Related O-Ring Items

Style ORC

O-Ring Measuring Cone and Tape

Unique device for measuring o-rings up to 8" inside diameter. The base of the cone is used to determine the cross section of the o-ring. Then, for o-rings 1/4" to 3" inside diameter, the ring is simply dropped over the cone, and the size is read above the o-ring. For o-rings from 3" to 8" inside diameter, the tape is simply expanded inside the o-ring, and the size is read directly from the tape. All size numbers correspond to industry ARP standard size series.

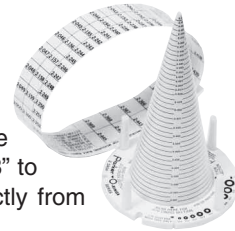

Style ORCB

Large O-Ring Measuring Cone

Similar to Style ORC, but will measure o-rings up to 5 5/8" inside diameter on the cone. No tape is included.



Style ORCH

O-Ring Sizing Chart

Laminated flip-chart pictures actual o-ring sizes up to 8" inside diameter. The o-ring is simply placed on the chart and lined up with the correct inside diameter and cross section. The standard size is then read directly from the chart.

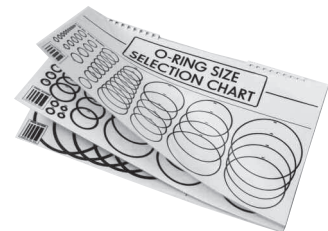

Style ORMMT

Measuring Tape for Metric O-Rings

Measures metric o-rings on one side and standard o-rings on the other. Measures metric o-rings from 70 mm to 254 mm inside diameter and standard o-rings from 3 1/8" to 10" inside diameter.



Style ORMMTL

Measuring Tape for Metric O-Rings (Large)

Same as Style ORMMT, but measures metric o-rings from 65mm to 484mm inside diameter and standard o-rings from 2-1/2" to 19" inside diameter.

Style ORSG

O-Ring Slide Gauge

Slide gauge for measuring standard O-Rings up to 13" inside diameter.



Style ORID

O-Ring Identifier

Used to verify the material composition of 60-80 durometer O-Rings that are known to be either Viton®, Kalrez®, Nitrile, or EPDM. Stainless steel tubular construction.

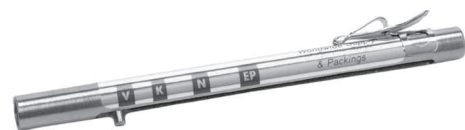

Style ORP

O-Ring Picks

Set of two brass picks with two working ends on each pick. Plastic storage pouch is included. Used to extract o-rings that have been installed. Particularly useful when o-rings have been in service or when close tolerances are involved.



Style ORL2

O-Ring Lubricant

Barium base petroleum grease formulated to facilitate installation and extend service life of synthetic rubber seals. A film applied to the seal itself as well as surfaces over which the seal will travel is suggested for best results. Combines excellent surface adherence characteristics and lubricity with inherent water resistance. It is especially recommended for low pressure pneumatic systems as well as reciprocating and low speed oscillating or rotary applications. Well suited for most sealing service within a -20° to +300°F temperature range. However, it is not recommended for use in systems having micron filters or in contact with seals unsuited for petroleum oil service such as silicone, butyl, or ethylene propylene rubber. If the conditions exist, use of Style ORLS (see below) should be considered. (2 ounce tube)

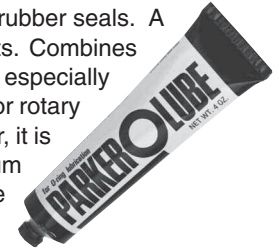

Style ORLS

O-Ring Lubricant (Super)

Silicone lubricant intended to complement Style ORL (above) in that it can be used with virtually any rubber polymer. It can also be used over a wider temperature range and in most cases will provide better environmental protection to the elastomer. It is recommended that this lubricant be used sparingly as only a thin film is necessary for best results. It is useful with a wide variety of fluid media since it is quite inert. High pressure systems as well as vacuum uses are typical applications where this lubricant is beneficial. It is useful from -65° to +400°F. It is non-toxic and non irritating under normal conditions. It will not clog 30 micron filters and is unusually moisture resistant and adheres with unusual tenacity. (2 ounce tube)



	STYLE ORL	STYLE ORLS
Type	Barium grease	High viscosity silicone fluid
Temperature Range °F °(C)	-20 to + 180 (1) (-29 to +82)	-65 to +400(2) (-54 to +204)
Seal Use	Hydrocarbon fluids Pneumatic systems under 200 psi	General purpose High pressure pneumatic
Suitable For Use With Rubber Compounds:	Fluorocarbon Fluorosilicone Neoprene Nitrile Polyphosphazine Polyacrylate Polysulfide Polyurethane	Fluorocarbon Fluorosilicone Neoprene Nitrile Polyphosphazine Polyacrylate Polysulfide Polyurethane Butadiene Butyl Ethylene Propylene Isoprene SBR (GRS) Silicone(2)
Will Pass Through Micronic Filters?	No	Yes

NOTES:

Assembly lubricants should always be used sparingly during application. A light film is all that is required. This is doubly important in cases 1 and 2 below.

1. When a thin film of Style ORL is used for assembly purposes only, the assembly may be subjected to higher temperatures, with limits determined by the fluid and elastomer being used.
2. Use only a thin film of Style ORLS on silicone rubber if the temperature will exceed 300°F.

Compound Selection for Fluids and Chemicals

	NITRILE	CHLORO-PRENE	ETHYLENE PROPYLENE (EPR)	FLUORO-ELASTOMER	SILICONE	STYRENE BUTADIENE (SBR)	FLUORO-SILICONE	BUTYL	AFLAS®	URETHANE
Acetaldehyde	D	C	A	D	B	C	D	A	D	D
Acetamide	A	B	A	B	B	D	A	A	B	D
Acetic Acid, Glacial	C	D	A	C	B	B	D	B	C	D
Acetic Acid, 30%	B	A	A	B	A	B	B	B	D	D
Acetic Anhydride	C	B	B	D	C	B	D	B	D	D
Acetone	D	C	A	D	C	C	D	A	D	D
Acetophenone	D	D	A	D	D	D	D	A	D	D
Acetyl Chloride	D	D	D	A	C	D	A	D	D	D
Acetylene	A	B	A	A	B	B	E	A	A	D
Acrylonitrile	D	D	D	C	D	D	E	D	B	D
Adipic Acid	A	A	A	E	E	A	A	A	D	E
Alkazene (Dibromoethyl-benzene)	D	D	D	B	D	D	B	D	B	D
Alum-NH ₃ -Cr-K (aq)	A	A	A	D	A	A	D	A	A	E
Aluminum Acetate (aq)	B	B	A	D	D	B	D	A	A	D
Aluminum Chloride (aq)	A	A	A	A	B	A	A	A	A	C
Aluminum Fluoride (aq)	A	A	A	A	B	A	A	A	A	C
Aluminum Nitrate (aq)	A	A	A	A	B	A	E	A	A	C
Aluminum Phosphate (aq)	A	A	A	A	A	A	E	A	D	E
Aluminum Sulfate (aq)	A	A	A	A	A	A	A	A	A	D
Ammonia, Anhydrous	B	A	A	D	C	D	D	A	A	D
Ammonia Gas (cold)	A	A	A	D	A	A	D	A	A	E
Ammonia Gas (hot)	D	B	B	D	A	D	D	B	A	E
Ammonium Carbonate (aq)	D	A	B	E	E	A	E	A	A	D
Ammonium Chloride (aq)	A	A	A	A	E	A	E	A	A	A
Ammonium Hydroxide(conc.)	D	A	A	B	A	D	B	A	A	D
Ammonium Nitrate (aq)	A	A	A	E	E	B	E	A	A	E
Ammonium Nitrite (aq)	A	A	A	E	B	A	E	A	A	E
Ammonium Persulfate (aq)	D	A	A	E	E	D	E	A	A	D
Ammonium Phosphate (aq)	A	A	A	E	A	A	E	A	A	E
Ammonium Sulfate (aq)	A	A	A	D	E	A	E	A	A	E
Amyl Acetate(Banana Oil)	D	D	A	D	D	D	D	C	D	D
Amyl Alcohol	B	B	A	B	D	B	A	A	A	D
Amyl Borate	A	A	D	A	E	D	E	D	A	E
Amyl Chloronaphthalene	D	D	D	A	D	D	B	D	B	E
Amyl Naphthalene	D	D	D	A	D	D	A	D	B	D
Aniline	D	D	A	C	D	D	C	A	A	D
Aniline Dyes	D	B	A	B	C	B	B	B	A	D
Aniline Hydrochloride	B	D	B	B	D	D	B	B	A	D
Animal Fats	A	B	B	A	B	D	A	B	A	B
Ansul Ether(Anesthetics)	C	D	C	D	D	D	C	C	D	B
Aqua Regia	D	D	C	B	D	D	C	D	B	E
Aroclor, 1248	C	D	C	A	B	D	B	C	A	D
Aroclor, 1254	D	D	C	A	C	D	B	D	A	D
Aroclor, 1260	A	A	A	A	B	A	A	A	A	D
Arsenic Acid	A	A	A	A	A	A	A	A	A	C
Arsenic Trichloride (aq)	A	A	C	E	E	D	E	C	D	E
Askarel	B	D	D	A	D	D	B	D	A	D
Asphalt	B	B	D	A	D	D	B	D	A	B
ASTM Fuel A	A	B	D	A	D	D	A	D	B	A
ASTM Fuel B	A	C	D	A	D	D	A	D	D	B
ASTM Fuel C	A	C	D	A	D	D	A	D	D	D
ASTM Fuel D	A	C	D	A	D	D	A	D	D	E
ASTM Oil One	A	A	D	A	C	D	A	D	A	A
ASTM Oil Two	A	B	D	A	C	D	A	D	A	B

A. SATISFACTORY B. FAIR C. SEVERE EFFECT – EXCEPT FOR SOME STATIC APPLICATIONS D. UNSATISFACTORY E. INSUFFICIENT INFORMATION

- Notes:**
- (1) Temperature, concentrations, impurities, and other chemicals present can effect the chemical resistance of an elastomer. It is not possible to test in all chemicals and therefore some chemical resistance indicators are based on the manufacturer's best estimates known about various classes and the composition of the elastomer. Therefore, manufacturers do not certify results from a performance standpoint but state they should be used only as indicators of chemical resistance. APG assumes no responsibility whatsoever.
 - (2) The information contained in these tables was derived from several sources and is to be used as a general guide only. Compounds suitable for any specific application rests solely by the end user. APG assumes no responsibility whatsoever.

Compound Selection for Fluids and Chemicals (Continued)

	NITRILE	CHLORO-PRENE	ETHYLENE PROPYLENE (EPR)	FLUORO-ELASTOMER	SILICONE	STYRENE BUTADIENE (SBR)	FLUORO-SILICONE	BUTYL	AFLAS®	URETHANE
ASTM Oil Three	A	B	D	A	C	D	A	D	A	B
Barium Chloride (aq)	A	A	A	A	A	A	A	A	A	A
Barium Hydroxide (aq)	A	A	A	A	A	A	A	A	A	D
Barium Sulfate (aq)	A	A	A	A	A	A	A	A	A	E
Barium Sulfide (aq)	A	A	A	A	A	B	A	A	A	A
Beer	A	A	A	A	A	A	A	A	A	B
Beet Sugar Liquors	A	B	A	A	A	A	A	A	A	D
Benzaldehyde	D	D	A	D	B	D	C	A	B	D
Benzene	D	D	D	A	D	D	C	D	C	D
Benzene Sulfonic Acid	D	B	C	A	D	D	B	D	D	D
Benzine (Ligroin) (Nitrobenzene)	A	B	D	A	D	D	A	D	B	B
Benzoic Acid	C	D	C	A	C	D	B	D	A	D
Benzoyl Chloride	D	D	D	A	E	D	B	D	A	E
Benzyl Alcohol	D	B	A	A	B	D	B	A	A	D
Benzyl Benzoate	D	D	B	A	E	D	A	B	A	D
Benzyl Chloride	D	D	D	A	D	D	B	D	A	D
Biphenyl (Phenylbenzene)	D	D	D	A	D	D	B	D	D	D
Bleach Solutions	D	D	A	A	B	D	B	A	A	D
Borax	B	A	A	A	B	B	B	A	A	A
Bordeaux Mixture	B	B	A	A	B	B	B	A	A	D
Boric Acid	A	A	A	A	A	A	A	A	A	A
Brine	A	A	A	A	A	A	A	A	D	B
Bromine, Anhydrous	D	D	D	A	D	D	B	D	E	D
Bromine Trifluoride	D	D	D	D	D	D	D	D	E	D
Bromine Water	D	D	B	A	D	D	B	C	A	D
Bromobenzene	D	D	D	A	D	D	A	D	D	D
Bunker Oil	A	D	D	A	B	D	A	D	A	B
Butadiene	D	D	C	A	D	D	B	D	E	D
Butane	A	A	D	A	D	D	A	D	B	A
Butter (Animal Fat)	A	B	A	A	B	D	A	B	A	A
Butyl Acetate	D	D	C	D	D	D	D	C	D	D
Butyl Acetyl Ricinoleate	C	B	A	A	E	D	B	A	A	D
Butyl Acrylate	D	D	D	D	E	D	D	D	D	E
Butyl Alcohol	A	A	B	A	B	A	B	B	A	D
Butyl Amine	C	D	B	D	D	D	D	C	B	D
Butyl Benzoate	D	D	B	A	E	B	A	B	A	E
Butyl Carbitol	D	C	A	A	D	D	D	A	B	E
Butyl Cellosolve	D	C	A	D	E	D	D	A	E	D
Butyl Oleate	D	D	B	A	E	D	B	B	A	E
Butyl Stearate	B	D	C	A	E	D	B	C	A	E
Butylene	B	C	D	A	D	D	B	D	A	D
Butyraldehyde	D	C	B	D	D	D	D	B	D	D
Calcium Acetate (aq)	B	B	A	D	D	D	D	A	A	D
Calcium Bisulfite (aq)	B	A	A	A	A	D	A	D	A	C
Calcium Chloride (aq)	A	A	A	A	A	A	A	A	A	A
Calcium Hydroxide (aq)	A	A	A	A	A	A	A	A	A	B
Calcium Hypochlorite(aq)	B	C	A	A	B	C	B	A	A	D
Calcium Nitrate (aq)	A	A	A	A	B	A	A	A	A	A
Calcium Sulfide (aq)	A	A	A	A	B	B	A	A	A	A
Cane Sugar Liquors	A	A	A	A	A	A	A	A	A	D
Carbamate	C	B	B	A	E	D	A	B	A	D
Carbitol	B	B	B	B	B	B	B	B	A	D
Carbolic Acid (Phenol)	D	C	B	A	D	E	A	B	A	C
Carbon Bisulfide	C	D	D	A	D	D	A	D	A	E

A. SATISFACTORY B. FAIR C. SEVERE EFFECT – EXCEPT FOR SOME STATIC APPLICATIONS D. UNSATISFACTORY E. INSUFFICIENT INFORMATION

- Notes:**
- (1) Temperature, concentrations, impurities, and other chemicals present can effect the chemical resistance of an elastomer. It is not possible to test in all chemicals and therefore some chemical resistance indicators are based on the manufacturer's best estimates known about various classes and the composition of the elastomer. Therefore, manufacturers do not certify results from a performance standpoint but state they should be used only as indicators of chemical resistance. APG assumes no responsibility whatsoever.
 - (2) The information contained in these tables was derived from several sources and is to be used as a general guide only. Compounds suitable for any specific application rests solely by the end user. APG assumes no responsibility whatsoever.

Compound Selection for Fluids and Chemicals (Continued)

	NITRILE	CHLORO-PRENE	ETHYLENE PROPYLENE (EPR)	FLUORO-ELASTOMER	SILICONE	STYRENE BUTADIENE (SBR)	FLUORO-SILICONE	BUTYL	AFLAS®	URETHANE
Carbon Dioxide	A	B	B	A	B	B	A	B	A	A
Carbonic Acid	B	A	A	A	A	B	A	A	A	A
Carbon Monoxide	A	B	A	A	A	B	B	A	A	A
Carbon Tetrachloride	C	D	D	A	D	D	C	D	C	D
Castor Oil	A	A	B	A	A	A	A	B	A	A
Cellosolve	D	D	B	C	D	D	D	B	A	D
Cellosolve Acetate	D	D	B	D	D	D	D	B	C	D
Cellulube (Fryquel)	D	D	A	A	E	D	C	A	B	D
China Wood Oil (Tung Oil)	A	B	C	A	D	D	B	C	A	C
Chlorine (dry)	D	C	D	A	D	D	A	D	E	E
Chlorine (wet)	D	C	C	A	D	D	B	C	E	E
Chlorine Dioxide	D	D	C	A	E	D	B	C	E	D
Chlorine Trifluoride	D	D	D	D	D	D	C	D	E	D
Chloroacetic Acid	D	D	A	D	E	D	D	B	E	E
Chloroacetone	D	C	A	D	D	D	D	B	D	D
Chlorobenzene	D	D	D	A	D	D	B	D	C	D
Chlorobromomethane	D	D	B	A	D	D	B	B	E	D
Chlorobutadiene	D	D	D	A	D	D	B	D	C	D
Chlorododecane	D	D	D	A	D	D	A	D	B	D
Chloroform	D	D	D	A	D	D	D	D	D	D
O-Chloronaphthalene	D	D	D	A	D	D	B	D	E	D
1-Chloro 1-Nitro Ethane	D	D	D	D	D	D	D	D	E	D
Chlorosulfonic Acid	D	D	D	D	D	D	D	D	B	D
Chlorotoluene	D	D	D	A	D	D	B	D	D	D
Chlorox (Sodium Hypochlorite NaOCl)	B	A	B	A	B	D	B	B	A	D
Chrome Plating Solutions	D	D	B	A	B	D	B	B	A	D
Chromic Acid	D	C	C	A	C	D	C	C	E	E
Citric Acid	A	A	A	A	A	A	A	A	A	A
Coal Tar (Creosote)	A	B	D	A	D	D	A	D	E	C
Cobalt Chloride (aq)	A	A	A	A	B	A	A	A	A	E
Coconut Oil	A	B	C	A	A	D	A	C	A	C
Cod Liver Oil	A	B	A	A	B	D	A	A	A	A
Coke Oven Gas	D	D	D	A	B	D	B	D	A	D
Copper Acetate (aq)	B	B	A	D	D	D	D	A	D	D
Copper Chloride (aq)	A	B	A	A	A	A	A	A	A	A
Copper Cyanide (aq)	A	A	A	A	A	A	A	A	B	A
Copper Sulfate (aq)	A	A	A	A	A	B	A	B	A	E
Corn Oil	A	C	C	A	A	D	A	C	A	A
Cottonseed Oil	A	B	B	A	A	D	A	C	A	A
Creosote (coal tar)	A	B	D	A	D	D	A	D	A	C
Cresol	D	C	D	A	D	D	B	D	A	E
Cresylic Acid	D	C	D	A	D	D	B	D	A	D
Cumene	D	D	D	A	D	D	B	D	C	D
Cyclohexane	A	C	D	A	D	D	B	D	B	A
Cyclohexanol	C	A	C	A	D	D	A	D	A	E
Cyclohexanone	D	D	B	D	D	D	D	B	C	D
P-Cymene	D	D	D	A	D	D	B	D	C	D
Decalin	D	D	D	A	D	D	A	D	B	E
Decane	A	D	D	A	B	D	A	D	B	B
Denatured Alcohol	A	A	A	A	A	A	A	A	A	D
Detergent Solutions	A	B	A	A	A	B	A	A	A	D
Developing Fluids	A	A	B	A	A	B	A	A	A	E
Diacetone	D	D	A	D	D	D	D	A	C	D
Diacetone Alcohol	D	B	A	D	B	D	D	A	C	D

A. SATISFACTORY B. FAIR C. SEVERE EFFECT – EXCEPT FOR SOME STATIC APPLICATIONS D. UNSATISFACTORY E. INSUFFICIENT INFORMATION

- Notes:**
- (1) Temperature, concentrations, impurities, and other chemicals present can effect the chemical resistance of an elastomer. It is not possible to test in all chemicals and therefore some chemical resistance indicators are based on the manufacturer's best estimates known about various classes and the composition of the elastomer. Therefore, manufacturers do not certify results from a performance standpoint but state they should be used only as indicators of chemical resistance. APG assumes no responsibility whatsoever.
 - (2) The information contained in these tables was derived from several sources and is to be used as a general guide only. Compounds suitable for any specific application rests solely by the end user. APG assumes no responsibility whatsoever.

Compound Selection for Fluids and Chemicals (Continued)

	NITRILE	CHLORO-PRENE	ETHYLENE PROPYLENE (EPR)	FLUORO-ELASTOMER	SILICONE	STYRENE BUTADIENE (SBR)	FLUORO-SILICONE	BUTYL	AFLAS®	URETHANE
Dibenzyl Ether	D	C	B	D	E	D	E	B	D	B
Dibenzyl Sebecate	D	D	B	B	C	D	C	B	A	B
Dibromoethyl benzene (Alkazene)	D	D	D	B	D	D	B	D	D	D
Dibutyl Amine	D	D	C	D	C	D	D	D	A	D
Dibutyl Ether	D	C	C	C	D	D	C	C	D	B
Dibutyl Phthalate	D	D	B	C	B	D	C	C	B	C
Dibutyl Sebecate	D	D	B	B	B	D	B	B	B	D
O-Dichlorobenzene	D	D	D	A	D	D	B	D	D	D
Dichloro-Isopropyl Ether	D	D	C	C	D	D	C	D	D	B
Dicyclohexylamine	C	D	D	D	E	D	D	D	B	D
Diesel Oil	A	C	D	A	D	D	A	D	A	C
Diethylamine	B	B	B	D	B	B	D	B	B	C
Diethyl Benzene	D	D	D	A	D	D	C	D	E	E
Diethyl Ether	D	C	D	D	D	D	C	D	D	A
Diethylene Glycol	A	A	A	A	B	A	A	A	A	D
Diethyl Sebecate	B	D	B	B	B	D	B	B	B	D
Diisobutylene	B	D	D	A	D	D	C	D	B	D
Diisopropyl Benzene	D	D	D	A	E	D	B	D	E	E
Diisopropyl Ketone	D	D	A	D	D	D	D	A	D	D
Diisopropylidene Acetone	D	D	C	D	D	D	D	C	E	E
Dimethyl Aniline (Xylidine)	C	C	B	D	D	C	D	C	E	E
Dimethyl Ether (Methyl Ether)	A	C	D	A	A	D	A	D	E	E
Dimethyl Formamide	B	C	B	D	B	D	D	B	B	D
Dimethyl Phthalate	D	D	B	B	E	D	B	B	B	E
Dinitrotoluene	D	D	D	D	D	D	D	D	D	D
Diocetyl Phthalate	C	D	B	B	C	D	B	B	B	D
Diocetyl Sebecate	D	D	B	B	C	D	C	B	B	B
Dioxane	D	D	B	D	D	D	C	B	D	D
Dioxolane	D	D	B	D	D	D	D	C	D	D
Dipentene	A	D	D	A	D	D	C	D	C	D
Diphenyl (Phenylbenzene)	D	D	D	A	D	D	B	D	D	D
Diphenyl Oxides	D	D	D	A	C	D	B	D	B	D
Dowtherm Oil	D	D	D	A	C	D	B	D	E	E
Dry Cleaning Fluids	C	D	D	A	D	D	B	D	C	D
Epichlorohydrin	D	D	B	D	D	D	D	B	D	D
Ethane	A	B	D	A	D	D	B	D	A	C
Ethanolamine	B	B	B	D	B	B	D	B	A	C
Ethyl Acetate	D	C	B	D	B	D	D	B	D	D
Ethyl Acetoacetate	D	C	B	D	B	C	D	B	D	D
Ethyl Acrylate	D	D	B	D	B	D	D	B	D	D
Ethyl Alcohol	A	A	A	C	A	A	A	A	A	D
Ethyl Benzene	D	D	D	A	D	D	A	D	D	D
Ethyl Benzoate	D	D	A	A	D	A	A	A	C	D
Ethyl Cellosolve	D	D	B	D	D	D	D	D	A	D
Ethyl Cellulose	B	B	B	D	C	B	D	B	A	B
Ethyl Chloride	A	D	C	A	D	D	A	D	B	B
Ethyl Chlorocarbonate	D	D	B	A	D	D	B	C	B	D
Ethyl Chloroformate	D	D	B	D	D	D	D	C	B	D
Ethyl Ether	C	C	C	D	D	D	C	C	D	D
Ethyl Formate	D	B	B	A	E	D	A	B	A	D
Ethyl Mercaptan	D	C	C	B	C	D	E	D	B	E
Ethyl Oxalate	D	C	A	A	D	A	B	A	E	E
Ethyl Pentachlorobenzene	D	D	D	A	D	D	B	D	D	D
Ethyl Silicate	A	A	A	A	E	B	A	A	A	E

A. SATISFACTORY B. FAIR C. SEVERE EFFECT – EXCEPT FOR SOME STATIC APPLICATIONS D. UNSATISFACTORY E. INSUFFICIENT INFORMATION

- Notes:**
- (1) Temperature, concentrations, impurities, and other chemicals present can effect the chemical resistance of an elastomer. It is not possible to test in all chemicals and therefore some chemical resistance indicators are based on the manufacturer's best estimates known about various classes and the composition of the elastomer. Therefore, manufacturers do not certify results from a performance standpoint but state they should be used only as indicators of chemical resistance. APG assumes no responsibility whatsoever.
 - (2) The information contained in these tables was derived from several sources and is to be used as a general guide only. Compounds suitable for any specific application rests solely by the end user. APG assumes no responsibility whatsoever.

Compound Selection for Fluids and Chemicals (Continued)

	NITRILE	CHLORO-PRENE	ETHYLENE PROPYLENE (EPR)	FLUORO-ELASTOMER	SILICONE	STYRENE BUTADIENE (SBR)	FLUORO-SILICONE	BUTYL	AFLAS®	URETHANE
Ethylene	A	C	B	A	E	C	A	B	E	E
Ethylene Chloride	D	D	C	B	D	D	C	C	A	D
Ethylene Chlorohydrin	D	B	B	A	C	B	B	B	A	D
Ethylene Diamine	A	A	A	D	A	B	D	A	A	D
Ethylene Dichloride	D	D	C	A	D	D	C	C	E	D
Ethylene Glycol	A	A	A	A	A	A	A	A	A	B
Ethylene Oxide	D	D	C	D	D	D	D	C	D	D
Ethylene Trichloride	D	D	C	A	D	D	C	C	E	D
Fatty Acids	B	B	C	A	C	D	E	C	A	E
Ferric Chloride (aq)	A	A	A	A	B	A	A	A	A	A
Ferric Nitrate (aq)	A	A	A	A	C	A	A	A	A	A
Ferric Sulfate (aq)	A	A	A	A	B	A	A	A	A	E
Fish Oil	A	D	D	A	A	D	A	D	E	E
Fluorinated Cyclic Ethers	E	D	A	E	E	D	E	A	E	E
Fluorine (liquid)	D	D	D	E	D	D	E	D	E	E
Fluorobenzene	D	D	D	A	D	D	B	D	E	E
Fluoroboric Acid	A	A	A	E	E	A	E	A	E	E
Fluorocarbon Oils	E	B	A	E	E	B	E	A	E	E
Fluorolube	A	B	A	B	A	C	B	A	B	E
Fluorosilicic Acid	A	B	B	A	D	C	D	B	E	E
Formaldehyde (RT)	C	B	A	D	B	B	D	A	B	D
Formic Acid	B	A	A	C	B	A	C	A	E	E
Freon 11	B	C	D	A	D	D	B	D	D	E
Freon 12	A	A	B	B	D	A	C	B	D	A
Freon 13	A	A	A	A	D	A	D	A	D	E
Freon 21	D	D	D	D	D	D	E	D	D	E
Freon 22	D	A	A	D	D	A	D	A	D	D
Freon 31	D	B	A	D	E	B	E	A	D	E
Freon 32	A	A	A	D	E	A	E	A	D	E
Freon 112	B	C	D	A	D	C	E	D	D	E
Freon 113	A	A	C	B	D	B	D	D	D	A
Freon 114	A	A	A	B	D	A	B	A	D	E
Freon 115	A	A	A	B	E	A	E	A	D	E
Freon 142b	A	A	B	D	E	B	E	A	D	E
Freon 152a	A	A	A	D	E	A	E	A	D	E
Freon 218	A	A	A	A	E	A	E	A	D	E
Freon C316	A	A	A	E	E	A	E	A	D	E
Freon C318	A	A	A	B	E	A	E	A	D	E
Freon 13B1	A	A	A	A	D	A	E	A	D	E
Freon 114B2	B	B	D	B	D	C	E	D	D	E
Freon 502	B	A	A	B	E	A	E	A	D	E
Freon TF	A	A	D	B	D	C	E	D	D	A
Freon T-WD602	B	B	B	A	D	C	E	B	D	E
Freon TMC	B	C	C	A	C	D	E	C	D	E
Freon T-P35	A	A	A	A	A	A	E	A	E	E
Freon TA	A	B	B	C	C	C	E	B	E	E
Freon TC	A	A	B	A	D	C	E	B	E	E
Freon MF	A	C	D	B	D	D	E	D	D	C
Freon BF	B	C	D	A	D	D	E	D	D	E
Fuel Oil	A	B	D	A	D	D	A	D	A	B
Fumaric Acid	A	B	B	A	B	C	A	B	A	E
Furan, Furfuran	D	D	C	E	E	D	E	D	E	E
Furfural	D	C	B	D	D	D	E	B	E	C
Fyrquel (Cellulube)	D	D	A	A	E	D	C	A	E	D

A. SATISFACTORY B. FAIR C. SEVERE EFFECT – EXCEPT FOR SOME STATIC APPLICATIONS D. UNSATISFACTORY E. INSUFFICIENT INFORMATION

- Notes:**
- (1) Temperature, concentrations, impurities, and other chemicals present can effect the chemical resistance of an elastomer. It is not possible to test in all chemicals and therefore some chemical resistance indicators are based on the manufacturer's best estimates known about various classes and the composition of the elastomer. Therefore, manufacturers do not certify results from a performance standpoint but state they should be used only as indicators of chemical resistance. APG assumes no responsibility whatsoever.
 - (2) The information contained in these tables was derived from several sources and is to be used as a general guide only. Compounds suitable for any specific application rests solely by the end user. APG assumes no responsibility whatsoever.

Compound Selection for Fluids and Chemicals (Continued)

	NITRILE	CHLORO-PRENE	ETHYLENE PROPYLENE (EPR)	FLUORO-ELASTOMER	SILICONE	STYRENE BUTADIENE (SBR)	FLUORO-SILICONE	BUTYL	AFLAS®	URETHANE
Gallic Acid	B	B	B	A	E	B	A	B	A	D
Gasoline	B	C	D	A	D	D	A	D	C	B
Gelatin	A	A	A	A	A	A	A	A	A	D
Glauber's Salt (aq)	D	B	B	A	E	D	A	B	A	E
Glucose	A	A	A	A	A	A	A	A	A	D
Glue	A	A	A	A	A	B	A	B	E	E
Glycerin	A	A	A	A	A	A	A	A	A	D
Glycols	A	A	A	A	A	A	A	A	A	D
Green Sulfate Liquor	B	B	A	A	A	B	B	A	A	D
Halowax Oil	D	D	D	A	D	D	A	D	A	E
N-Hexaldehyde	D	A	A	D	B	D	D	B	D	B
Hexane	A	B	D	A	D	D	A	D	B	B
N-Hexene-1	B	B	D	A	D	D	A	D	B	B
Hexyl Alcohol	A	B	C	A	B	B	B	C	A	D
Hydrazine	B	B	A	D	C	A	D	A	E	D
Hydraulic Oil(Petroleum)	A	B	D	A	C	D	A	D	A	A
Hydrobromic Acid	D	D	A	A	D	D	C	A	A	D
Hydrobromic Acid 40%	D	B	A	A	D	D	C	A	A	D
Hydrochloric Acid (cold) 37%	C	B	A	A	C	B	B	A	E	D
Hydrochloric Acid (hot) 37%	D	D	C	B	D	D	C	C	E	D
Hydrocyanic Acid	B	B	A	A	C	B	B	A	A	E
Hydrofluoric Acid (conc.) cold	D	D	C	A	D	D	D	C	A	E
Hydrofluoric Acid (conc.) hot	D	D	D	C	D	D	D	D	C	E
Hydrofluoric Acid -Anhydrous	D	D	C	D	D	D	D	C	D	E
Hydrofluosilicic Acid	B	B	B	A	D	C	D	B	A	E
Hydrogen Gas	A	A	A	A	C	A	C	A	A	A
Hydrogen Peroxide (90%)	D	D	B	B	B	D	B	C	A	A
Hydrogen Sulfide (wet) cold	D	B	A	D	C	D	C	A	A	E
Hydrogen Sulfide (wet) hot	D	C	A	D	C	D	C	A	B	E
Hydroquinone	C	D	B	B	E	D	B	B	E	E
Hypochlorous Acid	D	D	B	A	E	D	E	B	E	E
Iodine Pentafluoride	D	D	D	D	D	D	D	D	D	D
Iodoform	E	D	D	E	E	D	E	D	E	E
Isobutyl Alcohol	B	A	A	A	A	B	B	A	A	D
Isooctane	A	B	D	A	D	D	A	D	B	B
Isophorone	D	D	B	D	D	D	D	C	C	D
Isopropyl Acetate	D	D	B	D	D	D	D	B	D	D
Isopropyl Alcohol	B	B	A	A	A	B	B	A	A	D
Isopropyl Chloride	D	D	D	A	D	D	B	D	E	D
Isopropyl Ether	B	C	D	D	D	D	C	D	D	B
Kerosene	A	B	D	A	D	D	A	D	A	A
Lacquers	D	D	D	D	D	D	D	D	D	D
Lacquer Solvents	D	D	D	D	D	D	D	D	D	D
Lactic Acid (cold)	A	A	A	A	A	A	A	A	A	E
Lactic Acid (hot)	D	D	D	A	B	D	B	D	A	E
Lard	A	B	B	A	B	D	A	B	A	A
Lavender Oil	B	D	D	A	D	D	B	D	A	E
Lead Acetate (aq)	B	B	A	D	D	D	D	A	D	D
Lead Nitrite (aq)	A	A	A	E	B	A	A	A	E	E
Lead Sulfamate (aq)	B	A	A	A	B	B	A	A	A	E
Ligroin (Benzine) (Nitrobenzine)	A	B	D	A	D	D	A	D	B	B
Lime Bleach	A	B	A	A	B	B	A	A	A	E
Lime Sulfur	D	A	A	A	A	D	A	A	A	E
Lindol (Hydraulic fluid)	D	D	A	B	C	D	C	A	A	D

A. SATISFACTORY B. FAIR C. SEVERE EFFECT – EXCEPT FOR SOME STATIC APPLICATIONS D. UNSATISFACTORY E. INSUFFICIENT INFORMATION

- Notes:**
- (1) Temperature, concentrations, impurities, and other chemicals present can effect the chemical resistance of an elastomer. It is not possible to test in all chemicals and therefore some chemical resistance indicators are based on the manufacturer's best estimates known about various classes and the composition of the elastomer. Therefore, manufacturers do not certify results from a performance standpoint but state they should be used only as indicators of chemical resistance. APG assumes no responsibility whatsoever.
 - (2) The information contained in these tables was derived from several sources and is to be used as a general guide only. Compounds suitable for any specific application rests solely by the end user. APG assumes no responsibility whatsoever.

Compound Selection for Fluids and Chemicals (Continued)

	NITRILE	CHLORO-PRENE	ETHYLENE PROPYLENE (EPR)	FLUORO-ELASTOMER	SILICONE	STYRENE BUTADIENE (SBR)	FLUORO-SILICONE	BUTYL	AFLAS®	URETHANE
Linoleic Acid	B	D	D	B	B	D	E	D	A	E
Linseed Oil	A	B	C	A	A	D	A	C	A	B
Liquefied Petroleum Gas	A	B	D	A	C	D	C	D	C	A
Lubricating Oils(petroleum)	A	B	D	A	D	D	A	D	A	B
Lye	B	B	A	B	B	B	A	A	A	D
Magnesium Chloride (aq)	A	A	A	A	A	A	A	A	A	A
Magnesium Hydroxide (aq)	B	A	A	A	E	B	E	A	A	D
Magnesium Sulfate (aq)	A	A	A	A	A	B	A	A	A	E
Maleic Acid	D	C	B	A	E	C	E	B	A	E
Maleic Anhydride	D	C	B	D	E	B	E	B	A	E
Malic Acid	A	C	B	A	B	C	A	B	A	E
Mercury Chloride (aq)	A	A	A	A	E	A	E	A	A	E
Mercury	A	A	A	A	E	A	E	A	A	E
Mesityl Oxide	D	D	B	D	D	D	D	B	C	D
Methane	A	B	D	B	D	D	B	D	B	C
Methyl Acetate	D	B	A	D	D	C	D	A	D	D
Methyl Acrylate	D	B	B	D	D	D	D	B	E	D
Methylacrylic Acid	D	B	B	D	D	D	D	B	E	D
Methyl Alcohol	A	A	A	D	A	A	A	A	A	D
Methyl Bromide	B	D	D	A	E	D	A	D	A	E
Methyl Butyl Ketone	D	D	A	D	C	D	D	A	C	D
Methyl Cellosolve	C	C	B	D	D	D	D	B	E	D
Methyl Chloride	D	D	C	B	D	D	B	C	E	D
Methyl Cyclopentane	D	D	D	B	D	D	B	D	B	D
Methylene Chloride	D	D	C	B	D	D	B	D	E	D
Methyl Ether	A	C	D	A	A	D	A	D	C	E
Methyl Ethyl Ketone	D	C	A	D	D	D	D	B	D	D
Methyl Formate	D	B	B	E	E	D	E	B	E	E
Methyl Isobutyl Ketone	D	D	B	D	D	D	D	C	D	D
Methyl Methacrylate	D	D	C	D	D	D	D	D	E	E
Methyl Oleate	D	D	B	B	E	D	B	B	A	E
Methyl Salicylate	D	D	B	E	E	C	E	B	E	E
Milk	A	A	A	A	A	A	A	A	A	D
Mineral Oil	A	B	C	A	B	D	A	C	A	A
Monochlorobenzene	D	D	D	A	D	D	B	D	D	D
Monomethyl Aniline	D	D	B	B	E	D	E	B	E	D
Monoethanol Amine	D	D	A	D	B	B	D	B	A	D
Monomethyl Ether	A	C	D	A	A	D	A	D	E	E
Monovinyl Acetylene	A	B	A	A	B	B	E	B	A	E
Mustard Gas	E	A	A	E	A	B	E	A	E	E
Naphtha	B	C	D	A	D	D	B	D	B	B
Naphthalene	D	D	D	A	D	D	A	D	C	B
Naphthalenic Acid	B	D	D	A	D	D	A	D	B	E
Natural Gas	A	A	D	A	A	A	C	D	A	B
Neats Foot Oil	A	D	B	A	B	D	A	B	A	A
Neville Acid	D	D	B	A	D	D	B	B	A	E
Nickel Acetate (aq)	B	B	A	D	D	D	D	A	D	D
Nickel Chloride (aq)	A	A	A	A	A	A	A	A	A	C
Nickel Sulfate (aq)	A	A	A	A	A	B	A	A	A	C
Niter Cake	A	A	A	A	A	A	A	A	A	A
Nitric Acid (conc.)	D	D	D	C	D	D	C	D	B	D
Nitric Acid (dilute)	D	B	B	A	B	D	B	B	E	D
Nitric Acid - Red Fuming	D	D	D	D	D	D	D	D	C	E
Nitrobenzene	D	D	A	B	D	D	D	A	E	D

A. SATISFACTORY B. FAIR C. SEVERE EFFECT – EXCEPT FOR SOME STATIC APPLICATIONS D. UNSATISFACTORY E. INSUFFICIENT INFORMATION

- Notes:**
- (1) Temperature, concentrations, impurities, and other chemicals present can effect the chemical resistance of an elastomer. It is not possible to test in all chemicals and therefore some chemical resistance indicators are based on the manufacturer's best estimates known about various classes and the composition of the elastomer. Therefore, manufacturers do not certify results from a performance standpoint but state they should be used only as indicators of chemical resistance. APG assumes no responsibility whatsoever.
 - (2) The information contained in these tables was derived from several sources and is to be used as a general guide only. Compounds suitable for any specific application rests solely by the end user. APG assumes no responsibility whatsoever.

Compound Selection for Fluids and Chemicals (Continued)

	NITRILE	CHLORO-PRENE	ETHYLENE PROPYLENE (EPR)	FLUORO-ELASTOMER	SILICONE	STYRENE BUTADIENE (SBR)	FLUORO-SILICONE	BUTYL	AFLAS®	URETHANE
Nitrobenzene (Ilgroin)	A	B	D	A	D	D	A	D	E	D
Nitroethane	D	C	B	D	D	B	D	B	E	D
Nitrogen	A	A	A	A	A	A	A	A	A	A
Nitrogen Tetroxide	D	D	C	D	D	D	D	C	E	D
Nitromethane	D	B	B	D	D	B	D	B	E	D
Octachlorotoluene	D	D	D	A	D	D	B	D	C	D
Octadecane	A	B	D	A	D	D	A	D	B	A
N-Octane	B	B	D	A	D	D	B	D	B	D
Octyl Alcohol	B	A	C	A	B	B	B	C	A	D
Oleic Acid	C	C	D	B	D	D	E	D	A	B
Oleum Spirits	B	C	D	A	D	D	B	D	A	C
Olive Oil	A	B	B	A	C	D	A	B	A	A
O-Dichlorobenzene	D	D	D	A	D	D	B	D	D	D
Oxalic Acid	B	B	A	A	B	B	A	A	A	E
Oxygen - Cold	B	A	A	A	A	B	A	A	A	A
Oxygen - (200-400°F)	D	D	C	B	B	D	D	B	E	D
Ozone	D	C	A	A	A	D	B	D	A	A
Paint Thinner, Duco	D	D	D	B	D	D	B	D	B	D
Palmitic Acid	A	B	B	A	D	B	A	B	A	A
Peanut Oil	A	C	C	A	A	D	A	C	A	B
Perchloric Acid	D	B	B	A	D	D	A	B	A	D
Perchloroethylene	B	D	D	A	D	D	B	D	E	D
Petroleum - below 250°F	A	B	D	A	B	D	B	D	A	B
Petroleum - above 250°F	D	B	D	B	D	D	D	D	B	D
Phenol (Carbolic Acid)	D	C	B	A	D	E	A	B	E	D
Phenylbenzene (Biphenyl)	D	D	D	A	D	D	B	D	D	D
Phenyl Ethyl Ether	D	D	D	D	D	D	D	D	D	D
Phenyl Hydrazine	D	D	B	A	E	B	E	B	A	E
Phorone (Diisopropylidene Acetone)	D	D	C	D	D	D	D	C	D	D
Phosphoric Acid - 20%	B	B	A	A	B	B	B	B	A	D
Phosphoric Acid - 45%	D	B	A	A	C	C	B	B	A	D
Phosphorus Trichloride	D	D	A	A	E	D	A	A	A	E
Pickling Solution	D	D	C	B	D	D	D	C	B	D
Picric Acid	B	A	B	A	D	B	B	B	A	E
Pinene	B	C	D	A	D	D	B	D	A	B
Pine Oil	A	D	D	A	D	D	A	D	A	E
Piperidine	D	D	A	D	D	D	D	D	E	D
Plating Solution - Chrome	E	D	A	A	D	D	E	A	E	E
Plating Solution - Others	A	D	A	A	D	D	E	A	E	E
Polyvinyl Acetate Emulsion	E	B	A	E	E	D	E	A	E	E
Potassium Acetate (aq)	B	B	A	D	D	D	D	A	E	D
Potassium Chloride (aq)	A	A	A	A	A	A	A	A	A	A
Potassium Cupro Cyanide (aq)	A	A	A	A	A	A	A	A	A	A
Potassium Cyanide (aq)	A	A	A	A	A	A	A	A	A	A
Potassium Dichromate (aq)	A	A	A	A	A	B	A	A	A	B
Potassium Hydroxide (aq)	B	B	A	D	C	B	C	A	A	D
Potassium Nitrate (aq)	A	A	A	A	A	A	A	A	A	A
Potassium Sulfate (aq)	A	A	A	A	A	A	A	A	A	A
Producer Gas	A	B	D	A	B	D	B	D	A	A
Propane	A	B	D	A	D	D	B	D	A	C
i-Propyl Acetate	D	D	B	D	D	D	D	B	D	D
n-Propyl Acetate	D	D	B	D	D	D	D	B	D	E
Propyl Acetone (Methyl Butyl Ketone)	D	D	A	D	C	D	D	A	C	D
Propyl Alcohol	A	A	A	A	A	A	A	A	A	D

A. SATISFACTORY B. FAIR C. SEVERE EFFECT – EXCEPT FOR SOME STATIC APPLICATIONS D. UNSATISFACTORY E. INSUFFICIENT INFORMATION

- Notes:**
- (1) Temperature, concentrations, impurities, and other chemicals present can affect the chemical resistance of an elastomer. It is not possible to test in all chemicals and therefore some chemical resistance indicators are based on the manufacturer's best estimates known about various classes and the composition of the elastomer. Therefore, manufacturers do not certify results from a performance standpoint but state they should be used only as indicators of chemical resistance. APG assumes no responsibility whatsoever.
 - (2) The information contained in these tables was derived from several sources and is to be used as a general guide only. Compounds suitable for any specific application rests solely by the end user. APG assumes no responsibility whatsoever.

Compound Selection for Fluids and Chemicals (Continued)

	NITRILE	CHLORO-PRENE	ETHYLENE PROPYLENE (EPR)	FLUORO-ELASTOMER	SILICONE	STYRENE BUTADIENE (SBR)	FLUORO-SILICONE	BUTYL	AFLAS®	URETHANE
Propyl Nitrate	D	D	B	D	D	D	D	B	E	E
Propylene	D	D	D	A	D	D	B	D	A	D
Propylene Oxide	D	D	B	D	D	D	D	B	D	D
Pydraul, 10E, 29 ELT	D	D	A	A	D	D	D	A	A	D
Pydraul, 30E, 50E, 65E, 90E	D	D	A	A	A	D	A	A	A	D
Pydraul, 115E	D	D	A	A	D	D	C	A	A	D
Pydraul, 230E, 312C, 540C	D	D	D	A	D	D	D	D	A	D
Pyranol, Transformer Oil	A	B	D	A	D	D	A	D	A	B
Pyridine	D	D	B	D	D	D	D	B	E	E
Pyrolygenous Acid	D	B	B	D	E	D	D	B	E	D
Pyrrole	D	D	C	D	B	C	C	D	E	E
Radiation	C	B	B	D	C	C	D	D	A	D
Rapeseed Oil	B	B	A	A	D	D	A	A	A	B
Red Oil (MIL-H-5606)	A	B	D	A	D	D	A	D	A	A
RJ-1 (MIL-F-25558 B)	A	B	D	A	D	D	A	D	A	A
RP-1 (MIL-F-25576 C)	A	B	D	A	D	D	A	D	A	A
Sal Ammoniac	A	A	A	A	B	A	A	A	A	A
Salicylic Acid	B	A	A	A	E	B	A	A	A	E
Salt Water	A	B	A	A	A	A	A	A	A	B
Sewage	A	B	B	A	B	B	A	B	A	D
Silicate Esters	B	A	D	A	D	D	A	D	A	A
Silicone Greases	A	A	A	A	C	A	A	A	A	A
Silicone Oils	A	A	A	A	C	A	A	A	A	A
Silver Nitrate	B	A	A	A	A	A	A	A	A	A
Skydrol 500	D	D	A	D	C	D	C	B	B	D
Skydrol 7000	D	D	A	B	C	D	C	A	A	E
Soap Solutions	A	B	A	A	A	A	A	A	A	D
Soda Ash	A	A	A	A	A	A	A	A	A	E
Sodium Acetate (aq)	B	B	A	D	D	D	D	A	D	C
Sodium Bicarbonate (aq) (Baking Soda)	A	A	A	A	A	A	A	A	A	E
Sodium Bisulfite (aq)	A	A	A	A	A	B	A	A	A	E
Sodium Borate (aq)	A	A	A	A	A	A	A	A	A	E
Sodium Chloride (aq)	A	A	A	A	A	A	A	A	A	A
Sodium Cyanide (aq)	A	A	A	A	A	A	A	A	A	E
Sodium Hydroxide (aq)	B	A	A	B	B	A	B	A	A	B
Sodium Hypochlorite (aq) (Chlorox)	B	A	B	A	B	D	B	B	A	D
Sodium Metaphosphate(aq)	A	B	A	A	E	A	A	A	A	E
Sodium Nitrate (aq)	B	B	A	E	D	A	E	A	A	E
Sodium Perborate (aq)	B	B	A	A	B	B	A	A	A	E
Sodium Peroxide (aq)	B	B	A	A	D	B	A	A	A	D
Sodium Phosphate (aq)	A	B	A	A	D	A	E	A	A	A
Sodium Silicate (aq)	A	A	A	A	E	A	E	A	A	E
Sodium Sulfate (aq)	A	A	A	A	A	B	A	A	A	A
Sodium Thiosulfate (aq)	B	A	A	A	A	B	A	A	A	A
Soybean Oil	A	B	C	A	A	D	A	C	A	E
Stannic Chloride (aq)	A	B	A	A	B	A	A	A	A	E
Stannous Chloride (aq)	A	A	A	A	B	A	A	A	A	E
Steam, under 300°F	D	C	A	D	C	D	D	B	A	D
Steam, over 300°F	D	D	C	D	D	D	D	D	A	D
Stearic Acid	B	B	B	E	B	B	E	B	A	E
Stoddard Solvent	A	B	D	A	D	D	A	D	B	A
Styrene	D	D	D	B	D	D	C	D	E	E
Sucrose Solution	A	B	A	A	A	A	A	A	A	D
Sulfite Liquors	B	B	B	A	D	B	B	B	E	E

A. SATISFACTORY B. FAIR C. SEVERE EFFECT – EXCEPT FOR SOME STATIC APPLICATIONS D. UNSATISFACTORY E. INSUFFICIENT INFORMATION

- Notes:**
- (1) Temperature, concentrations, impurities, and other chemicals present can effect the chemical resistance of an elastomer. It is not possible to test in all chemicals and therefore some chemical resistance indicators are based on the manufacturer's best estimates known about various classes and the composition of the elastomer. Therefore, manufacturers do not certify results from a performance standpoint but state they should be used only as indicators of chemical resistance. APG assumes no responsibility whatsoever.
 - (2) The information contained in these tables was derived from several sources and is to be used as a general guide only. Compounds suitable for any specific application rests solely by the end user. APG assumes no responsibility whatsoever.

Compound Selection for Fluids and Chemicals (Continued)

	NITRILE	CHLORO-PRENE	ETHYLENE PROPYLENE (EPR)	FLUORO-ELASTOMER	SILICONE	STYRENE BUTADIENE (SBR)	FLUORO-SILICONE	BUTYL	AFLAS®	URETHANE
Sulfur	D	A	A	A	C	D	A	A	A	E
Sulfur Chloride (aq)	C	C	D	A	C	D	A	D	A	E
Sulfur Dioxide (Dry)	D	D	A	A	B	B	B	B	E	E
Sulfur Dioxide (Wet)	D	B	A	A	B	D	B	A	E	E
Sulfur Dioxide (liquified under pressure)	D	D	A	A	B	D	B	B	E	E
Sulfur Hexafluoride	B	A	A	A	B	D	B	A	C	E
Sulfur Trioxide	D	D	B	A	B	B	B	B	A	E
Sulfuric Acid (dilute)	C	B	B	A	D	C	C	B	A	D
Sulfuric Acid (conc.)	D	D	C	B	D	D	D	D	A	D
Sulfuric Acid (20% Oleum)	D	D	D	A	D	D	D	D	E	D
Sulfurous Acid	B	B	B	A	D	B	E	B	A	C
Tannic Acid	A	A	A	A	B	B	E	A	A	E
Tar, Bituminous	B	C	C	A	B	D	A	C	A	E
Tartaric Acid	A	B	B	A	A	D	A	B	A	A
Terpineol	B	D	C	A	E	D	A	C	A	B
Tertiary Butyl Alcohol	B	B	B	A	B	B	B	B	A	D
Tertiary Butyl Catechol	D	B	B	A	E	B	A	B	A	D
Tertiary Butyl Mercaptan	D	D	D	A	D	D	E	D	E	D
Tetrabromoethane	D	D	D	A	D	D	B	D	E	E
Tetrabromomethane	D	D	D	A	D	D	B	D	E	E
Tetrabutyl Titanate	B	B	A	A	E	B	A	B	A	E
Tetrachloroethylene	D	D	D	A	D	D	B	D	E	D
Tetraethyl Lead	B	B	D	A	E	D	B	D	E	E
Tetrahydrofuran	D	D	B	D	D	D	D	C	D	C
Tetralin	D	D	D	A	D	D	A	D	E	E
Thionyl Chloride	D	D	C	B	E	D	E	D	E	E
Titanium Tetrachloride	B	D	D	A	D	D	B	D	E	D
Toluene	D	D	D	A	D	D	B	D	C	D
Toluene Diisocyanate	D	D	B	D	D	D	D	B	D	E
Transformer Oil	A	B	D	A	B	D	A	D	A	A
Transmission Fluid Type A	A	B	D	A	B	D	A	D	A	A
Triacetin	B	B	A	D	E	B	D	A	E	D
Triaryl Phosphate	D	D	A	A	C	D	B	A	A	D
Tributoxy Ethyl Phosphate	D	D	A	A	E	B	B	A	A	D
Tributyl Mercaptan	D	D	D	A	D	D	C	D	E	E
Tributyl Phosphate	D	D	B	D	D	D	D	B	E	D
Trichloroacetic Acid	B	D	B	C	E	B	D	B	C	D
Trichloroethane	D	D	D	A	D	D	B	D	E	D
Trichloroethylene	D	D	D	A	D	D	B	D	E	D
Tricresyl Phosphate	D	C	A	A	C	A	B	A	A	D
Triethanol Amine	B	A	A	D	E	B	D	B	A	D
Triethyl Aluminum	D	D	C	B	E	D	E	C	E	E
Triethyl Borane	D	D	C	A	E	D	E	C	E	E
Trinitrotoluene	D	B	D	B	E	D	B	D	E	E
Trioctyl Phosphate	D	D	A	B	C	D	B	A	A	D
Tung Oil (China Wood Oil)	A	B	C	A	D	D	B	C	A	C
Turbine Oil	B	D	D	A	D	D	B	D	A	A
Turpentine	A	D	D	A	D	D	B	D	A	D
Unsymmetrical Dimethyl Hydrazine (UDMH)	B	B	A	D	D	A	D	A	E	E
Varnish	B	D	D	A	D	D	B	D	E	C
Vegetable Oils	A	C	C	A	B	D	A	C	A	E
Versilube F-50	A	A	A	A	C	A	A	A	A	A
Vinegar	B	B	A	A	A	B	C	A	A	D

A. SATISFACTORY B. FAIR C. SEVERE EFFECT – EXCEPT FOR SOME STATIC APPLICATIONS D. UNSATISFACTORY E. INSUFFICIENT INFORMATION

- Notes:**
- (1) Temperature, concentrations, impurities, and other chemicals present can effect the chemical resistance of an elastomer. It is not possible to test in all chemicals and therefore some chemical resistance indicators are based on the manufacturer's best estimates known about various classes and the composition of the elastomer. Therefore, manufacturers do not certify results from a performance standpoint but state they should be used only as indicators of chemical resistance. APG assumes no responsibility whatsoever.
 - (2) The information contained in these tables was derived from several sources and is to be used as a general guide only. Compounds suitable for any specific application rests solely by the end user. APG assumes no responsibility whatsoever.

Compound Selection for Fluids and Chemicals (Continued)

	NITRILE	CHLORO-PRENE	ETHYLENE PROPYLENE (EPR)	FLUORO-ELASTOMER	SILICONE	STYRENE BUTADIENE (SBR)	FLUORO-SILICONE	BUTYL	AFLAS®	URETHANE
Vinyl Chloride	D	D	D	A	E	D	E	D	E	E
Wagner 21B Brake Fluid	C	B	A	D	C	A	D	B	A	F
Water	A	A	A	A	A	A	A	A	A	D
Whiskey, Wines	A	A	A	A	A	A	A	A	A	D
White Pine Oil	B	D	D	A	D	D	A	D	A	E
White Oil	A	B	D	A	D	D	A	D	A	A
Wood Oil	A	B	D	A	D	D	B	D	A	C
Xylene	D	D	D	A	D	D	A	D	B	D
Xylidine (Di-methyl Aniline)	C	C	B	D	D	C	D	C	E	E
Zeolites	A	A	A	A	E	A	A	A	A	E
Zinc Acetate (aq)	B	B	A	D	D	D	D	A	D	D
Zinc Chloride (aq)	A	A	A	A	A	A	A	A	A	E
Zinc Sulfate (aq)	A	A	A	A	A	B	A	A	A	E

A. SATISFACTORY B. FAIR C. SEVERE EFFECT – EXCEPT FOR SOME STATIC APPLICATIONS D. UNSATISFACTORY E. INSUFFICIENT INFORMATION

- Notes:**
- (1) Temperature, concentrations, impurities, and other chemicals present can effect the chemical resistance of an elastomer. It is not possible to test in all chemicals and therefore some chemical resistance indicators are based on the manufacturer's best estimates known about various classes and the composition of the elastomer. Therefore, manufacturers do not certify results from a performance standpoint but state they should be used only as indicators of chemical resistance. APG assumes no responsibility whatsoever.
 - (2) The information contained in these tables was derived from several sources and is to be used as a general guide only. Compounds suitable for any specific application rests solely by the end user. APG assumes no responsibility whatsoever.

Age Controls

Because of short shelf life of very early Neoprene and/or Neoprene/Nitrile blends, the Government imposed an Age Control Program known as ANA Bulletin 438C on Military O-Rings. Its step-by-step schedule allowed the manufacturer (or his agent) four quarters beyond the part curing date to deliver it to the component builder. They had two more quarters to install the oldest part in their equipment. These components then had a maximum of 12 quarters (3 years) until delivery of the aircraft to the Government. This applied only to Nitrile Compounds. Those of other polymers were not covered.

As a result of long-term evaluations of stored O-Rings by a number of Air Force, Army, and Navy laboratories and a long-term study by the O-Ring industries laboratories and investigations of long stored and long lost crashed aircraft hydraulic systems, it is concluded that modern Nitrile Compounds are safe to use 5 to 10 years (varying on who makes the conclusion) after the date of the manufacture. Further information may be found in Air Force Technical Report AFML-TR-67-235, if desired.

MIL-STD-1523A dated Feb. 1, 1984 replaced MIL-STD-1523 and now allows the manufacturer of the O-Ring or his agent a full 40 quarters (10 years) to deliver his product to the procuring activity or contracting officer. MIL-STD-1523A does not control the age beyond this point for O-Rings although it is still very restrictive for hose which is also covered. Military Material specifications covered by MIL-STD-1523 include: MIL-P-5315, MIL-P-5510, MIL-P-5516, MIL-S-6855CI.I, MIL-R-7362, MIL-P-25732, MIL-P-83461.

Age Resistance of Elastomers

Although when properly stored, elastomers have been known to shelf age for very long periods of time, the following chart indicates the generally accepted age resistance for various elastomers (from MIL-HDBK-695):

Material	Number of Years
Aflas	Unlimited
Butyl	Unlimited
Chloroprene	15
Epichlorohydrin	N/A
Ethylene Propylene	Unlimited
Fluorocarbon (Viton)	Unlimited
Fluorosilicone	Unlimited
Highly Saturated Nitrile	15
Hypalon	15
Neoprene	15
Nitrile	15
Polyacrylate	15
Polysulfide	Unlimited
PTFE (TEFLON®)	Unlimited
Silicone	Unlimited
SBR	3
Urethane (Polyester)	5

Suggested proper storage conditions

O-Rings should be stored in clean, dry, containers away from ozone, contaminants, sunlight, radiation at a temperature not to exceed 120°F.

Fastener Seals and Thread Seals

Fastener Seals

Fastener seals are one-piece, molded-in-place seals with the rubber sealing element mechanically locked to the metal retainer. They are designed to seal beneath the head of the fastener for both internal and external pressure systems.

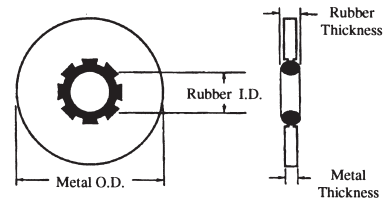

The principle of controlled confinement is utilized in the design of fastener seals. As the fastener is tightened, the rubber seal is compressed, forcing the sealing surfaces securely around the fastener shank - but without squeezing the rubber beyond its elastic limit, or destroying its inherent memory. With fastener seals, there is full metal-to-metal contact at the joining surfaces.

Faster seals provide self-centering for the seal, vacuum sealing, high-pressure sealing, long service, easy installation, moderate torquing, no retorquing, and quick visual inspection.

The 600-Series fastener seals at APG are 70 durometer nitrile and commercial CAD plated steel, or 70 durometer silicone and commercial CAD plated steel. They are available in standard sizes for bolts and screws as listed below.

SIZE DASH NUMBER	PART NUMBER		THREAD MAJOR DIAMETER	RUBBER I.D.	METAL O.D.	METAL THICKNESS	RUBBER THICKNESS
	NITRILE	SILICONE					
-6	AFS600-0101-6	*	.138	.130	.385	.040	.050
-8	*	*	.164	.156	.385	.040	.050
-10	AFS600-0101-10	*	.190	.180	.443	.050	.072
-10 O.S.	AFS600-0101-10OS	*	.190	.186	.468	.050	.072
-¼	AFS600-0101-¼	AFS600-6230-¼	.250	.240	.505	.050	.072
-¼ O.S.	AFS600-0101-¼ O.S.	*	.250	.245	.531	.050	.072
-⅜	AFS600-0101-⅜	*	.312	.301	.603	.050	.072
-⅜	AFS600-0101-⅜	AFS600-6230-⅜	.375	.364	.666	.050	.072
-⅞	AFS600-0101-⅞	*	.438	.427	.760	.050	.072
-½	AFS600-0101-½	*	.500	.490	.880	.050	.072
-⅝	AFS600-0101-⅝	*	.562	.552	1.067	.050	.072
-⅝	AFS600-0101-⅝	*	.625	.615	1.193	.050	.072
-¾	AFS600-0101-¾	*	.750	.740	1.322	.064	.096
-⅞	AFS600-0101-⅞	*	.875	.864	1.510	.064	.096
-1	AFS600-0101-1	*	1.000	.988	1.760	.064	.096

* Not currently an APG stock item. Call for availability.

Thread Seals

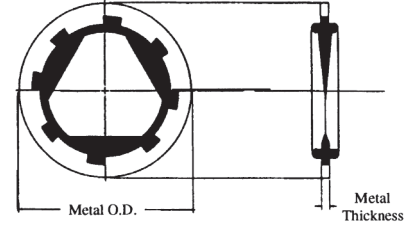

Like fastener seals, thread seals are one-piece molded-in-place seals with the rubber sealing element mechanically locked to the metal retainer. They are designed to seal beneath the nut of the fastener and seal directly against the threads of the fastener. This design allows thread seals to block the spiral passage created by the threads that might permit the fluid to wind its way through the helix. When the thread seal is compressed between the nut and the mating surface, the squeeze on the crown causes the inside of the seal to bulge inward and hug the crest of the thread. This blocks the axial outside leak path. The thread seal also has three wedge-shaped protrusions inside the cylinder hole. Since all standard screw threads have only a single V-shaped spiral channel, one of these wedges will always be in a position to block the flow of fluid through this channel.

Thread seals are self-centering and non-directional. Their low cost can provide considerable savings because they make possible the use of low cost standard fasteners and full threaded fittings. No special tools or skills are needed for assembly.

The 7500-Series thread seals at APG are 70 durometer nitrile and commercial CAD plated steel, or 70 durometer fluoroelastomer and commercial CAD plated steel. They are available in standard sizes for bolts and screws as listed below.

SIZE DASH NUMBER	PART NUMBER		METAL O.D.	METAL THICKNESS
	NITRILE	FLUROELASTOMER		
-6	*	*	.406	.051
-8	*	*	.406	.051
-10	ATS7500-10	*	.469	.051
-¼	ATS7500-¼	*	.562	.051
-⅙	ATS7500-⅙	*	.687	.064
-⅜	ATS7500-⅜	ATS7500-⅜VT	.750	.064
-⅚	*	*	.906	.078
-½	ATS7500-½	*	1.000	.078
-⅝	*	*	1.094	.094
-⅞	ATS7500-⅞	ATS7500-⅞VT	1.187	.094
-¾	ATS7500-¾	*	1.375	.109
-⅞	ATS7500-⅞	*	1.562	.109
-1	ATS7500-1	*	1.750	.120

* Not currently an APG stock item. Call for availability.

Glossary

DEVELOPED BY THE O-RING DIVISION OF THE RUBBER MANUFACTURING ASSOCIATION, INC.

ABRASION

Progressive wearing away of material.

ABRASION RESISTANCE

The ability of a rubber Compound to resist mechanical wear.

ACCELERATED LIFE TEST

Any set of conditions designed to reproduce in a short time the deteriorating effect obtained under normal service conditions.

ACCELERATED SERVICE TEST

A service or bench test in which some service condition, such as speed, or temperature, or continuity of operation, is exaggerated in order to obtain a result in shorter time.

ACID RESISTANT

Withstands the action of acids.

ADHERE

To cling or stick together.

ADHESION

Susceptibility of rubber to stick to a contact surface.

AFTER CURE

Continuation of vulcanization after the desired cure is effected and the heat source removed.

AGING

To undergo changes in physical properties with age or lapse of time

AGING, AIR OVEN

A means of accelerating the change in physical properties of rubber Compounds by exposing them to the action of air at an elevated temperature.

AGING, AIR PRESSURE HEAT

A means of accelerating the change in physical properties of rubber Compounds by exposing them to the action of air under pressure at an elevated temperature.

AGING, OXYGEN BOMB

A means of accelerating the change in physical properties of rubber Compounds by exposing them to the action of oxygen at an elevated temperature and pressure.

AIR BOMB

Similar to an oxygen bomb but used with air. Used for accelerated aging test.

AIR CHECKS

Surface markings or depressions due to trapping air between the materials being cured and the mold or press surface.

AIR CURING

The vulcanization of a rubber product in air as distinguished from vulcanizing in a press or steam vulcanizer.

AMBIENT TEMPERATURE

The environment temperature surrounding the object under consideration.

ANILINE NO. OF OIL

Temperature at which a given amount of aniline reacts with a particular oil. The aniline point generally affects the swell.

ATMOSPHERIC CRACKING

Cracks produced in surface of rubber articles by exposure to atmospheric conditions.

AVERAGE MODULUS

Total change of stress divided by total change of strain, i.e., the average slope of the stress-strain curve. Employed when modulus varies from point to point.

BACK RIND

A burn-back into the part at a mold line separation caused by too soft a rubber stock, excessive acceleration, or too low a plasticity.

BACK-UP RING

Washer-like device installed next to O-Ring to prevent extrusion.

BENCH TEST

A modified service test in which the service conditions are approximated, but the equipment is conventional laboratory equipment and not necessarily identical with that in which the product will be employed.

BENDING MODULUS

Force required to induce bending around a given radius, and hence a measure of stiffness.

BLEEDING

Migration to the surface of plasticizers, waxes, or similar materials to form a film or beads.

BLEMISH

A mark, deformity, or injury which impairs the appearance.

BLISTERS

A raised spot on the surface or a separation between layers usually forming a void or air-filled space in the vulcanized article.

BLOOM

A discoloration or change in appearance of the surface of a rubber product caused by the migration of a liquid or solid to the surface. Examples: sulfur bloom, wax bloom. Not to be confused with dust on the surface from external sources.

BREAK

A separation or discontinuity in any part of an article.

BREAKOUT

Force to inaugurate sliding. Expressed in same terms as friction. An excessive breakout value is taken as an indication of the development of adhesion.

BRITTLENESS

Tendency to crack when subjected to deformation.

BUNA N

A general term for the copolymers of butadiene and acrylonitrile. Typical commercial polymers are Hycar and Paracril.

BUNA S

A general term for the copolymers of butadiene and styrene.

BUTT JOINT

Joining two ends of material whereby the junction is perpendicular to the ID of an O-Ring.

BUTYL

A synthetic rubber of the polybutene type exhibiting very low permeability to gases.

COEFFICIENT OF THERMAL EXPANSION

Average expansion per degree over a stated temperature range, expressed in a fraction of initial dimension. May be linear or volumetric.

COLD FLEXIBILITY

Flexibility following exposure to a predetermined low temperature for a predetermined time.

COLD FLOW

Continued deformation under stress.

COLD RESISTANT

Withstands the effect of cold or low temperatures without loss of serviceability.

COMMERCIALY SMOOTH

Degree of smoothness of the surface of an article which is acceptable for use.

COMPOUND

A term applied to either vulcanized or unvulcanized mixtures of elastomers and other ingredients necessary to make a useful rubber-like material.

COMPRESSION MODULUS

The ratio of the compressive stress to the resulting compressive strain (the latter expressed as a fraction of the original height or thickness in the direction of the force). Compression Modulus may be either static or dynamic.

COMPRESSION SET

The decrease in thickness of a rubber specimen which has been deformed under specific conditions of load, time and temperature.

CONDUCTIVE

A rubber having qualities of conducting or transmitting heat or electricity. Most generally applied to rubber products used to conduct static electricity.

CONDUCTIVITY

Quality or power of conducting or transmitting heat or electricity.

COPOLYMER

A polymer consisting of two different monomers chemically combined.

CORROSION (PACKING)

Corrosion of rigid member (usually metal) where it contacts packing. The actual corroding agent is fluid medium trapped in the interface.

CORROSIVE (PACKING)

A property of packing whereby it is assumed, often incorrectly, to promote corrosion of the rigid member by the trapped fluid.

CRACKING

A sharp break or fissure in the surface. Generally due to excessive strain.

CROSS-SECTION

An O-Ring as viewed if cut at right angles to the axis showing internal structure.

CURING DATE

O-Ring molding date.

CURING TEMPERATURE

The temperature at which the rubber product is vulcanized.

CYLINDER

Chamber in which piston, plunger, ram, rod, or shaft is driven by or against the pressure medium.

DUROMETER

An instrument for measuring the hardness of rubber. Measures the resistance to the penetration of an indenter point into the surface of rubber.

DYNAMIC

O-Ring application in which the O-Ring is subject to movement or moving parts.

DYNAMIC PACKING

A packing employed in a joint whose members are in relative motion.

DYNAMIC SEAL

A seal required to prevent leakage past parts which are in relative motion.

ELASTICITY

The property of an article which tends to return to its original shape after deformation.

ELASTIC LIMIT

The greatest stress which a material is capable of developing without a permanent deformation remaining upon complete release of the stress. In rubber, the elastic limit as above defined is very low and sometimes practically non-existent. Usually this term is replaced by various load limits for specific cases in which the resulting permanent deformations are not zero but are negligible.

ELASTOMER

A general term for elastic, rubber-like substances.

ELONGATION

Increase in length expressed numerically as a fraction or percentage of initial length.

EXTRUSION

Distortion, under pressure, of portion of seal into clearance between mating metal parts.

FILLER

Chemically inert, finely divided material added to the polymer to aid in processing and improving properties of abrasion resistance and strength - gives it varying degrees of hardness.

FLASH

Excess rubber left around rubber part after molding due to space between mating mold surfaces; removed by trimming.

FLEX CRACKING

A surface cracking induced by repeated bending or flexing.

FLEX LIFE

The relative ability of a rubber article to withstand dynamic bending stresses.

FLOCK

Fibers added to rubber Compounds.

FLOW CRACKS

Surface imperfections due to improper flow and failure of stock to knit or blend with itself during the molding operation.

FRICTION

Resistance to motion due to the contact of surfaces.

FRICTION, BREAKOUT

Initial or starting friction developed when employed as a dynamic seal.

FRICTION, RUNNING

Constant friction developed during operation of a dynamic O-Ring

FUEL, AROMATIC

Fuel which contains benzene or aromatic hydrocarbons.

FUEL, NON-AROMATIC

Fuel which is composed of straight chain hydrocarbons.

GLAND

Seal assembly, including O-Ring, groove which holds the O-Ring, and contacting surfaces.

HARDNESS

Property or extent of being hard. Measured by extent of failure of the indenter point or any one of a number of standard hardness testing instruments to penetrate the product.

HARDNESS SHORE A

Durometer reading in degrees of the hardness of the rubber. (Shore A hardness of 35 is soft; 90 is hard.)

HOMOGENEOUS

General - a material of uniform composition throughout.

HYCAR P.A.

Commercial name for polymer or acrylic acid ester.

HYPALON

Commercial name for chlorosulphonated derivative of polyethylene.

IDENTIFICATION

Colored dots or stripes on O-Rings for identification purposes.

IMMEDIATE SET

The deformation found by measurement immediately after removal of the load causing the deformation.

IMMERSION

Placing an article into a fluid, generally so it is completely covered.

IMPACT

The single instantaneous stroke or contact of a moving body with another either moving or at rest, such as a large lump of material dropping on a conveyor belt.

LIFE TEST

A laboratory procedure used to determine the amount and duration of resistance of a rubber article to a specific set of destructive forces or conditions.

LINEAR EXPANSION

Expansion in any one linear dimension or the average of all linear dimensions.

LOGY

Sluggish, low snap or recovery of a material.

LOW TEMPERATURE FLEXIBILITY

The ability of a rubber product to be flexed, bent or bowed at low temperatures.

LOW TEMPERATURE FLEXING

Act or instance of repeated bending or bowing a rubber product under conditions of low temperature.

MIRROR FINISH

A bright, polished surface.

MISALIGNMENT

Departure from alignment.

MISMATCH

Poor matching or meeting in splice.

MODULUS

Tensile stress at a specified elongation.

MODULUS OF ELASTICITY

One of the several measurements of stiffness or resistance to deformation, but often incorrectly used to indicate specifically static tension modulus.

MOLD CAVITY

Hollow space or cavity in the mold which is used to impart the desired form to the product being molded.

MOLD FINISH

The uninterrupted surface produced by intimate contact of rubber with the surface of the mold at vulcanization.

MOLD MARKS

Indentations or ridges embossed into the skin of the molded product by irregularities in the mold cavity surface.

MOLD REGISTER

Means used to align the parts of a mold.

MOONEY SCORCH

The measurement of the rate at which a rubber Compound will precure or set up by means of the Mooney Viscometer.

MOONEY VISCOSITY

The measurement of the plasticity or viscosity of an uncompounded or compounded unvulcanized rubber and rubber-like materials by means of the Mooney Shearing Disk Viscometer.

NICK

A small notch, slit, or cut.

NOMINAL LENGTH

The desired length from which tolerances are set.

NON-BLOOMING

The absence of bloom.

OIL RESISTANT

Ability of a vulcanized rubber to resist the swelling and deteriorating effects of various type oils.

OIL SWELL

The change in volume of a rubber article due to absorption of oil.

O-RING

An elastomeric seal of homogeneous composition molded in one piece to the configuration of a torus with circular cross-section (doughnut). The O-Ring is used as a dynamic or static seal usually installed in a machined groove.

OPTIMUM CURE

State of vulcanization at which maximum desired property is attained.

OVER CURE

A degree of cure greater than the optimum.

OXIDATION

The reaction of oxygen on a rubber product, usually detected by a change in the appearance or feel of the surface or by a change in physical properties.

OXYGEN BOMB

A chamber capable of holding oxygen at an elevated pressure which can be heated to an elevated temperature. Used for an accelerated aging test.

OZONE RESISTANT

Withstands the deteriorating effects of ozone (generally cracking).

PACKING

A flexible device used to retain fluids under pressure or seal out foreign matter.

PACKING GROOVE

A groove carved in a flange, or in one member of a concentric joint, to accommodate a packing.

PERMANENT SET

Permanent set is the deformation remaining after a specimen has been stressed in tension a prescribed amount for a definite period and released for a definite period.

PERMEABILITY

Property of rubber or other materials which permits passage of gas through the molecular structure of the material.

PIT OR POCK MARK

A circular depression, usually small.

POLYMER

A material formed by the joining together of many (poly) individual units (mer) of a monomer.

POROSITY

Quality of state of being porous due to presence of globular structural voids.

REGISTER, OFF OR MISMATCH

Nonconformity of finished article with design dimensions due to mold misalignment during cure.

RELATIVE HUMIDITY

The ratio of the quantity of water vapor actually present in the atmosphere to the greatest amount possible at the given temperature.

RESILIENCE

Capable of returning to original size and shape after deformation.

RMS

Root mean square - The measure of surface roughness, obtained as the square root of the sum of the squares of micro-inch deviation from true flat.

ROUGH TRIM

Removal of superfluous parts by pulling or picking. Usually a small portion of the flash or sprue remains attached to the product.

RUBBER, NATURAL

Raw or crude rubber obtained from vegetable sources, basically the Unsaturated polymer of isoprene.

RUBBER, NITRILE (BUNA N)

Copolymer of butadiene and acrylonitrile; known commercially as Butaprene, Chemigum, Hycar OR, Perbunan and Paracril.

RUBBER, SILICONE

Semi-organic elastomer, containing silicone.

RUBBER, SYNTHETIC

Manufactured elastomers.

RUNOUT (SHAFT)

Same as Gyration. When expressed in inches alone or accompanied by abbreviation "TIR" (total indicator reading), it refers to twice the radial distance between shaft axis and axis of rotation.

SEAL

Any device used to prevent the passage of a gas or liquid.

SERVICE

Operating conditions to be met.

SHAFT

Rotating member within cylinder; not in contact with walls.

SHRINKAGE

Decreased volume of unit caused by air drying after immersion in fluid.

SIZE, ACTUAL

Actual dimensions of the O-Ring, including tolerance limits.

SIZE, NOMINAL

Approximate size of O-Ring in fractional dimensions.

SPECIFIC GRAVITY

The ratio of the weight of a given substance to the weight of an equal volume of water at a specified temperature.

SPRUE MARKS

Marks left on the surface of a rubber part, usually elevated, after removal of the sprue.

SQUEEZE

Cross-section diametral compression of O-Ring between bottom surface of the groove and surface of other mating metal part in the gland assembly.

STATIC

Stationary application such as a gasket.

STATIC SEAL

Seal designed to work between parts having no relative motion.

STRESS

Force per unit of original cross-sectional area required to stretch a specimen to a stated elongation.

SUN CHECKING

Surface cracks, checks, or crazing caused by exposure to direct or indirect sunlight.

SWELL

Increased volume of unit caused by immersion in fluid.

TEMPERATURE RANGE

Lowest temperature at which rubber remains flexible and highest temperature at which it will function.

TENSILE STRENGTH.

Force in pounds per square inch required to cause the rupture of a specimen of a rubber material.

TERPOLYMER

A polymer consisting of three different monomers chemically combined.

THIOKOL

A synthetic rubber of the polysulfide type.

THERMAL EXPANSION

Expansion caused by increase in temperature. May be linear and volumetric.

TORQUE

The turning power of a shaft.

TRIM

The process involving removal of mold flash.

TRIM CUT

Damage to mold skin or finish by too close trimming.

UNDER-CURE

Degree of cure less than optimum. May be evidenced by tackiness, loginess or inferior physical properties.

VOIDS

The absence of material or an area devoid of materials where not intended.

VISCOSITY

A manifestation of internal friction opposed to mobility. The property of fluids and plastic solids by which they resist an instantaneous change of shape, i.e., resistance to flow.

VOLUME CHANGE

Change in volume of a specimen which has been immersed in a designated fluid under specified condition of time and temperature. Expressed as a percentage of the original volume.

VOLUME SWELL

Increase in physical size caused by the swelling action of a liquid.

VULCANIZATION

A thermo-setting involving the use of heat and pressure and which results in greatly increased strength and elasticity of rubber-like materials.

WIDTH

Radial dimension. For packing rings or sets the term "packing space" is preferred.

WIPER RING

A ring employed to remove excess fluid, mud, etc., from a reciprocating member before it reaches the packing.

Industrial Hose Couplings

- Accessories
 - Cam & Groove Gaskets
 - Fuel Gaskets
 - Hammer Union Seals
 - Handle, Ring, Pin
 - Pipe Coupling Gaskets
 - Safety Cables
 - Sanitary Gaskets
- Air Hose - Coupled
- Cam and Groove
 - EVER-TITE®
 - Tough-TITE®
 - U-TITE®
- 90
 - Heavy Duty Ductile Iron
 - Increases / Reducers
 - Spool Couplers & Adapters
 - Swivel
- Clamps
 - Band-IT
 - Ideal
 - APG Worm Gear
 - Band-IT Tools
- Combination Nipples/ Menders
- Crimp Sleeves & Ferrules
- Fire Fittings
 - NH Thread Couplings
 - Hydrant Adapters
 - Hex Nipples
- Ground Joint
- Hose Barb Fittings
- Hose Shank
- Hydraulic Hose
- Pin Lugs / Suction Couplings
- Protective Sleeving - Bentley - Harris
- Quick Disconnect
- Railroad Tank Car Adapters
- Sandblast
- Strainers
- Transportation
 - Drop Couplers
 - Elbow
 - Couplers & Adapters with Relief Nipple
 - Tight Fill
 - Vapor Recovery
 - Flange Couplings and Gaskets
- Universal / Crowfoot
- Valves
 - Check
 - Foot
 - Gate

Pressure Gauges

- Dry - Black Steel w/Brass
 - Connections
- Liquid Filled
 - Stainless Steel Case w/ Brass
 - Connections
 - All Stainless Steel

O-Rings

- Aflas® 80 Durometer
- Chloroprene 70 Durometer
- E.P.R. 70 Durometer
 - Standard & Metric
- E.P.R. Peroxide Cured
 - 80 Durometer
- Fluoroelastomer - Black
 - Standard 75 & 90 Durometer
 - Metric 75 & 90 Durometer
- Fluoroelastomer - Brown
 - Standard 75 & 90 Durometer
 - Metric 75 Durometer
- Fluorosilicone 70 Durometer
- Highly Saturated Nitrile
 - Green 70 Durometer
 - Standard & Metric
 - Black 80 & 90 Durometer
 - Blue TFE Coated 70 Durometer
- Kalrez® 4079
- Nitrile - Black
 - Standard 50, 70, 90 Durometer
 - Metric 70 & 90
 - Large Cross Section 70 Durometer
- Nitrile - Black - Peroxide Cured
 - 90 Durometer
- PTFE
- Silicone 70 Durometer
 - Standard & Metric
- Square Cut Rings
 - Nitrile 70 Durometer
- Teflon® Encapsulated
 - Viton® Core
 - Silicone Core
- Urethane 70 & 90 Durometer
- 4 Lobe Q-Rings
 - Nitrile 70 Durometer
 - Fluorelastomer 75 Durometer
- Minesota Quad-Rings®
 - Available at APG Ohio
 - 366Y Nitrile 70 Durometer
 - 514AD FKM 70 Durometer
- Non-Standard Sizes
 - Vulcanized
- Kits
 - Standard
 - Metric
 - Splicing
 - Specialty
- O-Ring Accessories
 - Measuring Devices
 - Cones
 - Tapes
 - Sizing
 - Gauges
 - Compound Identifiers
- Lubricants
- Picks

FDA O-Rings

- E.P.R. Peroxide Cured NSF FDA
 - White 70 Durometer
- Fluorelastomer FDA - White 60 Durometer
- Nitrile FDA- Black 70 Durometer
- Nitrile FDA- White 70 Durometer
- Nitrile Metal Detectable 70 Durometer
- Silicone FDA - 70 Durometer

Back-Up Rings

- PTFE
 - Solid
 - Split
 - Spiral
- Contoured Back-Up Rings
 - Nitrile 90 Durometer
 - Fluoroelastomer 90 Durometer
- Leather

O-Ring Cord

- Aflas® 75 Durometer
- E.P.R. 70 Durometer
- Fluoroelastomer - standard & metric
 - Inch 75 & 90 Durometer
 - Metric 75 Durometer
 - Square 75 Durometer
- Fluoroelastomer - Brown
 - 75 Durometer
- Neoprene 70 Durometer
- Neoprene Sponge - Closed Cell
- Nitrile
 - Inch - 50, 70, & 90 Durometer
 - Metric - 70 & 90 Durometer
 - Square - 70 Durometer
- Silicone 70 Durometer
 - Inch 70 Durometer
 - Metric 70 Durometer
- 4-Lobe Q-Ring
 - Nitrile 70 Durometer
 - Fluoroelastomer 75

Extrusions

- EPDM
- Fluoroelastomer
- Neoprene - White
- Neoprene Sponge - Closed Cell
- Silicone - Gray

Hydraulic Seals

- Loaded Lip Seals
- Metal Clad Wipers
- Metric Bonded Seals
- Metric Compact Piston Seals
- Metric Oil Seals
- Metric U-Cups
- Metric V Seals
- Metric Wipers
- Piston Cups
- Rod Wipers
- T-Seals
- U-Cups
- Vee Packings
- Wear Rings
- Wear Strips
- WV Packings

Custom Molded Rubber

Mandrel Built & Lathe Cut Products
 Rubber Roll Coverings
 Rubber / Fabric Products
 Rubber to Metal Bonding

Sheet Material

Black Rubber Sponge
 Open Cell
 Black Rubber - Cloth Inserted
 Butyl
 Chipboard
 Compressed Non-Asbestos
 Cork
 Cork and Buna-N
 Cork and Neoprene
 Cork and Neoprene Spiral
 Ribbon
 Cork and Synthetic Rubber
 Adhesive Backed
 EPDM
 Felt - Gray, White, & Green
 Fibre-Cork
 Fiberglass Cloth
 Fiberglass Wire Inserted
 Tacky Cloth
 Filled PTFE
 Fish Paper
 Flexible Graphite
 Fluoroelastomer
 Fluoroelastomer - Nylon Inserted
 Gum Rubber
 Hypalon
 Leather
 Koroseal®
 Neoprene 40, 60, 70, &
 72 Durometer
 Neoprene Cotton and
 Nylon Inserted
 Nitrile 50, 60, & 90 Durometer
 Nitrile - White 50-65 Durometer
 Nitrile Sponge - Closed Cell
 Nitrile Nylon Inserted
 Nitrile - Transformer Grade
 Nomex® Paper
 Nylon
 PCTFE
 Plant (Vegetable) Fiber
 Red Rubber
 Silicone 50 and 70 Durometer
 Silicone Sponge
 Tank Gasket
 TFE and TFE Glass Filled
 Vinyl Matting
 Vulcanized Fiber
 Bone Hard - Red

Fabrication

Gaskets
 Water-jet Cut
 Steel Rule Die Cut
 Industrial Glass

Fabrication (Continued)

Pipeline Scraper Discs
 Stripping (with optional adhesive backing)
 Tank Strips & Gaskets
 Vulcanizing
 Non-Standard O-Rings
 Sleeves
 Gaskets

Spiral Wound Gaskets

304 Stainless Steel / Graphite
 316 Stainless Steel / Graphite

Packing

Aramid Filament
 Carbon / Graphite
 Carbon / TFE
 Flax and Flax / TFE
 General Service Packing
 G.F.O.®
 Graphite Filament
 Inconel Wire-Inserted
 Novoloid Fiber / PTFE
 Pre-Lubed TFE Yarn
 Pre-Lubed TFE Yarn (FDA)
 PTFE Cord Packing
 Stuffing Box Packing (S.B.S.)
 TFE Yarn
 Twisted Fiberglass Rope & Wick

Industrial Glass

Tubular Gauge Glass
 Standard
 High Pressure
 Red Line
 Heavy Wall
 Heavy Wall Red Line
 Borosilicate Flat Glass
 Circles
 Rectangles
 Squares
 Flat Gauge Glass
 Plain
 High Pressure
 Reflex
 Vycor® Brand Flat Glass
 Circles
 Rectangles
 Squares
 Pyrex® Brand Annular Edge
 Sight Glass
 Annealed
 Tempered
 Fused Quartz
 Circles
 Rectangles
 Squares
 Glass Accessories
 Guard Rods - Brass
 Water Gauges - Brass
 Gauge Glass Cutters

Industrial Glass (Continued)

Glass Accessories (continued)
 Gauge Glass Gaskets
 PCTFE Shields
 Mica Shields

Plastic Product , Die Cut

Replacement Safety Visors
 Safety Visor Headgear
 Safety Visor Hardhat Adapters
 Replacement Lenses for
 Sandblasting Helmets
 Plastics for the Printing Industry
 Custom Fabricated Die-Cut
 Plastic Products

Plastic Product , Machined

Custom Designs
 Back-Up Rings
 Guide Rings
 Rod Seals
 Piston Rings
 Wipers

Specialty & Miscellaneous

Fastener Seals
 Thread Seals
 Mechanical Seal Components
 O-Ring Groove Seats
 Ceramic
 Tungsten-Carbide
 Silicon-Carbide

Tools

Gasket Cutters
 Gasket Knives
 Gauge Glass Cutters
 Packing Hooks
 O-Ring Picks
 Punches & Punch Sets
 Clamping System Tools

Tapes

Fiberglass
 Kapton®
 Polyester
 Silicone Adhesive Backed
 Solid
 Silicone Adhesive Backed
 Sponge
 Teflon® Fiberglass
 TFE Pipe Thread Tape

Adhesives

PTFE Flange Sealant
 Stop-It® Pipe Repair System

24/7 Call Out Service



CALL US

EMAIL

FAX

WALK-IN

"AMERICA'S MOST RESPONSIVE WAREHOUSE"