

CAB760M12HM3R

1200 V, 760 A, Silicon Carbide

High-Performance, Half-Bridge Module

V_{DS}	1200 V
I_{DS}	760 A

Technical Features

- Low Inductance, Low Profile 62mm Footprint
- High Junction Temperature (175 °C) Operation
- Implements Switching Optimized Third Generation SiC MOSFET Technology
- Light Weight AlSiC Baseplate
- High Reliability Silicon Nitride Insulator

Package 110mm x 65 mm x 12.2 mm

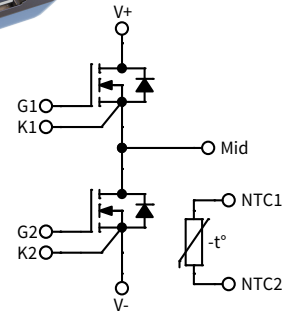

Applications

- Railway & Traction
- Solar
- EV Chargers
- Industrial Automation & Testing

System Benefits

- Lightweight, Compact Form Factor with 62mm Compatible Baseplate Enables System Retrofit
- Increased System Efficiency, due to Low Switching & Conduction Losses of SiC
- High Reliability Material Selection

Key Parameters ($T_C = 25^\circ\text{C}$ unless otherwise specified)

Symbol	Parameter	Min.	Typ.	Max.	Unit	Test Conditions	Note
$V_{DS\ max}$	Drain-Source Voltage			1200	V		
$V_{GS\ max}$	Gate-Source Voltage, Maximum Value	-8		+19		Transient, <100 ns	Fig. 33
$V_{GS\ op}$	Gate-Source Voltage, Recommended Op. Value	-4		+15		Static	
I_{DS}	DC Continuous Drain Current		1015		A	$V_{GS} = 15\text{ V}, T_C = 25^\circ\text{C}, T_{VJ} \leq 175^\circ\text{C}$	Fig. 20
			765			$V_{GS} = 15\text{ V}, T_C = 90^\circ\text{C}, T_{VJ} \leq 175^\circ\text{C}$	
I_{SD}	DC Source-Drain Current		1015			$V_{GS} = 15\text{ V}, T_C = 25^\circ\text{C}, T_{VJ} \leq 175^\circ\text{C}$	
$I_{SD\ BD}$	DC Source-Drain Current (Body Diode)		515			$V_{GS} = -4\text{ V}, T_C = 25^\circ\text{C}, T_{VJ} \leq 175^\circ\text{C}$	
$I_{DS\ (pulsed)}$	Maximum Pulsed Drain-Source Current			1530		t_{Pmax} limited by $T_{VJ\ max}$ $V_{GS} = 15\text{ V}, T_C = 25^\circ\text{C}$	
$I_{SD\ (pulsed)}$	Maximum Pulsed Source-Drain Current			1530			
$T_{VJ\ op}$	Maximum Virtual Junction Temperature under Switching Conditions	-40		175	$^\circ\text{C}$		

MOSFET Characteristics (Per Position) ($T_{VJ} = 25^\circ\text{C}$ unless otherwise specified)

Symbol	Parameter	Min.	Typ.	Max.	Unit	Test Conditions	Note
$V_{(BR)DSS}$	Drain-Source Breakdown Voltage	1200			V	$V_{GS} = 0\text{ V}, T_{VJ} = -40^\circ\text{C}$	
$V_{GS(th)}$	Gate Threshold Voltage	1.8	2.5	3.6		$V_{DS} = V_{GS}, I_D = 280\text{ mA}$	
			2.0			$V_{DS} = V_{GS}, I_D = 280\text{ mA}, T_{VJ} = 175^\circ\text{C}$	
I_{DSS}	Zero Gate Voltage Drain Current		15	400	μA	$V_{GS} = 0\text{ V}, V_{DS} = 1200\text{ V}$	
I_{GSS}	Gate-Source Leakage Current		0.12	3		$V_{GS} = 15\text{ V}, V_{DS} = 0\text{ V}$	
$R_{DS(on)}$	Drain-Source On-State Resistance (Devices Only)		1.33	1.73	m Ω	$V_{GS} = 15\text{ V}, I_D = 760\text{ A}$	Fig. 2 Fig. 3
			2.13			$V_{GS} = 15\text{ V}, I_D = 760\text{ A}, T_{VJ} = 175^\circ\text{C}$	
g_{fs}	Transconductance		548		S	$V_{DS} = 20\text{ V}, I_{DS} = 760\text{ A}$	Fig. 4
			585			$V_{DS} = 20\text{ V}, I_{DS} = 760\text{ A}, T_{VJ} = 175^\circ\text{C}$	
E_{On}	Turn-On Switching Energy, $T_{VJ} = 25^\circ\text{C}$ $T_{VJ} = 125^\circ\text{C}$ $T_{VJ} = 175^\circ\text{C}$		20.3 20.7 23.7		mJ	$V_{DS} = 600\text{ V},$ $I_D = 760\text{ A},$ $V_{GS} = -4\text{ V}/15\text{ V},$ $R_{G(ext)} = 1.0\ \Omega,$ $L = 13.7\ \mu\text{H}$	Fig. 11 Fig. 13
E_{Off}	Turn-Off Switching Energy, $T_{VJ} = 25^\circ\text{C}$ $T_{VJ} = 125^\circ\text{C}$ $T_{VJ} = 175^\circ\text{C}$		17.9 17.5 17.8				
$R_{G(int)}$	Internal Gate Resistance		0.47		Ω	$V_{AC} = 25\text{ mV}, f = 100\text{ kHz}$	
C_{iss}	Input Capacitance		79.4		nF	$V_{GS} = 0\text{ V}, V_{DS} = 800\text{ V},$ $V_{AC} = 25\text{ mV}, f = 100\text{ kHz}$	Fig. 9
C_{oss}	Output Capacitance		2.9				
C_{rss}	Reverse Transfer Capacitance		90				
Q_{GS}	Gate to Source Charge		768		nC	$V_{DS} = 800\text{ V}, V_{GS} = -4\text{ V}/15\text{ V}$ $I_D = 760\text{ A}$ Per IEC60747-8-4 pg 21	
Q_{GD}	Gate to Drain Charge		924				
Q_G	Total Gate Charge		2724				
R_{thJC}	FET Thermal Resistance, Junction to Case		0.068	0.073	$^\circ\text{C}/\text{W}$		Fig. 17

Diode Characteristics (Per Position) ($T_{VJ} = 25^\circ\text{C}$ unless otherwise specified)

Symbol	Parameter	Min.	Typ.	Max.	Unit	Test Conditions	Note
V_{SD}	Body Diode Forward Voltage		5.4		V	$V_{GS} = -4\text{ V}, I_{SD} = 760\text{ A}$	Fig. 7
			4.7			$V_{GS} = -4\text{ V}, I_{SD} = 760\text{ A}, T_{VJ} = 175^\circ\text{C}$	
t_{rr}	Reverse Recovery Time		49		ns	$V_{GS} = -4\text{ V}, I_{SD} = 760\text{ A}, V_R = 600\text{ V}$ $di/dt = 20\text{ A/ns}, T_{VJ} = 175^\circ\text{C}$	Fig. 32
Q_{RR}	Reverse Recovery Charge		17.0		μC		
I_{RRM}	Peak Reverse Recovery Current		540		A		
E_{RR}	Reverse Recovery Energy $T_{VJ} = 25^\circ\text{C}$ $T_{VJ} = 125^\circ\text{C}$ $T_{VJ} = 175^\circ\text{C}$		1.3 3.5 5.5		mJ	$V_{DS} = 600\text{ V}, I_D = 760\text{ A},$ $V_{GS} = -4\text{ V}/15\text{ V}, R_{G(ext)} = 1.0\ \Omega,$ $L = 13.7\ \mu\text{H}$	Fig. 14



Module Physical Characteristics

Symbol	Parameter	Min.	Typ.	Max.	Unit	Test Conditions
R ₁₋₂	Package Resistance, M1		106.5		μΩ	T _C = 125 °C, Note 1
R ₂₋₃	Package Resistance, M2		126.3			T _C = 125 °C, Note 1
L _{Stray}	Stray Inductance		4.9		nH	Between Terminals 1 and 3
T _C	Case Temperature	-40		125	°C	
W	Weight		179		g	
M _S	Mounting Torque	3	4.5	5	N-m	Baseplate, M6 bolts
		0.9	1.1	1.3		Power Terminals, M4 bolts
V _{isol}	Case Isolation Voltage	4			kV	AC, 50 Hz, 1 min
CTI	Comparative Tracking Index	600				
	Clearance Distance	13.07			mm	Terminal to Terminal
		6.00				Terminal to Baseplate
	Creepage Distance	14.27				Terminal to Terminal
		12.34				Terminal to Baseplate

Note 1 Total Effective Resistance (Per Switch Position) = MOSFET R_{DS(on)} + Switch Position Package Resistance.

Temperature Sensor (NTC) Characteristics

Symbol	Parameter	Min.	Typ.	Max.	Unit	Test Conditions
R ₂₅	Resistance at 25°C		4700		Ω	T _{NTC} = 25 °C
	Tolerance of R ₂₅			±1	%	
B _{25/85}	Beta Value for 25°C to 85°C		3435		K	
B _{0/100}	Beta Value for 0°C to 100°C		3399		K	
	Tolerance of B _{25/85}			±1	%	
P ₂₅	Maximum Power Dissipation			50	mW	

Steinhart & Hart Coefficients for NTC Resistance & NTC Temperature Computation (T in K)

$$\ln\left(\frac{R}{R_{25}}\right) = A + \frac{B}{T} + \frac{C}{T^2} + \frac{D}{T^3}$$

$$\frac{1}{T} = A_1 + B_1 \ln\left(\frac{R}{R_{25}}\right) + C_1 \ln^2\left(\frac{R}{R_{25}}\right) + D_1 \ln^3\left(\frac{R}{R_{25}}\right)$$

A	B	C	D
-1.289E+01	4.245E+03	-8.749E+04	-9.588E+06

A ₁	B ₁	C ₁	D ₁
3.354E-03	3.001E-04	5.085E-06	2.188E-07

Typical Performance

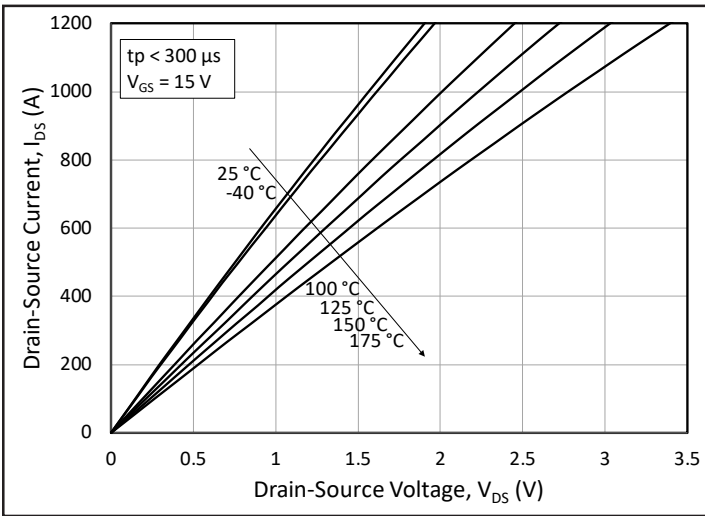

Figure 1. Output Characteristics for Various Junction Temperatures

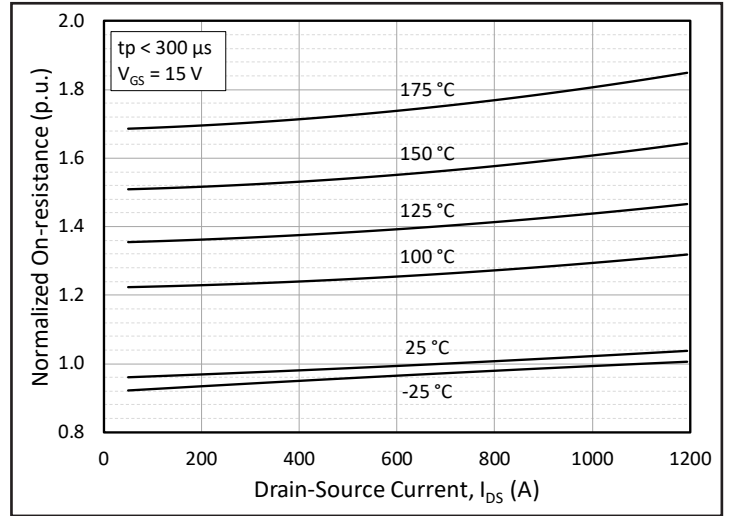

Figure 2. Normalized On-State Resistance vs. Drain Current for Various Junction Temperatures

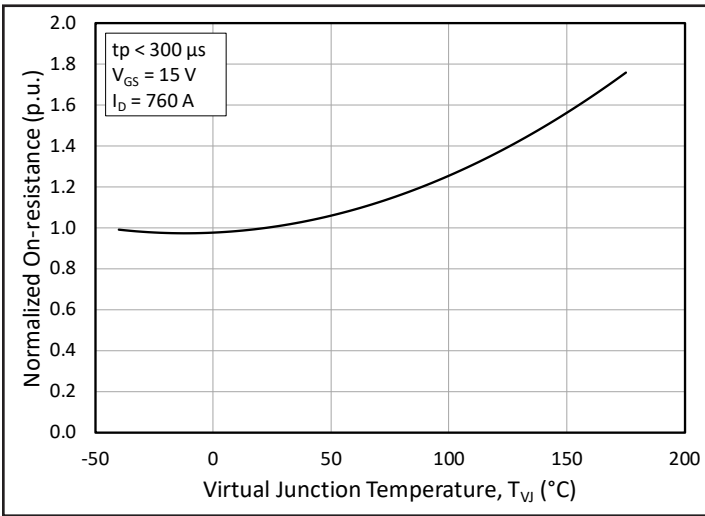

Figure 3. Normalized On-State Resistance vs. Junction Temperature

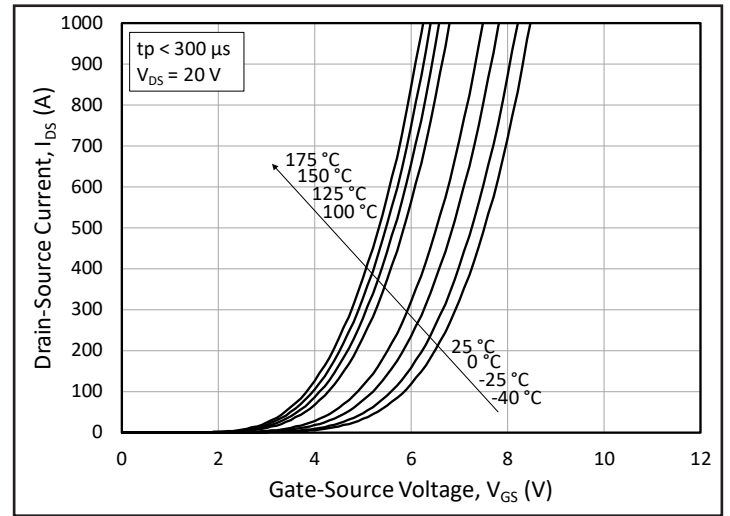

Figure 4. Transfer Characteristic for Various Junction Temperatures

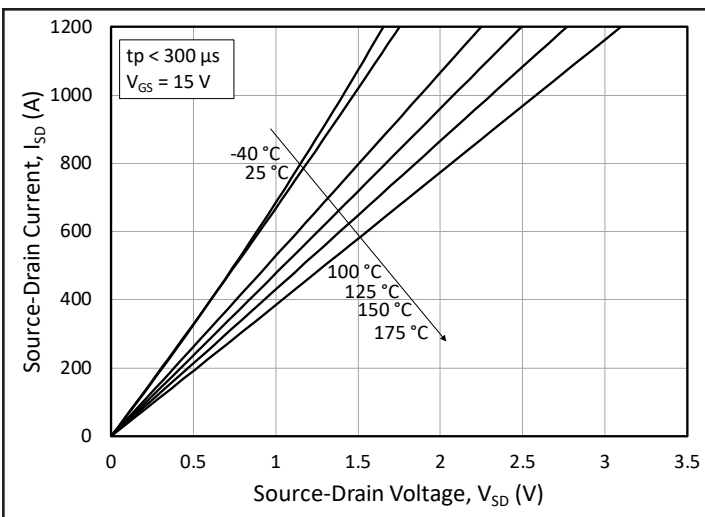

Figure 5. 3rd Quadrant Characteristic vs. Junction Temperatures at $V_{GS} = 15\text{ V}$

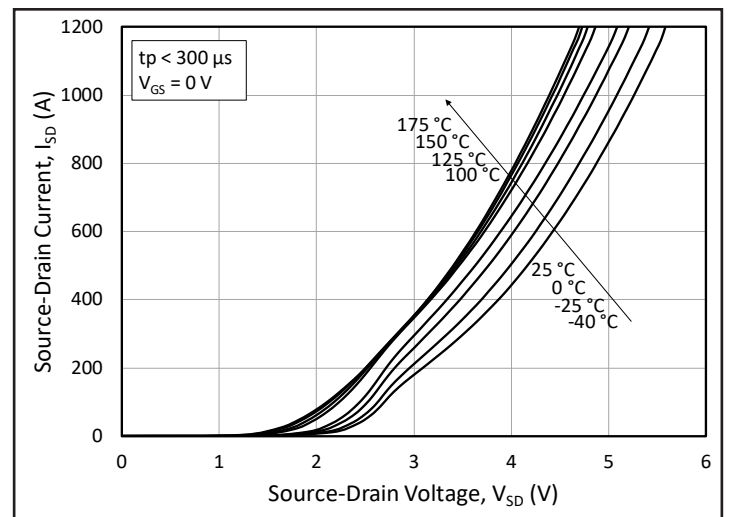

Figure 6. 3rd Quadrant Characteristic vs. Junction Temperatures at $V_{GS} = 0\text{ V}$ (Body Diode)

Typical Performance

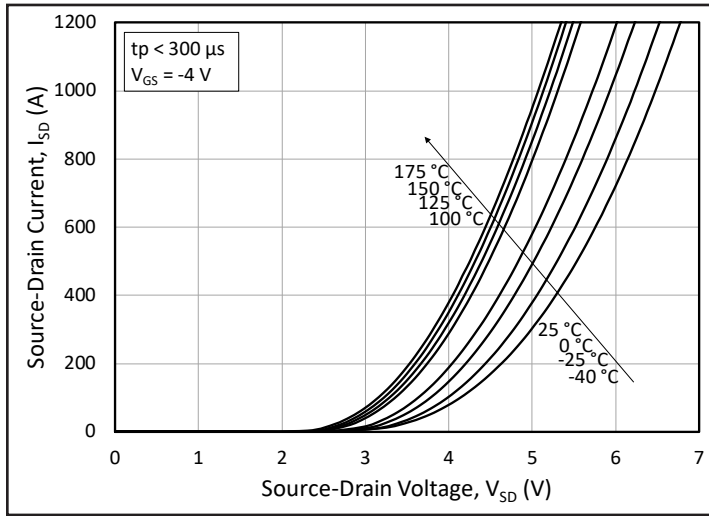

Figure 7. 3rd Quadrant Characteristic vs. Junction Temperatures at $V_{GS} = -4\text{ V}$ (Body Diode)

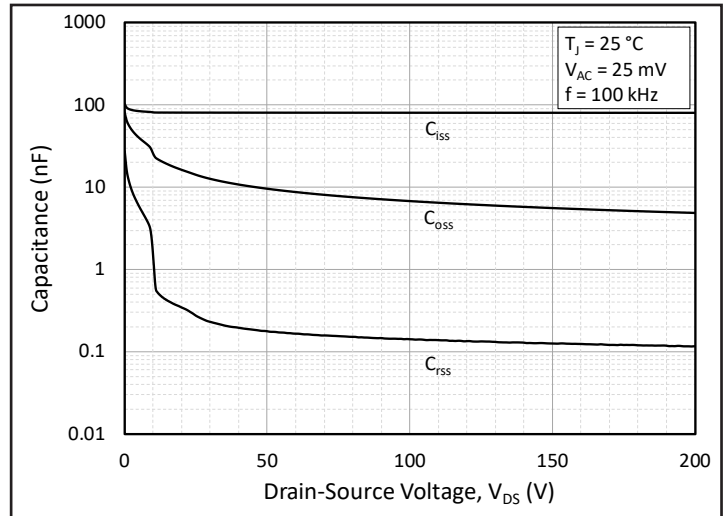

Figure 8. Typical Capacitances vs. Drain to Source Voltage (0 - 200V)

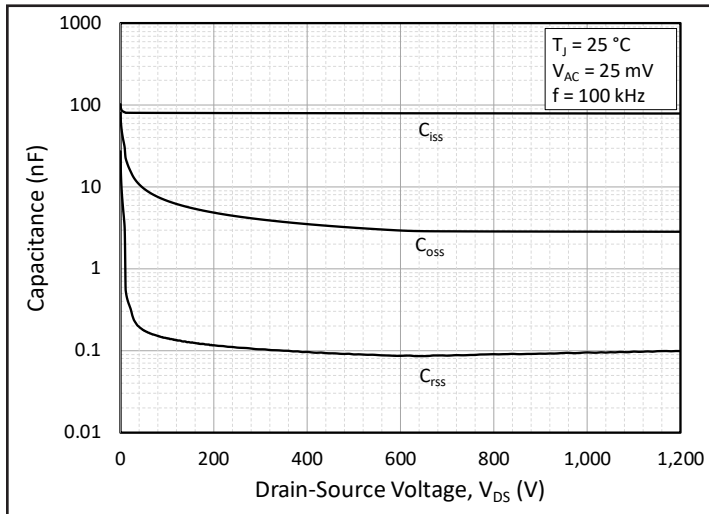

Figure 9. Typical Capacitances vs. Drain to Source Voltage (0 - 1200V)

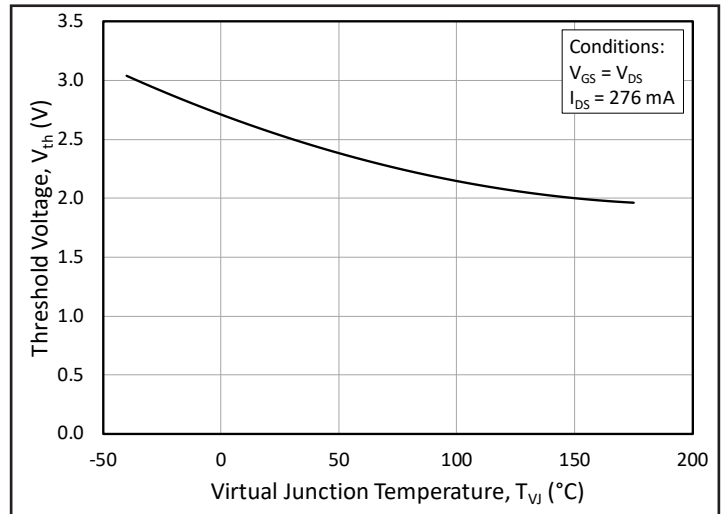

Figure 10. Threshold Voltage vs. Junction Temperature

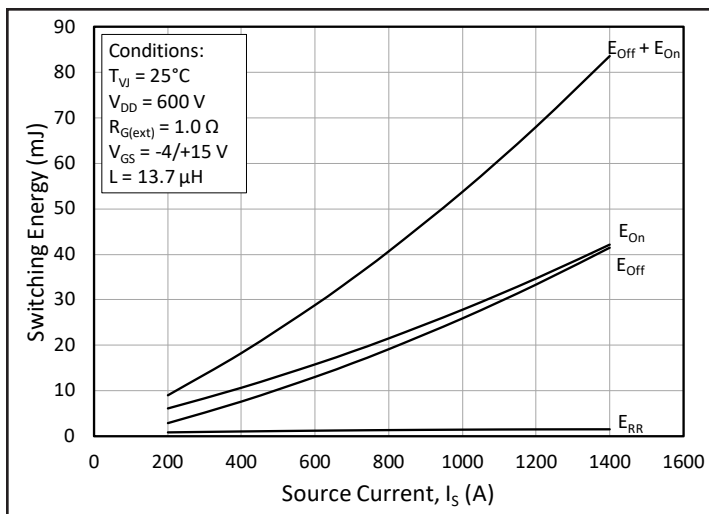

Figure 11. Switching Energy vs. Drain Current ($V_{DS} = 600\text{ V}$)

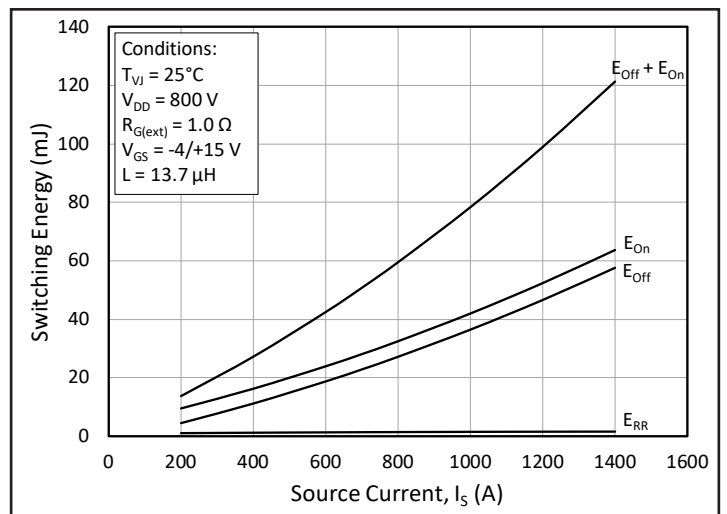

Figure 12. Switching Energy vs. Drain Current ($V_{DS} = 800\text{ V}$)



Typical Performance

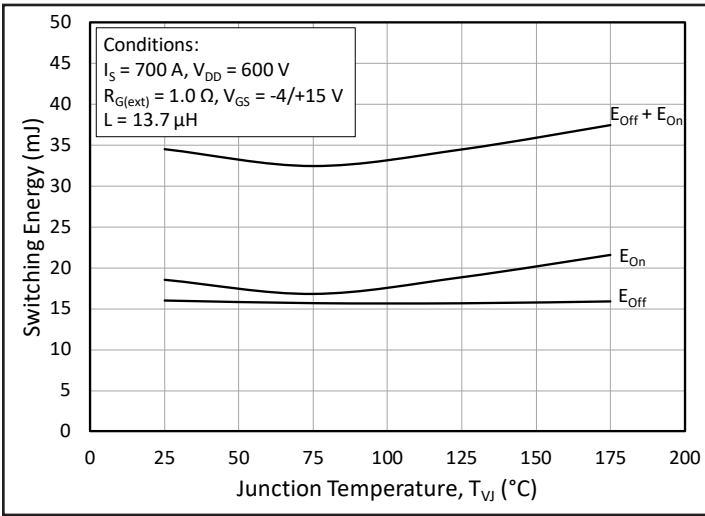

Figure 13. MOSFET Switching Energy vs. Junction Temperature

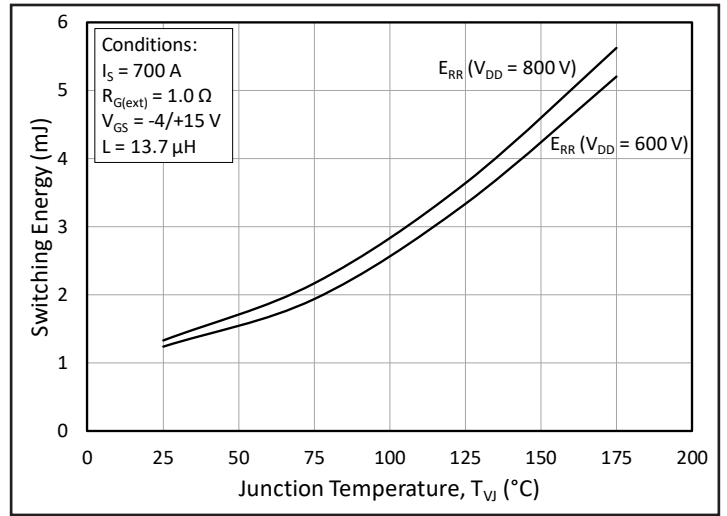

Figure 14. Reverse Recovery Energy vs. Junction Temperature

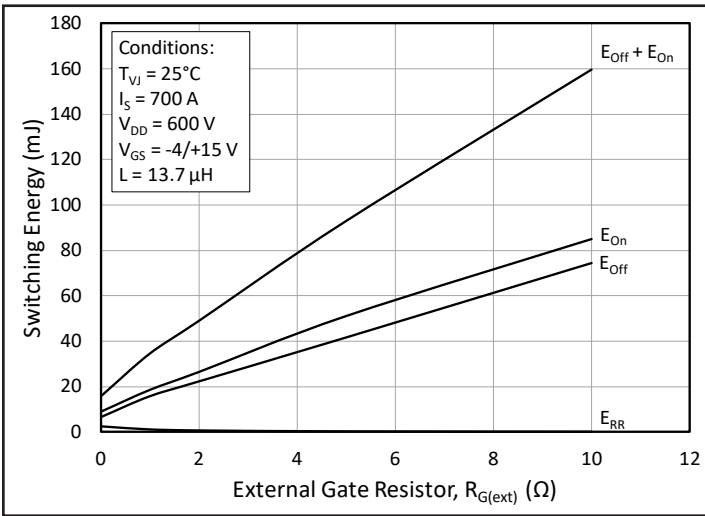

Figure 15. MOSFET Switching Energy vs. External Gate Resistance

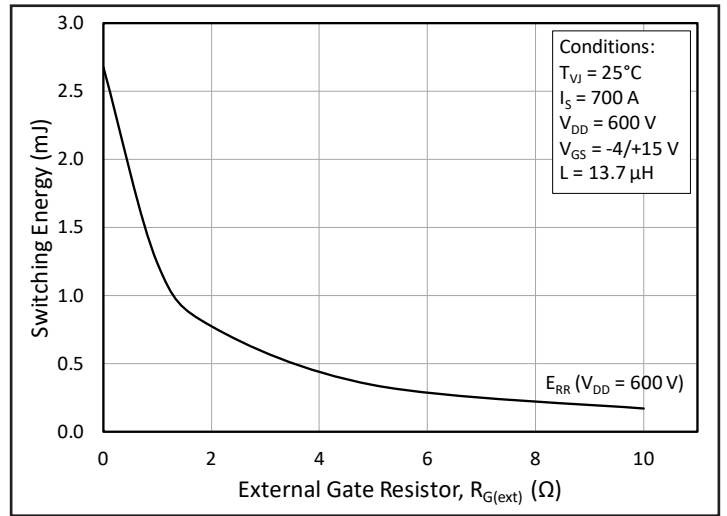

Figure 16. Reverse Recovery Energy vs. External Gate Resistance

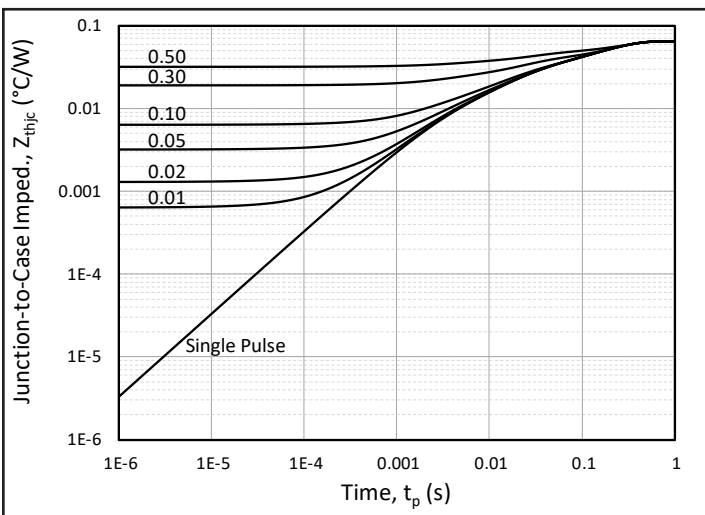

Figure 17. MOSFET Junction to Case Transient Thermal Impedance, $Z_{th,jc}$ ($^{\circ}\text{C}/\text{W}$)

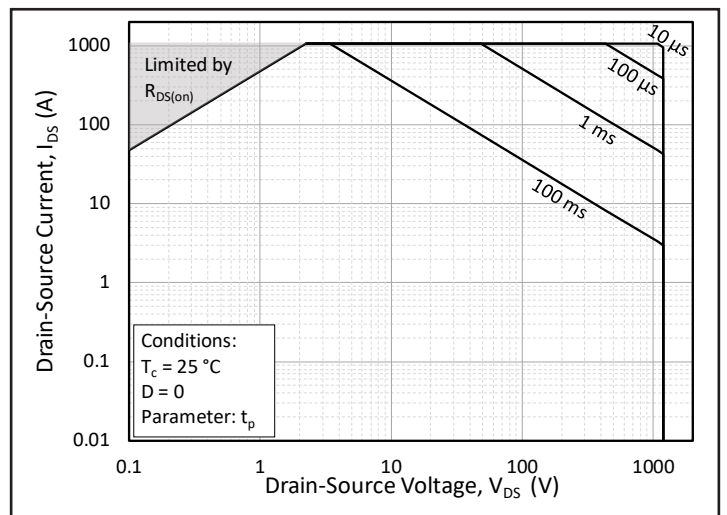

Figure 18. Forward Bias Safe Operating Area (FBSOA)

Typical Performance

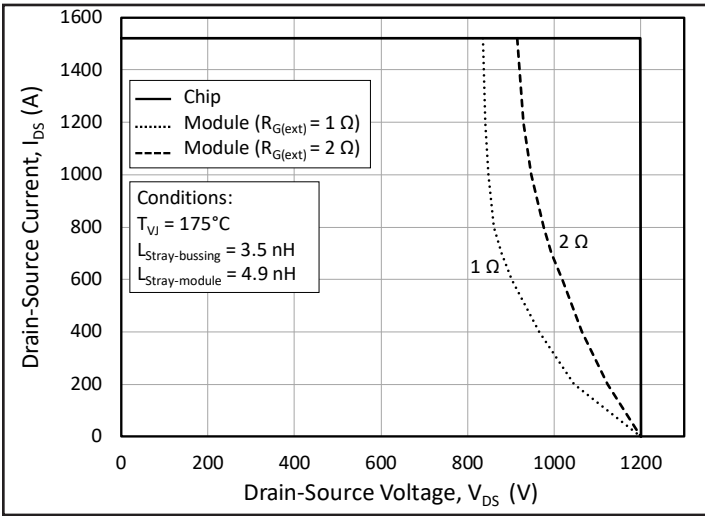

Figure 19. Reverse Bias Safe Operating Area (RBSOA)

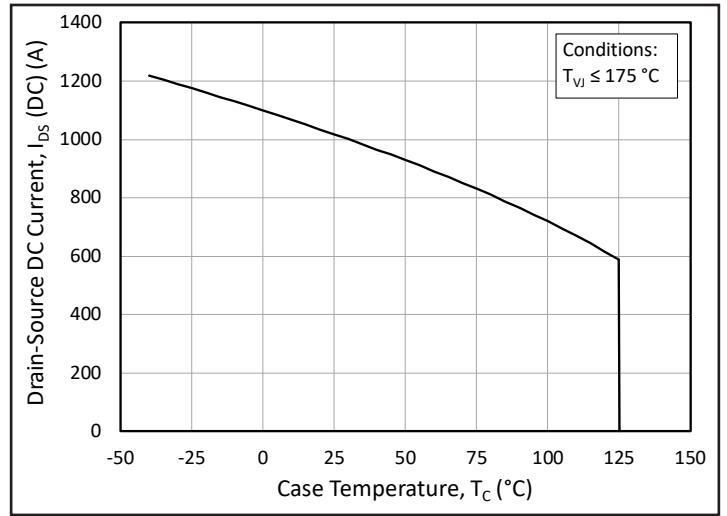

Figure 20. Continuous Drain Current Derating vs. Case Temperature

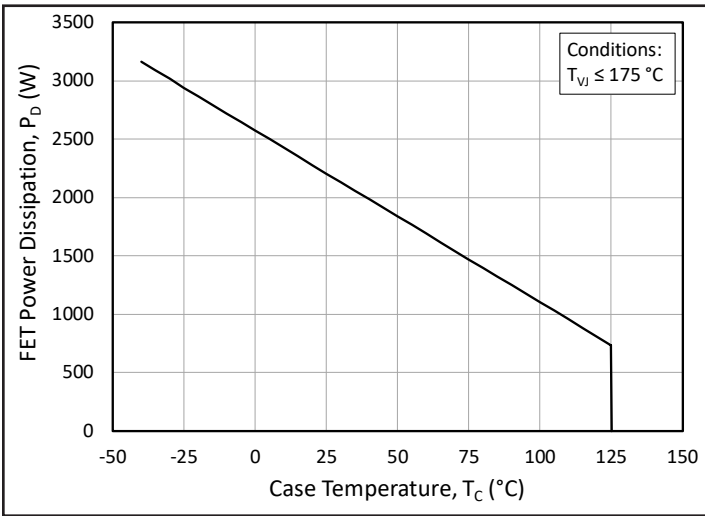

Figure 21. Maximum Power Dissipation Derating vs. Case Temperature

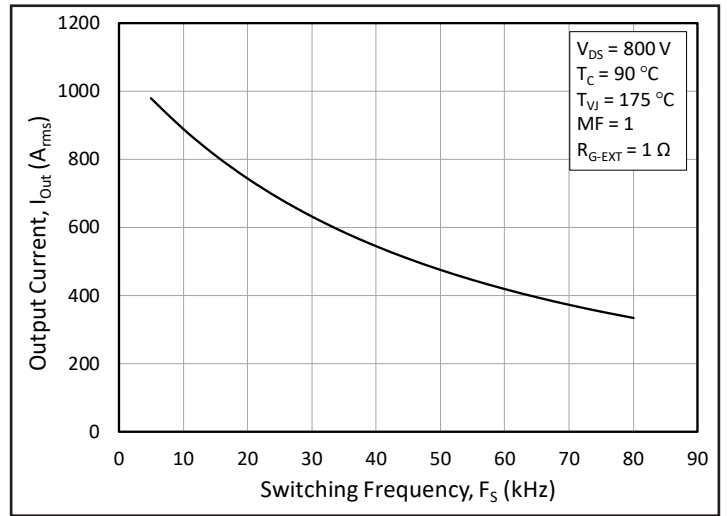

Figure 22. Typical Output Current Capability vs. Switching Frequency (Inverter Application)

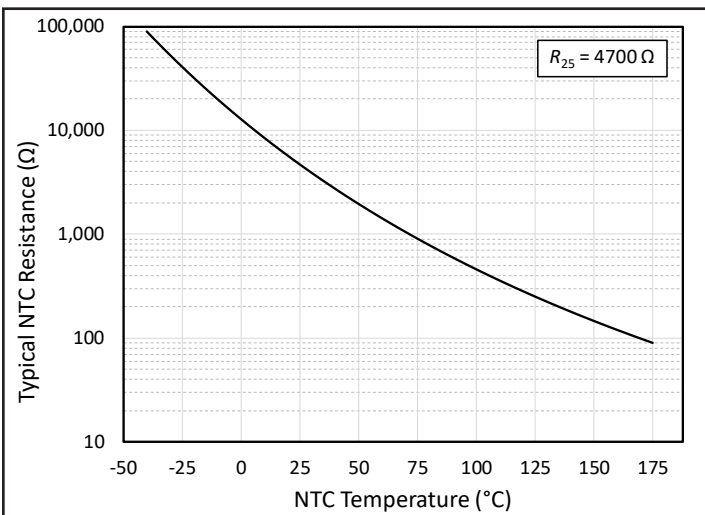

Figure 23. Typical NTC Resistance vs. Temperature



Timing Characteristics

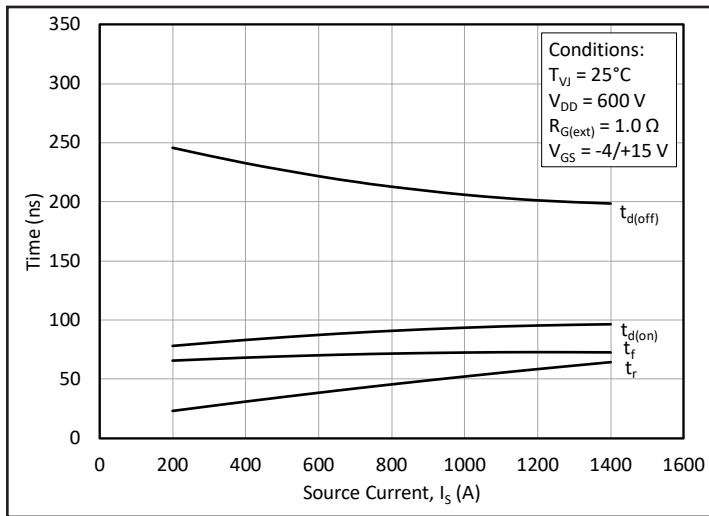

Figure 24. Timing vs. Source Current

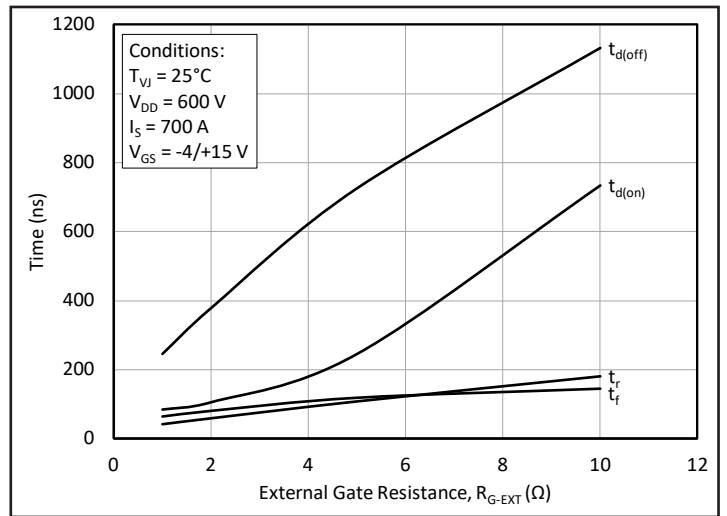

Figure 25. Timing vs. External Gate Resistance

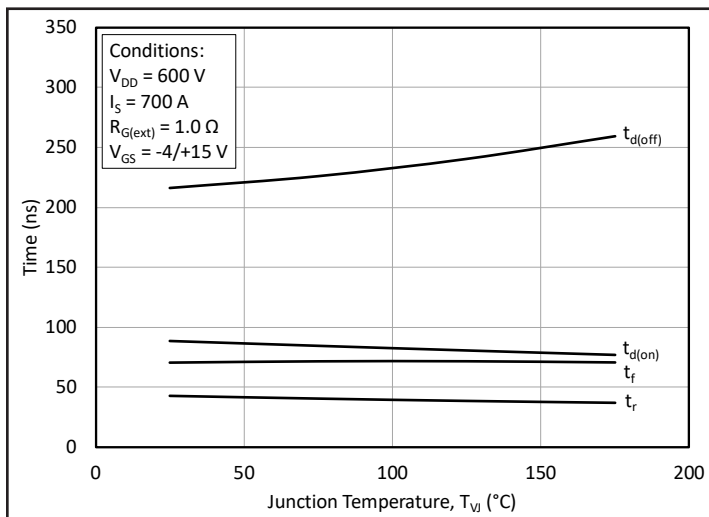

Figure 26. Timing vs. Junction Temperature

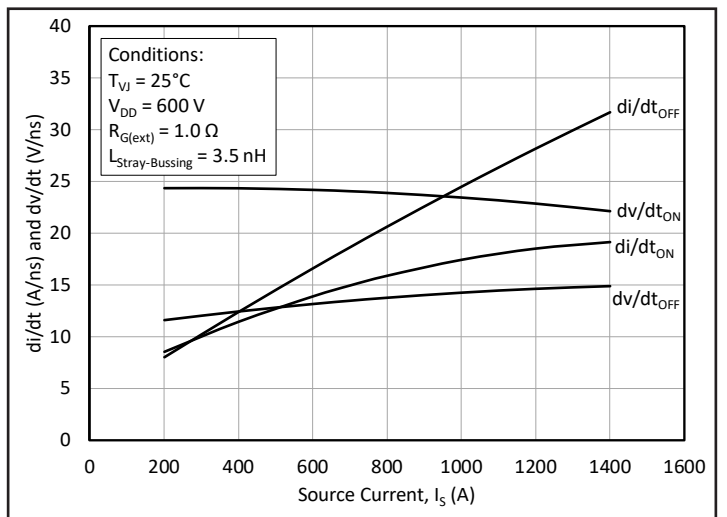

Figure 27. dv/dt and di/dt vs. Source Current

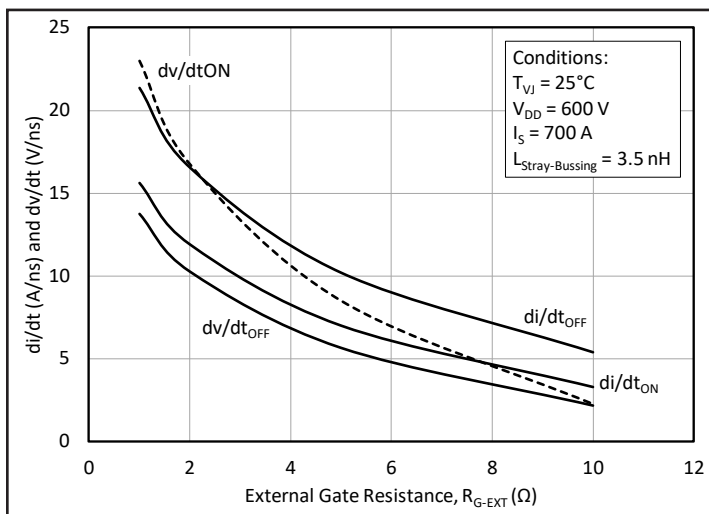

Figure 28. dv/dt and di/dt vs. External Gate Resistance

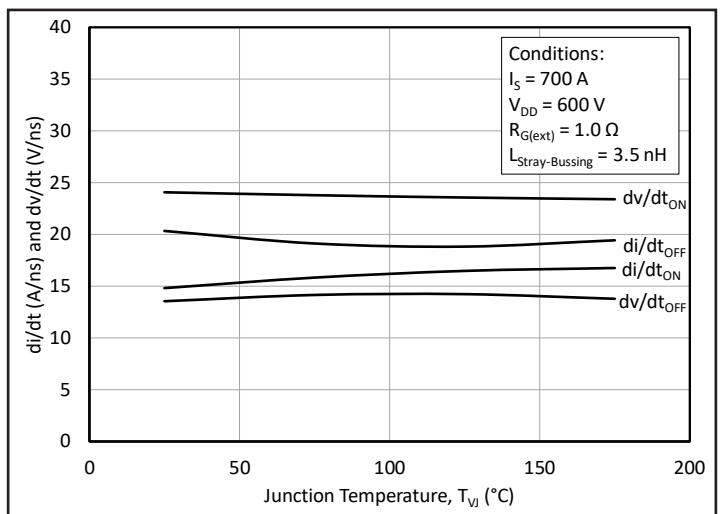

Figure 29. dv/dt and di/dt vs. Junction Temperature



Definitions

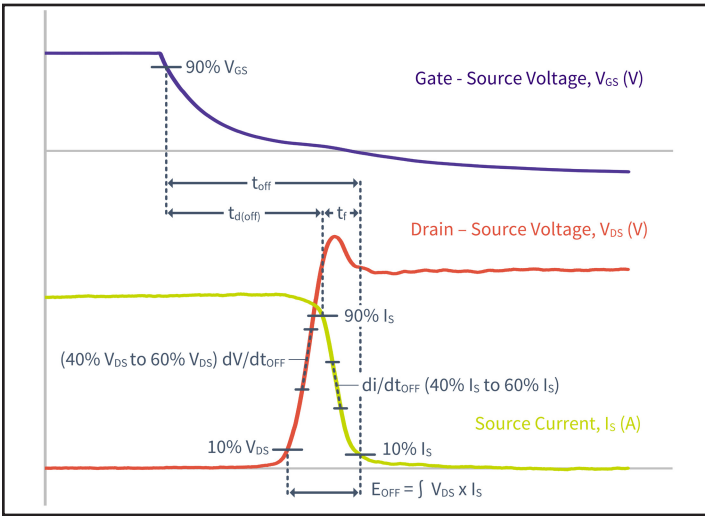

Figure 30. Turn-off Transient Definitions

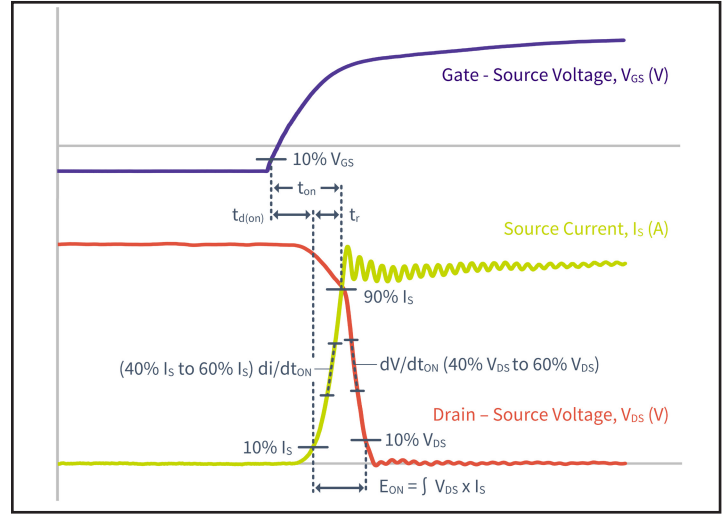

Figure 31. Turn-on Transient Definitions

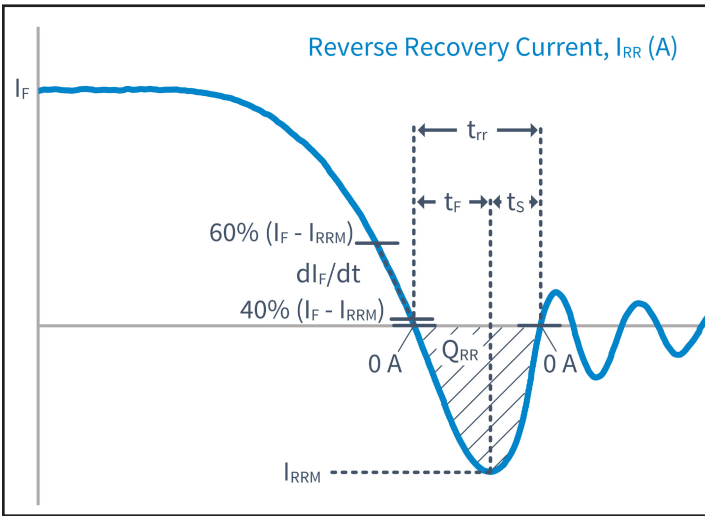

Figure 32. Reverse Recovery Definitions

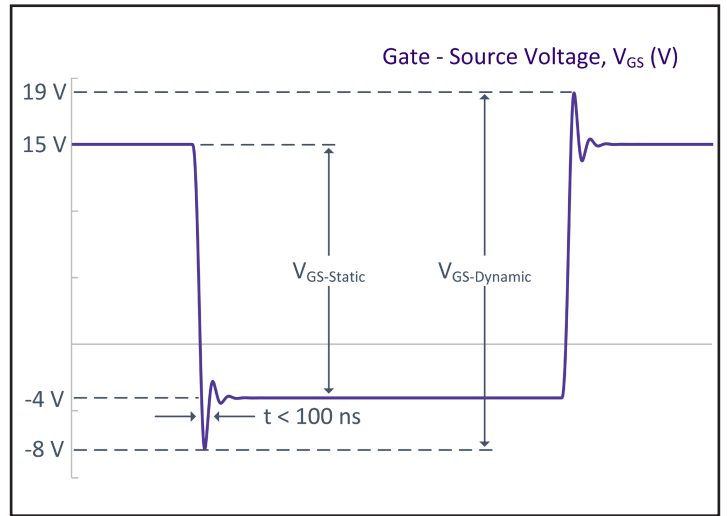
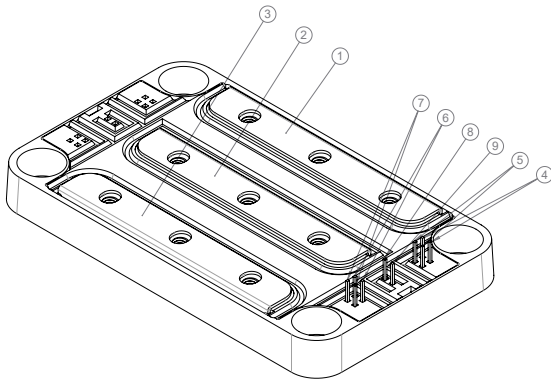

Figure 33. V_{GS} Transient Definitions



Schematic and Pin Out



PIN OUT SCHEME	
PIN	LABEL
①	V+
②	Mid
③	V-
④	G1, Top row pins (2)
⑤	K1, Bottom row pins (2)
⑥	G2, Top row pins (2)
⑦	K2, Bottom row pins (2)
⑧	NTC1
⑨	NTC2

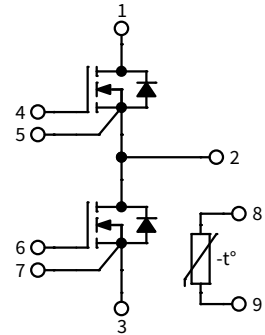

Package Dimensions (mm)

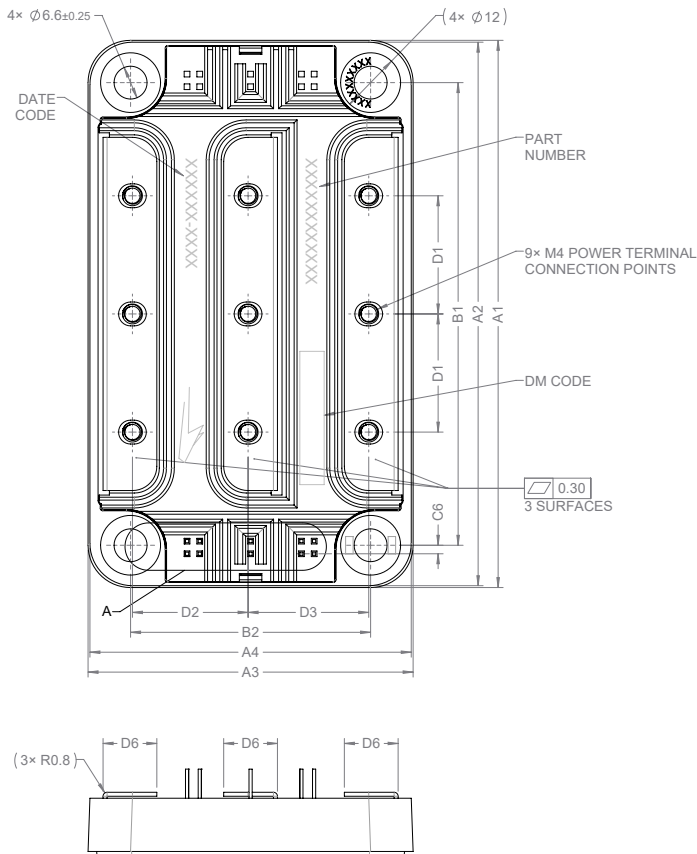

NOTE:
ALL MARKINGS SHALL
CONFORM TO PRC-00786.

DIMENSION TABLE		
SYMBOL	DIMENSION	TOLERANCE
A1	110.00	±0.60
A2	109.25	±0.60
A3	65.00	±0.60
A4	64.25	±0.60
A5	3.25	±0.30
A6	11.45	±0.60
B1	93.00	±0.30
B2	48.00	±0.30
C1	11.30	±0.40
C2	13.84	±0.40
C3	24.00	±0.40
C4	34.16	±0.40
C5	36.70	±0.40
C6	1.71	±0.40
C7	17.30	±0.50
C8	2.54	±0.30
C9	0.64	±0.30
C10	10.16	±0.40
D1	23.75	±0.50
D2	23.13	±0.50
D3	24.13	±0.50
D4	12.20	±0.50
D5	71.00	±0.30
D6	10.75	±0.30

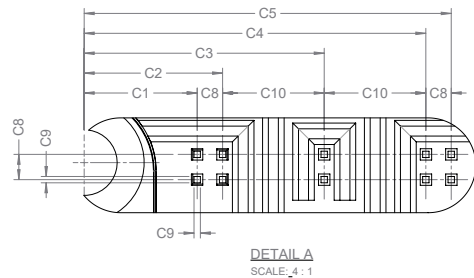

Supporting Links & Tools

- [CGD1700HB3P-HM3 Evaluation Gate Driver](#)
- [CGD12HB00D: Differential Transceiver Board](#)
- [CPWR-AN35: Thermal Interface Material Application Note](#)
- [CPWR-AN39: KIT-CRD-CIL12N-HM User Guide](#)
- [KIT-CRD-CIL12N-HM: Dynamic Performance Evaluation Board for the HM2 and HM3 Module](#)
- [CAB760M12HM3 PLECS Models](#)

Notes

This document and the information contained herein are subject to change without notice. Any such change shall be evidenced by the publication of an updated version of this document by Cree. No communication from any employee or agent of Cree or any third party shall effect an amendment or modification of this document. No responsibility is assumed by Cree for any infringement of patents or other rights of third parties which may result from use of the information contained herein. No license is granted by implication or otherwise under any patent or patent rights of Cree.

Notwithstanding any application-specific information, guidance, assistance, or support that Cree may provide, the buyer of this product is solely responsible for determining the suitability of this product for the buyer's purposes, including without limitation for use in the applications identified in the next bullet point, and for the compliance of the buyers' products, including those that incorporate this product, with all applicable legal, regulatory, and safety-related requirements.

This product has not been designed or tested for use in, and is not intended for use in, applications in which failure of the product would reasonably be expected to cause death, personal injury, or property damage, including but not limited to equipment implanted into the human body, life-support machines, cardiac defibrillators, and similar emergency medical equipment, aircraft navigation, communication, and control systems, aircraft power and propulsion systems, air traffic control systems, and equipment used in the planning, construction, maintenance, or operation of nuclear facilities.

RoHS Compliance

The levels of RoHS restricted materials in this product are below the maximum concentration values (also referred to as the threshold limits) permitted for such substances, or are used in an exempted application, in accordance with EU Directive 2011/65/EC (RoHS2), as implemented January 2, 2013. RoHS Declarations for this product can be obtained from your Cree representative or from the Product Documentation sections of www.cree.com.

REACH Compliance

REACH substances of high concern (SVHCs) information is available for this product. Since the European Chemical Agency (ECHA) has published notice of their intent to frequently revise the SVHC listing for the foreseeable future, please contact your Cree representative to ensure you get the most up-to-date REACH SVHC Declaration. REACH banned substance information (REACH Article 67) is also available upon request.