

# NuWaves

## RF Solutions

### NuPower™ U-20-C01 UHF Solid State Power Amplifier

20 Watt, Typ  
225 MHz to 1000 MHz



P/N: NW-PA-U-20-C01-S01

(includes NW-PA-ACC-CB09MA interface cable)

**The NuPower™ U-20-C01 UHF Solid State Power Amplifier offers broadband operation spanning across UHF frequencies and delivers 20 Watts, Typ of RF power across the frequency range of 225 MHz to 1.0 GHz.**

Based on the latest gallium nitride (GaN) technology, NuPower's 35% - 60% power efficiency and 3.9 in<sup>3</sup> form factor brings state-of-the-art power amplifier technology to the warfighter, meeting present challenges in size and weight reduction.

**Extend your operational communication range with NuPower™ amplifiers from NuWaves RF Solutions.**

#### Features

- 20 Watts RF Output Power
- 225 MHz to 1.0 GHz
- Miniature Package (3.00" x 2.00" x 0.65")
- High-Efficiency GaN Technology
- 0 dBm Nominal RF Input
- Over-Voltage Protection
- Reverse-Voltage Protection
- Thermal Protection
- Logic On/Off Control

#### Benefits

- Extended Range
- Improved Link Margin
- Reduced load on DC power budget due to high efficiency operation
- Requires less volume on space-constrained platforms

#### Applications

- Unmanned Aircraft Systems (UAS), Group 2 & 3
- Unmanned Ground Vehicles (UGV)
- Broadband RF Telemetry
- RF Communication Systems
- Software Defined Radios
- Test Labs

# NuPower™ U-20-C01-S01 Power Amplifier

## Specifications

### Absolute Maximums

Parameter	Rating	Unit
Max Device Voltage	32	V
Max Device Current	2.4	A
Max RF Input Power, $Z_L = 50 \Omega$	10	dBm
Max Operating Temperature (ambient)	60	°C
Max Operating Temperature (baseplate)	85	°C
Max Storage Temperature	85	°C

Export Classification
EAR99

### Electrical Specifications @ 28 VDC, 25 °C, $Z_S = Z_L = 50 \Omega$

Parameter	Symbol	Min	Typ	Max	Unit	Condition
Operating Frequency	BW	225		1000	MHz	
RF Output Power	$P_{SAT}$	14	20		W	$P_{in} = 0$ dBm
Output Power @ 1dB Compression	P1dB		32		dBm	225 MHz
			32			325 MHz
			32			525 MHz
			32			725 MHz
			30			1000 MHz
Small Signal Gain	G		57		dB	225 MHz, @ -30 dBm input
			55			325 MHz, @ -30 dBm input
			56			525 MHz, @ -30 dBm input
			52			725 MHz, @ -30 dBm input
			49			1000 MHz, @ -30 dBm input
Small Signal Gain Flatness	$\Delta G$		$\pm 4$		dB	$P_{in} = -30$ dBm
Power Gain Flatness			$\pm 1$		dB	$P_{in} = 0$ dBm
Input VSWR	VSWR	1.05:1	2:1	3.4:1		
Nominal Input Drive Level	$P_{IN}$		0		dBm	
Operating Voltage	VDC	11	28	30	V	
Quiescent Current	$I_{BQ}$		0.610		A	28 VDC
Operating Current	$I_{DD}$		1.5	2.4	A	$P_{in} = 0$ dBm, 28 VDC
Module Efficiency			45		%	
Switching Speed	$TX_{ON/OFF}$			2	$\mu S$	10% to 90%
Harmonics	2nd		7		dBc	
	3rd		16			
Output Mismatch (No Damage)				10:1		

# NuPower™ U-20-C01-S01 Power Amplifier

## Specifications (cont.)

### Mechanical Specifications

Parameter	Value	Unit	Limits
Dimensions	3.0 x 2.0 x 0.65	in	Max
Weight	3	oz	Max
RF Connectors, Input/Output	SMA Female		
Interface Connector	Micro-D, 9-pin Socket		
Cooling	Adequate Heatsink Required		

### Environmental Specifications

Parameter	Symbol	Min	Typ	Max	Unit
Operating Temperature (ambient)	$T_A$	-40		+60	°C
Operating Temperature (baseplate)	$T_C$	-40		+85	°C
Storage Temperature	$T_{STG}$	-55		+85	°C
Relative Humidity (non-condensing)	RH			95	%
Altitude MIL-STD-810F - Method 500.4	ALT			30,000	ft
Vibration / Shock Profile  (Random profile in x,y, z axis, as per Figure for 15 minute duration in each axis)					

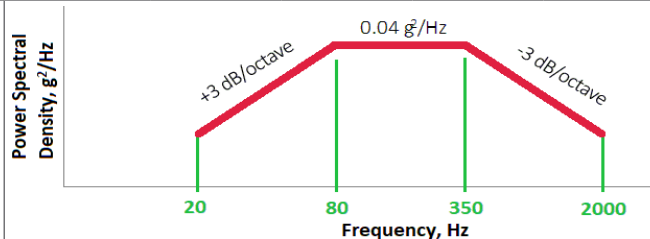

## Performance Plots

Test Conditions: +28 VDC, +25 °C,  $Z_S=Z_L=50 \Omega$

Output Power vs. Input Power

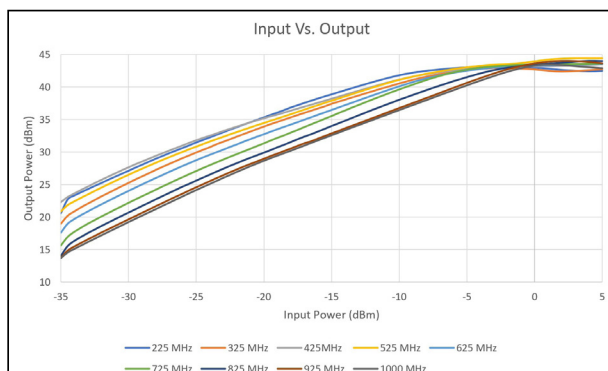

Harmonics @ Psat

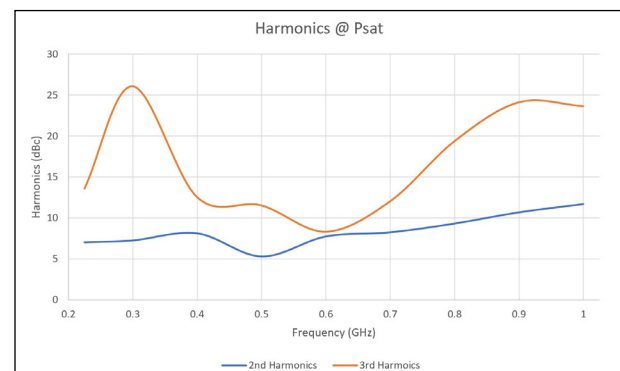

# NuPower™ U-20-C01-S01 Power Amplifier

## Performance Plots (cont.)

P1dB & P3dB

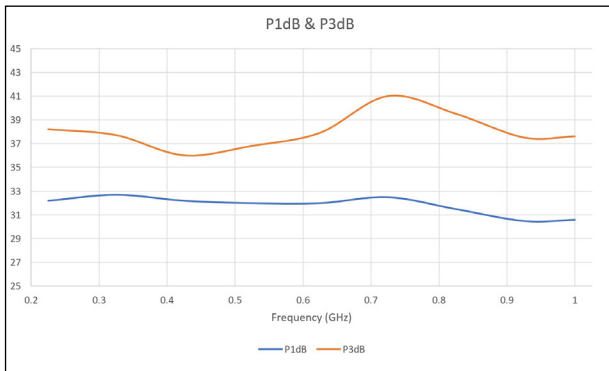

RF Output Power @ 0 dBm Input

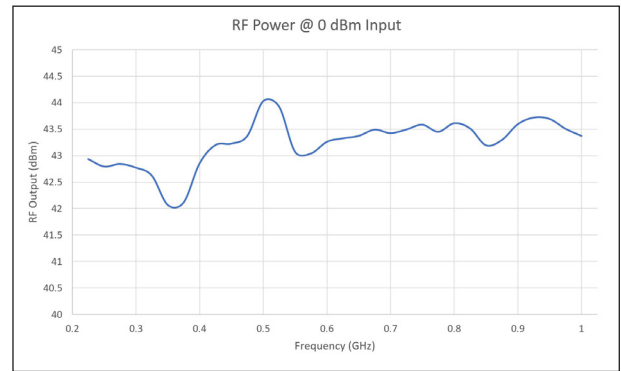

Power Added Efficiency @ 0 dBm Input

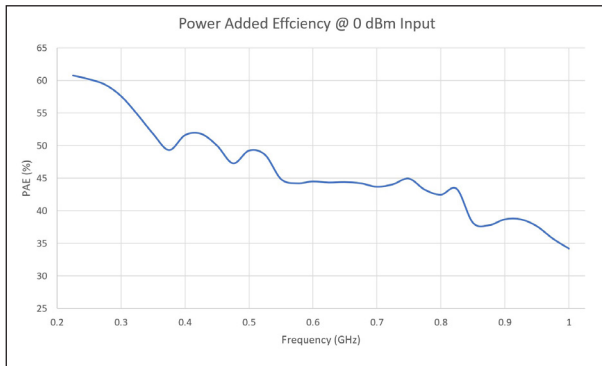

Small Signal Gain (-30 dBm Input)

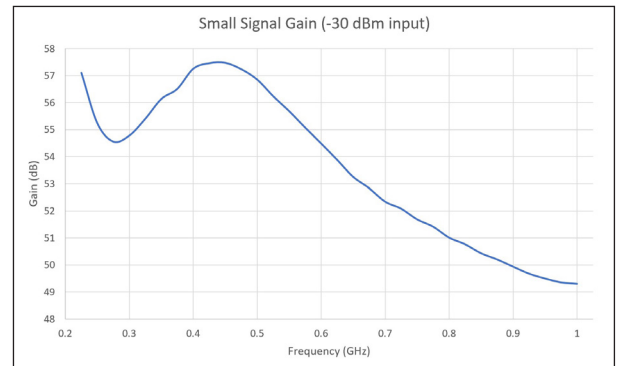

RF Output Power - Stepped Input

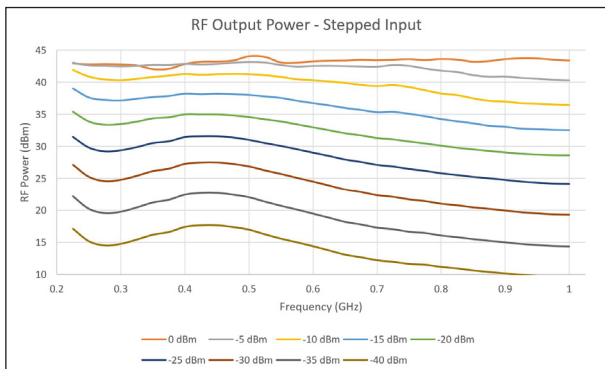

Input VSWR @ 0 dBm

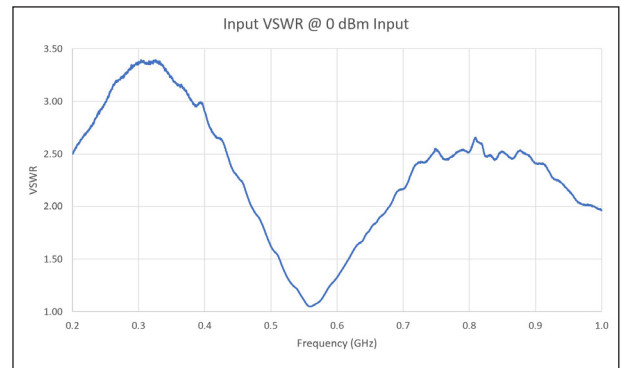

Current Consumption [+28VDC @ 0 dBm Input]

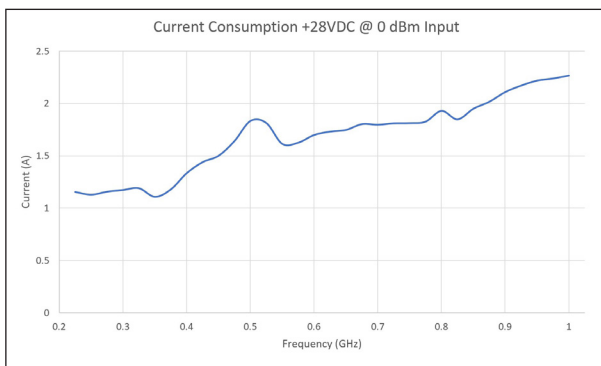

EVM vs. Input Power

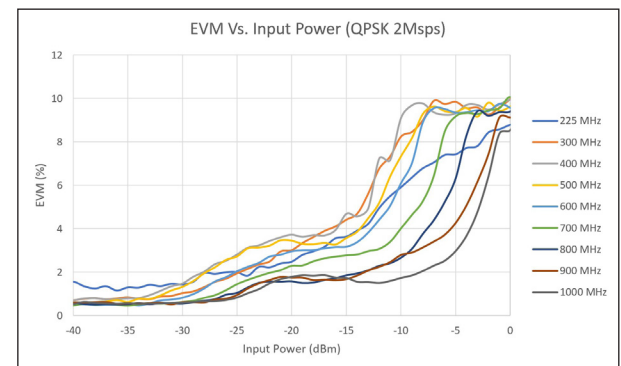

# NuPower™ U-20-C01-S01 Power Amplifier

## Performance Plots (cont.)

### EVM vs. Output Power

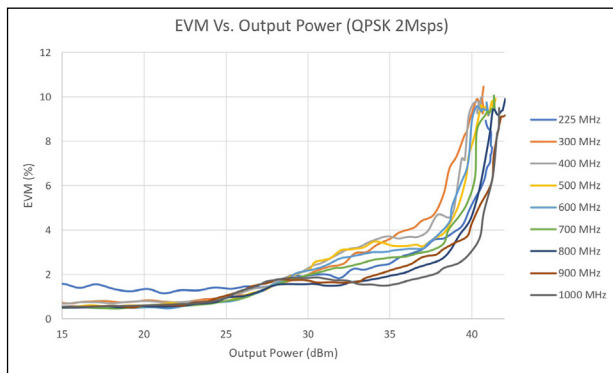

### EVM vs. Input Power (16-QAM 2Msps)

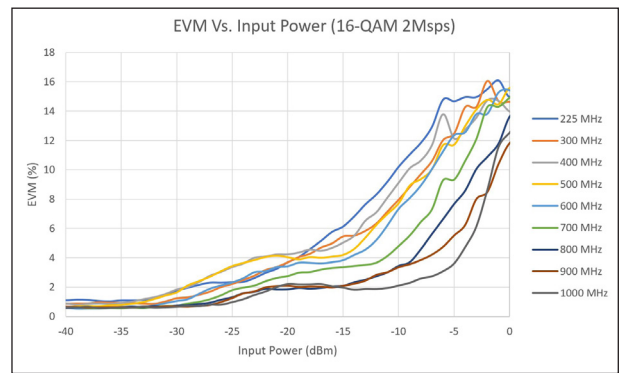

### EVM vs. Output Power (16-QAM 2Msps)

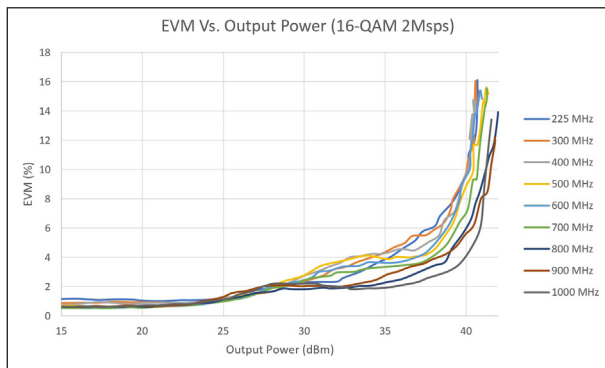

### EVM vs. Input Power (32-QAM 2Msps)

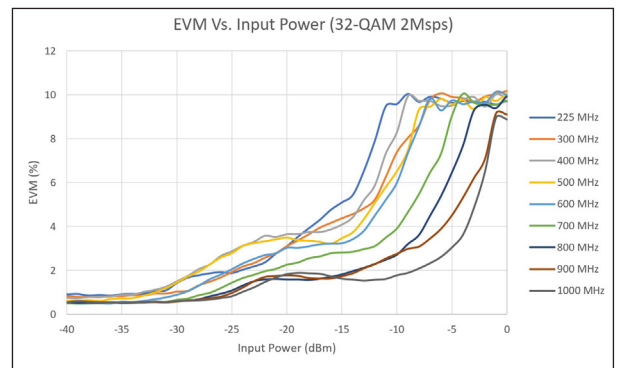

### EVM vs. Output Power (32-QAM 2Msps)

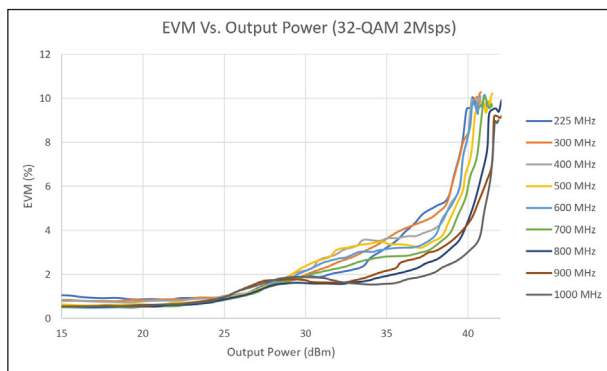

# NuPower™ U-20-C01-S01 Power Amplifier

## Mechanical Outline

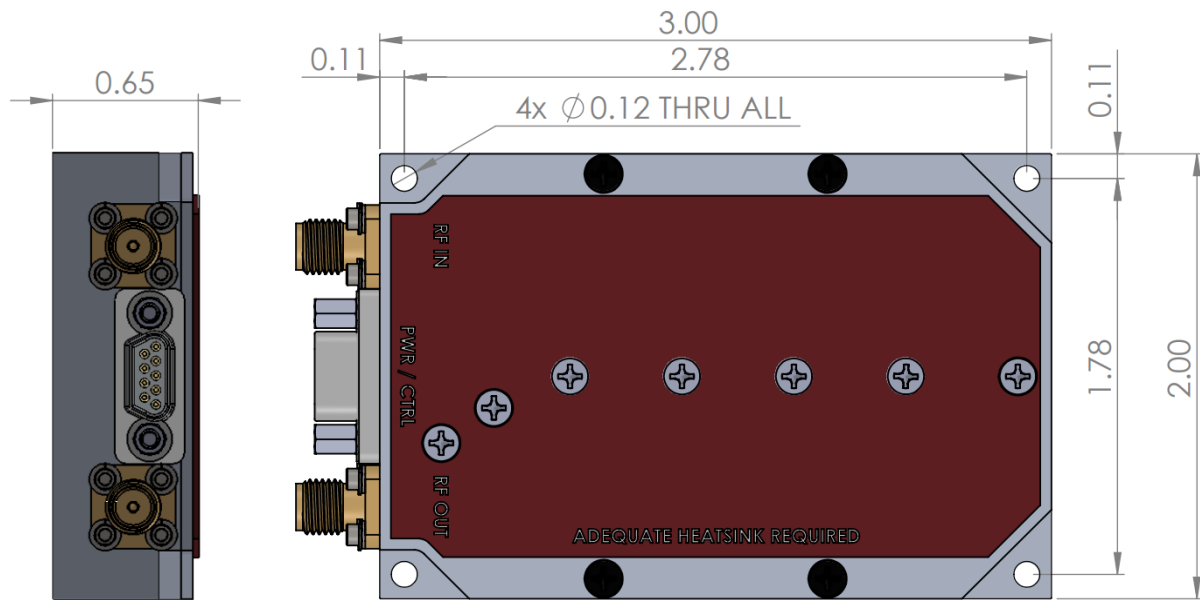

## Accessory Part Numbers

Part Number	Description
NW-FL-05LPLE-2500-SFSF-M01	Harmonic Filter Module
NW-PA-ACC-CB09MA	Standard Interface Cable Assembly - Flying Leads (included with module)
NW-PA-ACC-CT09MA	Upgraded Interface Cable Assembly - Banana Plug Termination
NW-PA-ACC-KT01	Accessory Kit, which includes Fan-Cooled Heatsink and Upgraded Interface Cable
NW-PA-ACC-HS01	Heatsink with Integrated Fan

For information on product disposal (end-of-life), please refer to this document:  
<https://nuwaves.com/wp-content/uploads/Product-Disposal-End-of-Life.pdf>

## Pinout

Function	I/O	Pin	Logic Voltage
DC Power (+11 to +32 VDC)	I	1, 2	–
Ground	I	3, 4	–
Over Temperature Flag 0V = temperature fault +5V = no fault	O	8	–
RF Enable 0V or GND = RF ON NC = RF OFF	I	5	0V to 1.5V = Logic Low 3.0V to +5V = Logic High <sup>1</sup>
No Connect	–	6, 7, 9	–

<sup>1</sup>RF Enable is pulled high internally and does not require user to apply voltage to this line

## Contact NuWaves



NuWaves RF Solutions  
 132 Edison Drive  
 Middletown, OH 45044

[www.nuwaves.com](http://www.nuwaves.com)  
[sales@nuwaves.com](mailto:sales@nuwaves.com)  
 513.360.0800

