



# Type 900X

## Miniature I/P, E/P Transducer for Electronic Air Pressure Control

Self-correcting to maintain precise control

Available with zero-based ranges

The Type-900X I/P, E/P transducer converts an electrical signal (current or voltage) to a proportional pneumatic output. Utilizing closed-loop pressure feedback circuitry, it provides precise, stable pressure outputs to final control elements. Immunity to vibration effects or mounting position, high tolerance to impure air, and low air consumption make this unit ideal for demanding applications. The compact housing, accessible ports and easy adjustments make it perfect for constrained spaces. An integral volume booster provides high flow capacity, increasing control speed in critical applications.

### Features

- **Electronic Closed-loop Feedback**  
Minimizes effects of vibration, mounting position, temperature and supply pressure
- **Compact Size** Great for high density mounting
- **Easy Wiring** Conduit, terminal block, M12 or DIN 43650 connections
- **Input/Output Ports on Front and Back**  
Provides flexible pneumatic connections
- **Other Features** Field selectable outputs (optional), field reversible, RFI/EMI protection, external orifice, supply pressures up to 130 psig
- **Intrinsic Safety Approvals**  
Standard feature for 4-20mA units:
  - Factory Mutual (FM),
  - Canadian Standards Assoc. (CSA)

Optional feature for 4-20mA units:

- ATEX



# Type 900X Durable, precise control from a variable signal

## Functional Specifications

	Standard Range					High Output Range				
<b>Inputs<sup>†</sup></b>	4-20 mA, 0-10VDC, 1-9 VDC, 0-5 VDC, 1-5 VDC									
<b>Outputs</b>	<b>psig (bar)</b>	1-17 (0.07-1.20)	3-15 (0.20-1.00)	3-27 (0.20-1.80)	6-30 (0.40-2.00)	0-15 (0.00-1.00)	0-30 (0.00-2.00)	2-60 (0.14-4.00)	2-100 (0.14-6.90)	0-60* (0.00-4.00)
<b>Supply Pressure</b>	<b>psig (bar)</b>	22-60 (1.50-4.0)	20-100 (1.40-6.90)	32-100 (2.20-6.90)	35-100 (2.40-6.90)	25-65 (1.72-4.50)	40-70 (2.75-4.82)	65-130 (4.50-9.00)	105-130 (7.20-9.00)	70-80 (4.82-5.50)
<b>Air Consumption*</b>	1.5 scfh (0.75 NI/min) at mid range typical							4.5 scfh (2.25 NI/min) at mid range typical		
<b>Flow Capacity</b>	4.5 scfm (127 NI/min) at 25 psig (1.7 bar) supply 12.0 scfm (340 NI/min) at 100 psig (7.0 bar) supply							20.0 scfm (566 NI/min) at 130 psig (9.0 bar) supply		
<b>Temperature Limits</b>	Operating -40° to +158° F (-40° to +70° C) Storage -40° to +200° F (-40° to +93° C)									
<b>Loop Load, I/P Transducer</b>	9.5 VDC @ 20 mA									
<b>Supply Voltage, E/P Transducer</b>	7-30 VDC, less than 3 mA									
<b>Signal Impedance E/P Transducer</b>	10 Kilohms									

<sup>†</sup>Extended periods of electrical input without supply air pressure may damage unit.

\*Zero-based units have slightly higher air consumption.

## Principles of Operation

The heart of this unique technology is a bimorph piezo actuator that is encapsulated in a protective skin. This provides a constant defense against humidity and contaminants often found in process operating environments. The Type-900X utilizes a nozzle to control a pilot pressure to an integral volume booster. The resultant output pressure is measured by a pressure sensor which in turn provides a feedback signal to the circuitry.

The feedback circuit compares this signal to the input signal and self corrects as necessary, thus minimizing the effects of variation in vibration, position, temperature, and supply pressure. The current/voltage signal flows to the piezo actuator causing the actuator to move toward a nozzle. This restricts the flow of air through the nozzle and creates back pressure in the nozzle which acts as a pilot pressure to an integral booster relay.

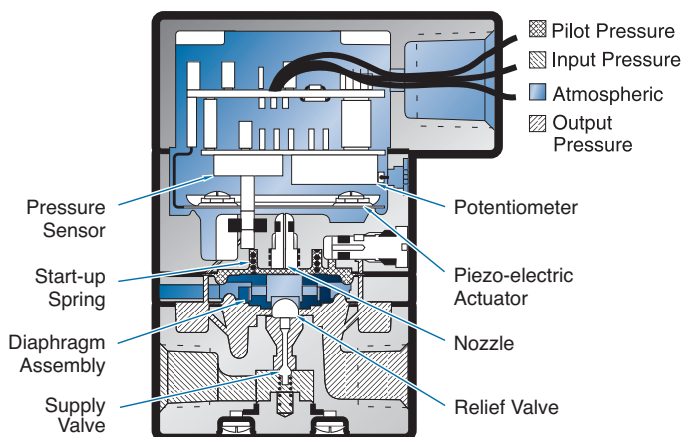

## Performance Specifications

<b>Accuracy, Hysteresis, and Repeatability</b>	±0.10% of span guaranteed
<b>Deadband</b>	.02% of span
<b>Position Effect</b>	No measurable effect
<b>Vibration Effect</b>	Less than ±1.0% of span under the following conditions: 5-15Hz @ 0.8 inches constant displacement; 15-500Hz @ 10g's
<b>Supply Pressure Effect</b>	No measurable effect
<b>Temperature Effect</b>	±0.045%/°F (0.07%/°C) of span
<b>Reverse Polarity Effect</b>	No damage from reversal of normal supply current (4-20 mA) or from misapplication of up to 60 mA
<b>RFI/EMI Effect</b>	Less than .5% of span change in output pressure per En 61000-4-3:1998, Amendment 1, Performance Criterion A

High accuracy  $\pm 0.10\%$  of span

NEMA-4X (IP65) enclosure

Intrinsic safety approvals

Optional field selectable outputs

Field reversible

Split range operation

Conduit, terminal block, M12 or DIN connector options

Wall, panel, pipe or DIN rail mounting

Vibration and position insensitive

Low air consumption for greater operating economy

Reliable in harsh environments

Compact size

Built-in volume booster

Supply pressure up to 130 psig

Input/output ports on front and back



## Applications

The Type 900X is used extensively by professionals who demand maximum performance and reliability when controlling valve actuators, pneumatic valve positioners, air cylinders, clutches, brakes, dampers, louvers, and pumps.

**Original equipment applications include:**

- Machinery for grinding or polishing
- Automated assembly, conveying, dispensing and web tensioning
- Semiconductor manufacturers
- Food processing
- HVAC, welding, leak testing and painting

## Physical Specifications

<b>Port Sizes</b>	Pneumatic	1/4" NPT
	Electric	1/2" NPT
<b>Media</b>	Clean, dry, oil-free, air-filtered to 40 micron	
<b>Mounting</b>	Wall, panel, 1.5" or 2" pipe (optional) or DIN rail (optional)	
<b>Enclosure</b>	NEMA 4X {IP-65} (conduit connection "A" only)	
<b>Materials</b>	Housing	Chromate-treated aluminum with epoxy paint. NEMA 4X (IP65)
	Elastomers	Buna-N
	Trim	Stainless steel; brass; zinc-plated steel
<b>Weight</b>	13.0 oz (0.4 kg)	

# Type 900X

## Standard Configurations

### Electrical Connections

#### 1/2 inch Conduit Connection (A)

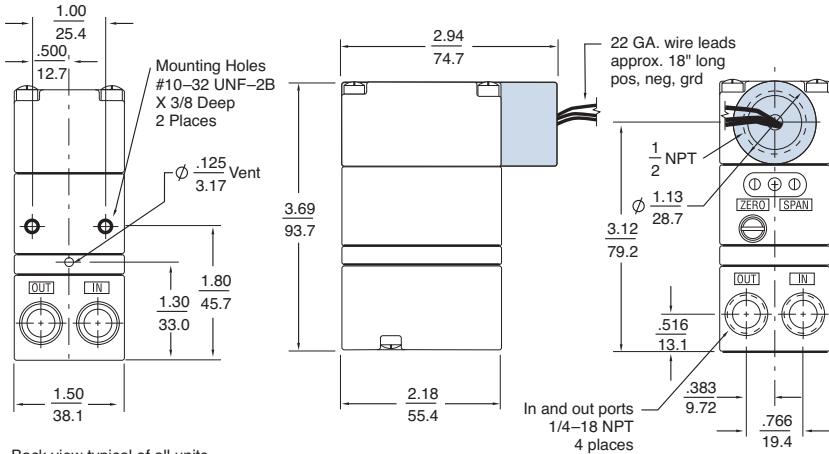

Back view typical of all units

## Options

#### Terminal Block (T)

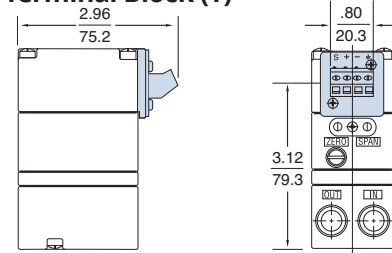

#### DIN 43650 Connector (D)

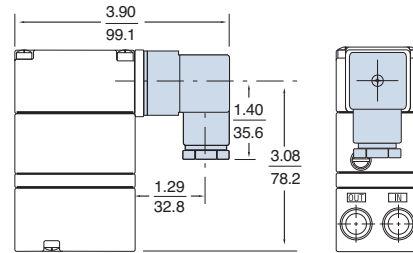

#### M12 Connector (M)

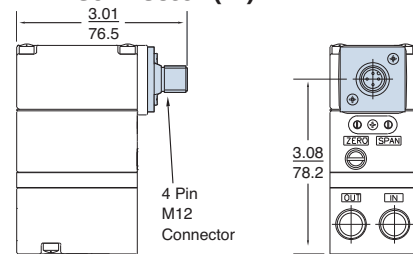

### Mounting Options

#### Pipe Mounting-1.5" or 2" Pipe

Order kit # 448-542-005

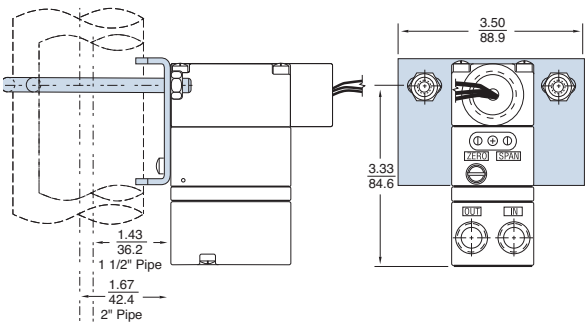

#### Panel Mounting

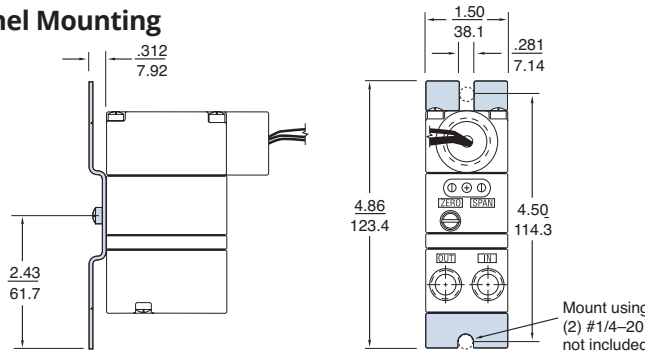

#### DIN Rail Mounting

Order kit # 445-766-024

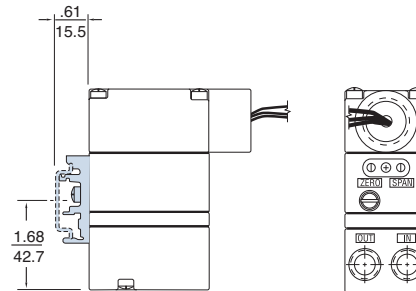

DIN Rail Kit suitable for EN-50035, EN-50045 and EN-50022 Rails

# Type 925 Multifunction Supply Manifold

A common supply port with individual shut off valves

## Dimensional Drawings

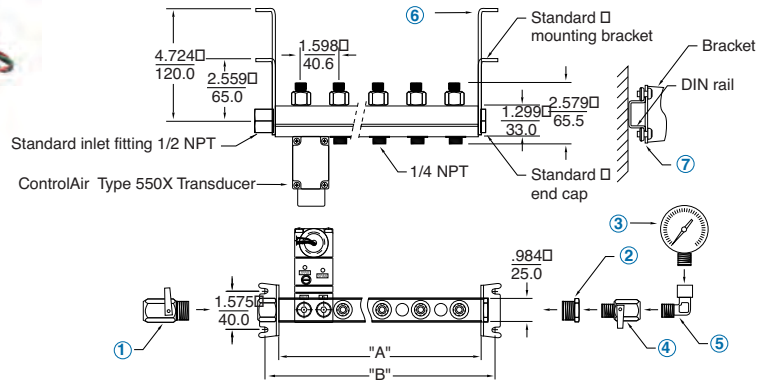

The Type 925 Multifunction Manifold provides a common air supply line to multiple units of our Type 550X and Type 900X I/P, E/P transducers.

Manifolds are available to hold 3, 5, 10 or 15 units. Each port features a patented individual shut-off valve that allows safe on-line service or modification with supply pressure on. Individual units may be installed or removed without effecting other units on the manifold. Construction of the manifold is simple and flexible. Connection ports thread easily into the I/P, E/P units.

No additional hardware such as check valves or adapter kits are required. The Type 925 is DIN rail mountable (optional). The Type 925 can also be used as a common output manifold for solenoid valves.

## Ordering

Stations	Length "A" in. (mm)	Length "B" in. (mm)
3	6.1 (155)	7.13 (181)
5	9.3 (236)	10.31 (262)
10	17.3 (439)	18.31 (465)
15	25.3 (642)	26.30 (668)

Type 925 Manifolds	Part Number
3 Unit Manifold Kit	438-544-005
5 Unit Manifold Kit	438-544-006
10 Unit Manifold Kit	438-544-007
15 Unit Manifold Kit	438-544-008

Each kit includes manifold, mounting brackets (2), end cap, 1/2" NPT inlet fitting

Diagram #	Accessories	Part Number
1	1/2" Supply Shut-off Valve	445-778-008
2	1/2" to 1/4" NPT Reducer	445-722-005
3	Pressure Gauge (1/4" bottom mount, 0-60 psig)	446-725-014
3	Pressure Gauge (1/4" bottom mount, 0-160 psig)	446-725-015
4	1/4" Shut-off Valve	445-778-009
5	1/4" Elbow	445-722-004
6	Extended Mounting Bracket Kit (Includes both brackets)	448-544-009
7	DIN Rail Mounting Kit	448-542-004

# Type 900X Miniature I/P, E/P Transducer for Electronic Air Pressure Control

## Performance Characteristics

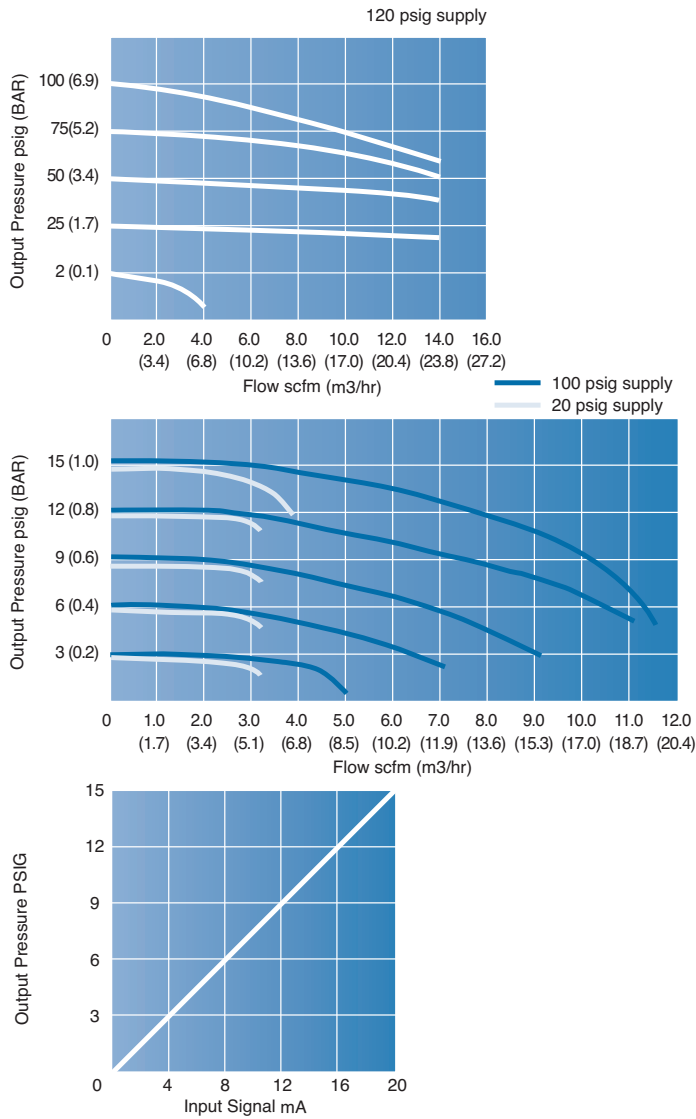

**Warranty** ControlAir, LLC products are warranted to be free from defects in materials and workmanship for a period of eighteen months from the date of sale, provided said products are used according to ControlAir, LLC recommended usages. ControlAir, LLC's liability is limited to the repair, purchase price refund, or replacement in kind, at ControlAir, LLC's sole option, of any products proved defective. ControlAir, LLC reserves the right to discontinue manufacture of any products or change products materials, designs or specifications without notice. Note: ControlAir does not assume responsibility for the selection, use, or maintenance of any product. Responsibility for the proper selection, use, and maintenance of any ControlAir product remains solely with the purchaser and end user. Drawing downloads available at [www.controlair.com](http://www.controlair.com).

## Ordering Use this coding system to order

**Model**  
**900**

**Input Signal**

- A 4-20 mA
- C 0-5 VDC
- D 1-9 VDC
- E 0-10 VDC
- F 1-5 VDC

**Options**

- A Field selectable outputs\* (0.20% accuracy)
- K ATEX Approvals (4-20mA only)
- U 1/4" BSP Porting

**Electrical Connection**

Output	psig	bar
C	3-15	0.20-1.0
D	3-27	0.20-1.8
E	6-30	0.40-2.0
F	1-17	0.07-1.2
G	2-60	0.13-4.1
H	2-100	0.13-6.9
L	0-15	0.00-1.0
I	0-30	0.00-2.1
J	0-60	0.00-4.1

**Electrical Connection**

- A 1/2" NPT conduit with pigtail
- D DIN 43650 connector
- M M12 Connector (No agency approvals)
- T Terminal Block

## Accessories

DIN Rail Mounting Kit Kit # 445-766-024

1.5" or 2" Pipe Mounting Kit Kit # 448-542-005

\*Field selectable option is available only for units with the following outputs: 3-15 psig, 3-27 psig, 6-30 psig.

## Hazardous Area Classification

**Factory Mutual (FM) & Canadian Standards (CSA) Approvals**  
Standard feature for 4-20mA units

### Intrinsically Safe (1/2" NPT Conduit)

Class I, II, III, Division 1,  
Groups C, D, E, F, & G  
Enclosure Nema 4X(IP 65)  
Temp. Code T4 Ta = 70° C  
Rated 4-20 mA, 30 VDC Max.

### Intrinsically Safe (DIN & Terminal)

Class I, Division 1, Groups C & D  
Temp. Code T4 Ta = 70° C  
Rated 4-20 mA, 30 VDC Max.

### Entity Parameters (conduit)

Ui (Vmax) = 30 VDC Ci = 0 uF  
Ii (Imax) = 125 mA Li = 0 mH  
Pi = .7 w Max.

### ATEX Approvals (option K)

Ex ia IIB T4  
Tamb = -40° C to +70° C  
FM08ATEX0048X

### Non-Incendive (Conduit, DIN, Terminal)

Class I, Division 2,  
Groups A, B, C & D  
Temp. Code T4 Ta = 70° C

### Suitable for (Conduit only)

Class II & III, Division 2,  
Groups F & G  
Temp. Code T4 Ta = 70° C

### Entity Parameters (DIN and Terminal)

Ui (Vmax) = 30 VDC Ci = .03 uF  
Ii (Imax) = 125 mA Li = 0 mH  
Pi = .7 w Max.

### Entity Parameters

U: (Vmax) = 30 VDC Ci = 1 uF  
I: (Imax) = 125 mA Li = 2.2 mH  
Pi = .7 W Max.



8 Columbia Drive / Amherst, NH 03031 USA / [www.controlair.com](http://www.controlair.com) / [sales@controlair.com](mailto:sales@controlair.com) / 603-886-9400 / FAX 603-889-1844

An ISO 9001:2015 Registered Company

P/N 441-625-014 10/2/20