



# **TFT LCD Module**

## **Product Specification**

**DT024DTFT**  
**2.4" (240RGB x 320 DOTS) TFT Module**

May 6, 2016

**Remark:**

Contents in this document are subject to change without notice. No part of this document may be reproduced or transmitted in any form or by any means, electronic or mechanical, for any purpose, without the express written permission of Displaytech Ltd.

**Displaytech Ltd.**

Tel: (852) 2311 2080 ; Fax: (852) 2722 6998 ; Email: [sales@displaytech.com.hk](mailto:sales@displaytech.com.hk)

Address: 31E Billion Plaza 2, No. 10 Cheung Yue Street, Cheung Sha Wan, Kowloon,  
Hong Kong.

Website: <http://www.displaytech.com.hk>

### Revision Record

<b>REV</b>	<b>CHANGES</b>	<b>DATE</b>
0.0 (Ref 1.0 20160415)	First release	May 6, 2016

## Table of Content

<b>Revision Record .....</b>	<b>1</b>
<b>1. Scope.....</b>	<b>3</b>
<b>2. Application .....</b>	<b>3</b>
<b>3. General Information .....</b>	<b>3</b>
<b>4. Outline Drawing .....</b>	<b>4</b>
<b>5. Interface Signals .....</b>	<b>5</b>
<b>6. Absolute Maximum Ratings .....</b>	<b>5</b>
<b>7. Electrical Specifications .....</b>	<b>6</b>
<b>8. Optical Specification.....</b>	<b>6</b>
<b>9. Environmental / Reliability Tests .....</b>	<b>9</b>
<b>10. Precautions for Use of LCD Modules .....</b>	<b>9</b>

## 1. Scope

This data sheet is to introduce the specification of DT024DTFT, active matrix TFT module. It is composed of a color TFT-LCD panel, driver ICs, FPC and a backlight unit. The 2.40" display area contains 240(RGB) x 320 pixels.

## 2. Application

Digital equipment which need color display, mobile phone, mobile navigator/video systems.

## 3. General Information

Item	Contents	Unit
Size	2.4	Inch
Resolution	240(RGB) x 320	
Technology Type	IPS TFT	
Interface	RGB/MCU	
Pixel Configuration	R.G.B. Vertical Stripe	
Outline Dimension (W x H x D)	42.72 x 59.46 x 2.20	mm
Active Area	36.72 x 48.96	mm
Display Mode	Transmissive/ Normally Black	
Backlight Type	LED	
Driver IC	ILI9341V	
Weight	TBD	g

### 4. Outline Drawing

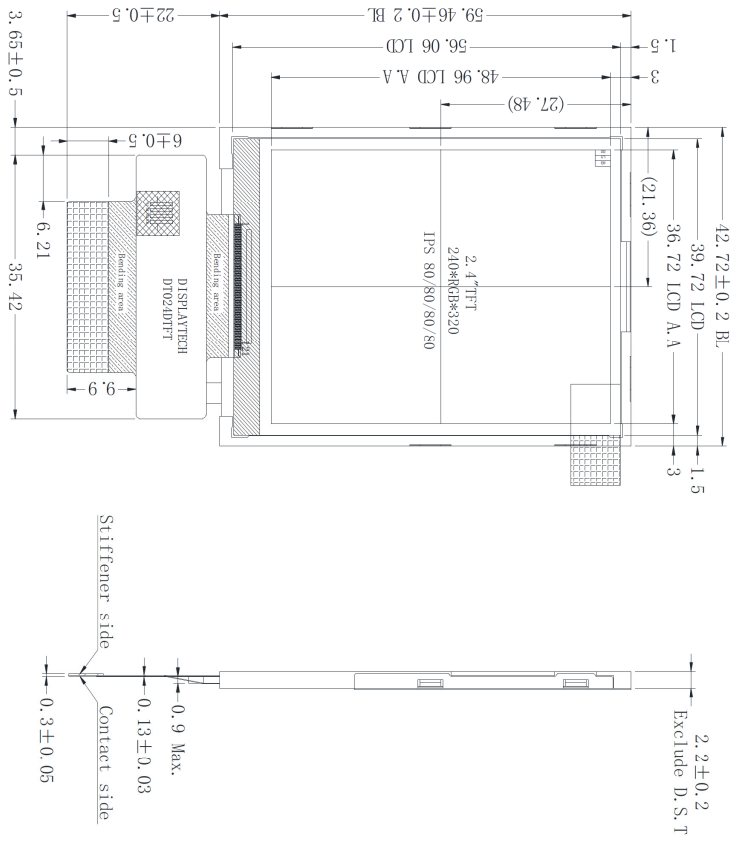

**NOTES:**

1. DISPLAY TYPE: 2.4 TFT, NORMALLY BLACK
2. VIEWING DIRECTION : U/L/D/R 80/80/80/80
3. Driver IC : ILI9341V
4. Top : -20° C ~ 70° C, Tst : -30° C ~ 80° C
5. POLARIZER: Glossy finish
6. GENERAL TOLERANCE: ±0.2
7. LCM Luminance: LED/220cd/m<sup>2</sup> (Typical)
8. LED LIFETIME: 50KHRS
9. RoHS Compliant

4EA If=15mA Vf=12.0v (typ.)

LED CIRCUIT DIAGRAM:

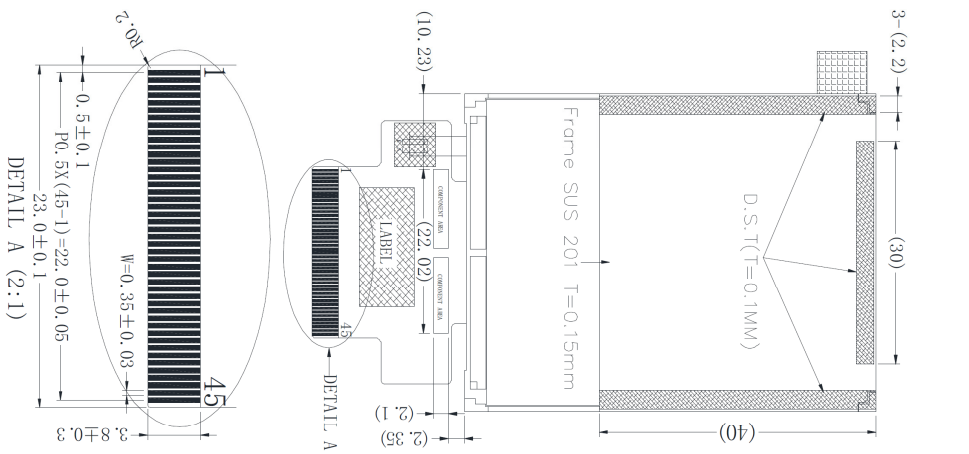

1	NC
2	IM0
3	IM1
4	IM2
5	IM3
6	RESET
7	VSYNC
8	HSYNC
9	DOTCLK
10	ENABLE
11	DB17
12	DB16
13	DB15
14	DB14
15	DB13
16	DB12
17	DB11
18	DB10
19	DB9
20	DB8
21	DB7
22	DB5
23	DB5
24	DB4
25	DB3
26	DB2
27	DB1
28	DB0
29	S/D1
30	S/D1
31	RD
32	RS/SCL
33	WR
34	CS
35	FMARK
36	VCC
37	VCC
38	GND
39	GND
40	LED A
41	LED K
42	NC(XR)
43	NC(YD)
44	NC(XL)
45	NC(YU)

# Displaytech Ltd.

DRAWN BY:	TITLE: DT024DTFT	SCALE:	UNIT: mm
CHECKED BY:	DWG NO:	DWG NAME:	SHEET NO: 0P
APPROVED BY:			
CONFIRMED BY:			

## 5. Interface Signals

No	Symbol	Description	
1	NC	No connection	
2	IM0	System interface select	
3	IM1		
4	IM2		
5	IM3		
6	RESET	System reset	
7	VSYNC	Frame sync signal	
8	HSYNC	Line sync signal	
9	DOTCLK	Data clock	
10	ENABLE	Data enable pin	
11 ~ 28	DB17 ~ DB0	Data bus	
29	SDO	Serial data output in serial bus system interface	
30	SDI	Serial data Input in serial bus system interface	
31	RD	Read enable pin I80 parallel bus system interface	
32	RS/SCL	DNC: Command / parameter or display data selection pin SCL: Serial data clock in serial bus system	
33	WR	Write Enable	
34	CS	Chip select signal	
35	FMARK	Tearing effect output pin to synchronize MPU to frame writing	
36	VCC	Power supply	
37	VCC	Power supply	
38	GND	Ground	
39	GND	Ground	
40	LEDA	LED backlight (Anode)	
41	LEDK	LED backlight (Cathode)	
42 ~ 45	NC	No connection	

## 6. Absolute Maximum Ratings

### 6.1 Electrical Absolute Max. Ratings

Item	Symbol	Min	Max	Unit	Remark
Power supply voltage	VCC	-0.3	3.6	V	

Notes:

- If the module is above these absolute maximum ratings. It may become permanently damaged. Using the module within the following electrical characteristic conditions are also exceeded, the module will malfunction and cause poor reliability.
- VCC > VSS must be maintained.

### 6.2 Environment Conditions

Item	Symbol	Min	Max	Unit	Remark
Operating Temperature	TOPR	-20	70	°C	
Storage Temperature	TSTG	-30	80	°C	

Note:

- The response time will become lower when operated at low temperature.
- Background color changes slightly depending on ambient temperature.  
The phenomenon is reversible.
- Ta ≤ 40°C : 85%RH MAX.  
Ta > 40°C : Absolute humidity must be lower than the humidity of 85%RH at 40°C.

## 7. Electrical Specifications

### 7.1 Electrical Characteristics

GND=0V, Ta=25°C

Parameter	Symbol	Condition	Min	Typ	Max	Unit	Note
Power supply	VCC	Ta=25°C	2.6	2.8	3.3	V	
Input voltage	“H”	VIH	VCC=2.8V	0.8VCC	-	VCC	V
	“L”	VIL	VCC=2.8V	0	-	0.2VCC	V
Current consumption	ICC1	Normal mode	-	7	12	mA	1
	ICC2	Sleep mode	-	0.05	0.1	mA	1

Note: 1. Tested in 1×1 chessboard pattern.

### 7.2 LED Backlight

Ta=25°C

Parameter	Symbol	Min	Typ	Max	Unit	Remarks
Forward current	VF	-	15	-	mA	
Forward voltage	IF	-	12	-	V	
LED life time	-	-	50,000	-	Hr	Note 2

Note: 2. The “LED life time” is defined as the module brightness decrease to 50% original brightness at Ta=25°C and IL =15mA. The LED lifetime could be decreased if operating IL is larger than15mA.

## 8. Optical Specification

Ta=25°C

Item	Symbol	Condition	Min	Typ	Max	Unit	Remark
Contrast Ratio	CR	$\theta=0^\circ$	300	500	-		Note 1 Note 2
Response Time	Tr	25°C	-	10	-	ms	Note 1
	Tf		-	10	-	ms	Note 3
View Angles	$\theta T$	CR $\geq$ 10	-	80	-	Degree	Note 4
	$\theta B$		-	80	-		
	$\theta L$		-	80	-		
	$\theta R$		-	80	-		
Chromaticity	White	X	-	0.28	-		Note 1 Note 5
		Y	-	0.33	-		
	Red	X	-	0.51	-		
		Y	Brightness is on	-	0.34		
	Green	X	-	0.31	-		
		Y	-	0.56	-		
Blue	X	-	0.15	-			
	Y	-	0.14	-			
NTSC	S		50	60	-	%	Note 5
Luminance	L		170	220	-	cd/m <sup>2</sup>	Note 1 Note 6
Uniformity	U		-	80	-	%	Note 1 Note 7

Note 1: Definition of optical measurement system.

Temperature = 25°C(±3°C)

LED back-light: ON, Environment brightness < 150 lx

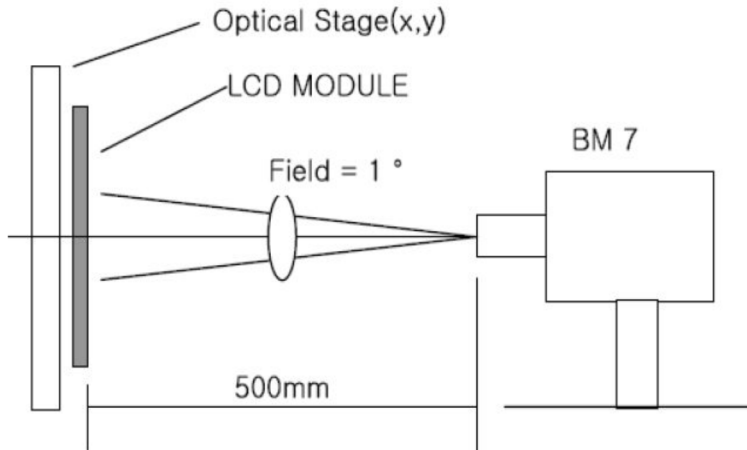

Note 2: Contrast ratio is defined as follow:

$$\text{Contrast Ratio} = \frac{\text{Surface Luminance with all white pixels}}{\text{Surface Luminance with all black pixels}}$$

Note 3: Response time is defined as follow:

Response time is the time required for the display to transition from black to white (Rise Time,  $T_r$ ) and from white to black(Decay Time,  $T_f$ ).

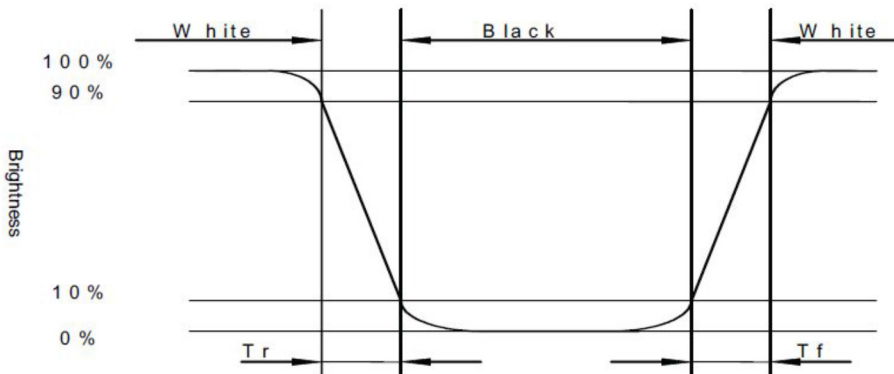

Note 4: Viewing angle range is defined as follow:

Viewing angle is measured at the center point of the LCD.

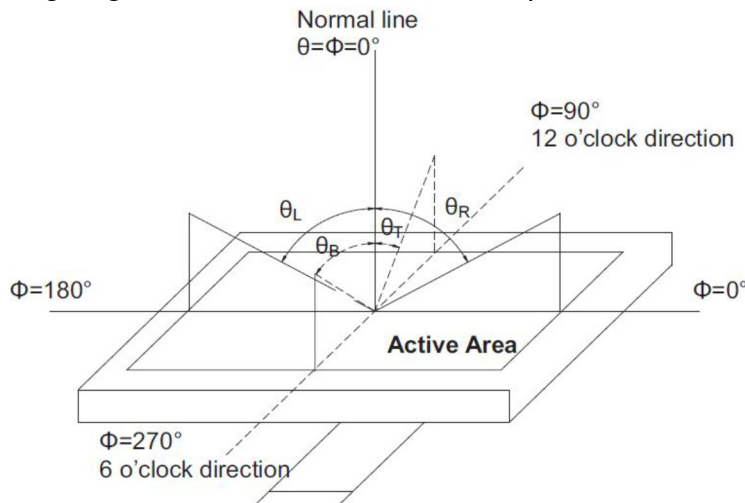



Note 5: Color chromaticity is defined as follow: (CIE1931)  
 Color coordinates measured at center point of LCD.

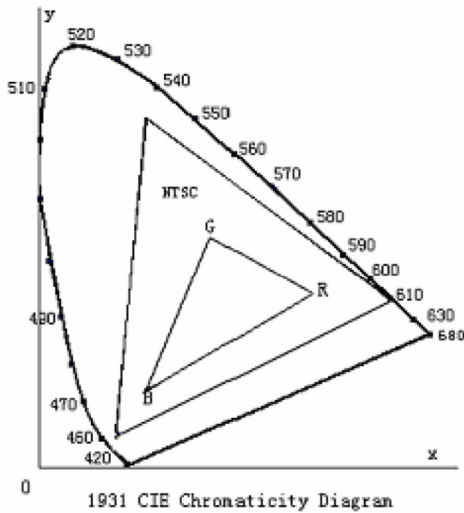

$$S = \frac{\text{area of RGB triangle}}{\text{area of NTSC triangle}} \times 100\%$$

Note 6: Luminance is defined as follow:

Luminance is defined as the brightness of all pixels “White” at the center of display area on optimum contrast.

Note 7: Luminance Uniformity is defined as follow:

Active area is divided into 9 measuring areas (Refer Fig. 2). Every measuring point is placed at the center of each measuring area.

$$\text{Uniformity (U)} = \frac{\text{Minimum Luminance( brightness ) in 9 points}}{\text{Maximum Luminance( brightness ) in 9 points}}$$

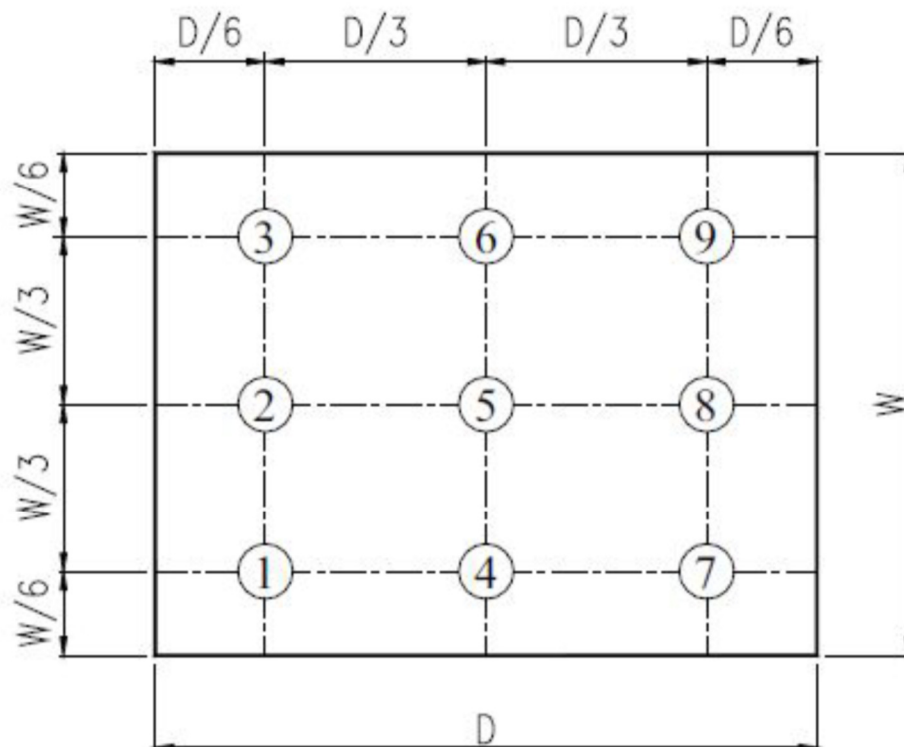

Fig. 2 Definition of uniformity

## 9. Environmental / Reliability Tests

No	Test Item	Condition	Judgment Criteria
1	High Temp Operation	Ts=+70°C, 96hrs	Per table in below
2	Low Temp Operation	Ta=-20°C, 96hrs	Per table in below
3	High Temp Storage	Ta=+80°C, 96hrs	Per table in below
4	Low Temp Storage	Ta=-30°C, 96hrs	Per table in below
5	High Temp & High Humidity Storage	Ta=+60°C, 90% RH 96 hours	Per table in below (polarizer discoloration is excluded)
6	Thermal Shock (Non-operation)	-30°C 30 min~+80°C 30 min, Change time: 5min, 5 Cycles	Per table in below
7	ESD (Operation)	C=150pF, R=330Ω, 5points/panel Air:±8KV, 5times; Contact:±4KV, 5 times;	Per table in below
8	Vibration (Non-operation)	10Hz~150Hz, 100m/s <sup>2</sup> , 120min	Per table in below
9	Shock (Non-operation)	Half- sine wave,300m/s <sup>2</sup> ,11 ms	Per table in below
10	Package Drop Test	Height: 80 cm, 1 corner, 3 edges, 6 surfaces	Per table in below

Inspection	Criterion (after test)
Appearance	No Crack on the FPC, on the LCD Panel
Alignment of LCD Panel	No Bubbles in the LCD Panel No other Defects of Alignment in Active area
Electrical current	Within device specifications
Function / Display	No Broken Circuit, No Short Circuit or No Black line No Other Defects of Display

## 10. Precautions for Use of LCD Modules

### 10.1 Safety

The liquid crystal in the LCD is poisonous. Do not put it in your mouth. If the liquid crystal touches your skin or clothes, wash it off immediately using soap and water.

### 10.2 Handling

- A. The LCD and touch panel is made of plate glass. Do not subject the panel to mechanical shock or to excessive force on its surface.
- B. Do not handle the product by holding the flexible pattern portion in order to assure the Reliability
- C. Transparency is an important factor for the touch panel. Please wear clear finger sacks, gloves and mask to protect the touch panel from finger print or stain and also hold the portion outside the view area when handling the touch panel.
- D. Provide a space so that the panel does not come into contact with other components.
- E. To protect the product from external force, put a covering lens (acrylic board or similar board) and keep an appropriate gap between them.

- F. Transparent electrodes may be disconnected if the panel is used under environmental conditions where dew condensation occurs.
- G. Property of semiconductor devices may be affected when they are exposed to light, possibly resulting in IC malfunctions.
- H. To prevent such IC malfunctions, your design and mounting layout shall be done in the way that the IC is not exposed to light in actual use.

### 10.3 Static Electricity

- A. Ground soldering iron tips, tools and testers when they are in operation.
- B. Ground your body when handling the products.
- C. Power on the LCD module before applying the voltage to the input terminals.
- D. Do not apply voltage which exceeds the absolute maximum rating.
- E. Store the products in an anti-electrostatic bag or container.

### 10.4 Storage

- A. Store the products in a dark place at  $+25^{\circ}\text{C}\pm 10^{\circ}\text{C}$  with low humidity (40% RH to 60% RH). Don't expose to sunlight or fluorescent light.
- B. Storage in a clean environment, free from dust, active gas, and solvent.

### 10.5 Cleaning

- A. Do not wipe the touch panel with dry cloth, as it may cause scratch.
- B. Wipe off the stain on the product by using soft cloth moistened with ethanol. Do not allow ethanol to get in between the upper film and the bottom glass. It may cause peeling issue or defective operation. Do not use any organic solvent or detergent other than ethanol.

### 10.6 Cautions for installing and assembling

Bezel edge must be positioned in the area between the Active area and View area. The bezel may press the touch screen and cause activation if the edge touches the active area. A gap of approximately 0.5mm is needed between the bezel and the top electrode. It may cause unexpected activation if the gap is too narrow. There is a tolerance of 0.2 to 0.3mm for the outside dimensions of the touch panel and tail. A gap must be made to absorb the tolerance in the case and connector.

