

**STINGRAY** | Magnetic Connector Series



# STINGRAY

## Magnetic Connector Series

**This series offers low profile, compact, sealed connectors that withstand exposure to rain, dust, dirt and chemicals. Stingray connectors are intended for First Responders, Security and Military personnel.**

Stingray features a magnetic, non-keyed mating system which allows the connector to be easily mated without the need for pre-alignment and eliminates the need to operate any coupling mechanisms.

Stingray has been optimised for USB 2.0 & Ethernet protocols, and is an excellent solution for audio, power or data signals.

The low profile Stingray connector sits flat against the body to prevent snagging & damage. It is self-aligning due to the strong magnetic connection, and allows customisation and flexibility of cable routing as the cable can be rotated through 360° when the connector is mated.

Features	Benefits
Magnetic mating mechanism	Aids blind-mate performance and prevents inadvertent damage if the user forgets to unmate
Non-keyed rotatable mating	Does not require pre-alignment when mating. Cable exit angle is infinitely variable and can be set and adjusted by the user
Wipe clean interface featuring sprung-loaded contacts	Easy cleaning and decontamination
5000+ mating cycles	Increased connector life before replacement
Compatible with USB 2.0, Ethernet and Audio signal requirements	Allows interconnection of various equipment including computers, radios and headsets
Last mate contact	Allows hot-swapping of equipment and signals (i.e. interface is passive until the connector is fully mated)
90° Cable exit within the height of the connector	Cable runs parallel to the body eliminating loops and preventing snagging
IP68 sealed	High degree of sealing prevents ingress of dust and moisture



## Stingray features and terminology

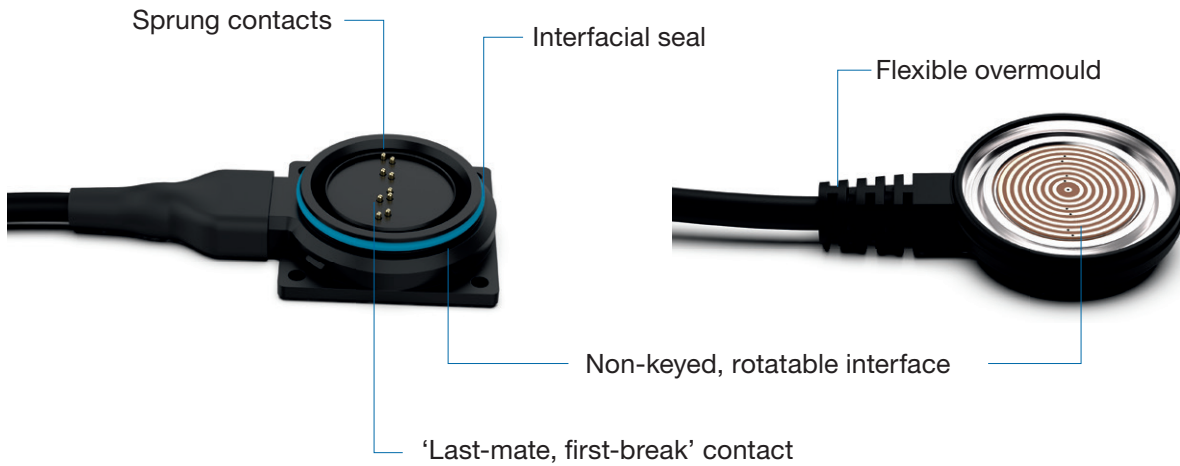

### Views of the mated pair



## Stingray performance information

Test parameter	Description
<b>Electrical</b>	
Current rating	3A per contact continuous, 5A per contact peak
Data rate	USB 2.0 compliant
Insulation resistance	5000 MΩ at 500 VDC
Contact resistance	<20 mΩ
<b>Environmental</b>	
Sealing	IP68, 1hr at 2 meters immersion
Operating temperature range	-55°C/+85°C
Storage temperature range	-55°C/+125°C
Salt spray	500 hours, 5% NaCl (mated)
RoHS compliant	Yes (dependent on solder used)
<b>Mechanical</b>	
Mating durability	5000 minimum
Shock and vibration	In accordance with DEF-STAN 00-35 Iss 4 Ch2 01 test M1 appendix A figs A22-High Level and A23-Low Level
Separation force, peel	4.0N typical
Rotations	1000 minimum
Rotational torque	0.7Nm typical



## Stingray connector part numbering

WM-	XX	XX	XX-	XX-	XXX
<b>Series identifier</b>	<b>Style:</b> 00 = Wall mount receptacle 01 = In-line receptacle 02 = PCB mount receptacle 06 = Plug	<b>Material and finish</b> AU - unplated black thermoplastic	<b>Shell size</b> 03	<b>No. of contacts</b> 09	<b>Variant (omitted for standard item)</b> Consult factory for more details

Please note:  
The unplated wall mount receptacle in shell size 3 with 9 contacts is currently available.  
The plug connector is only currently available as an overmoulded cable harness.  
Further variants are available to order from December 2018.

## Stingray part number example

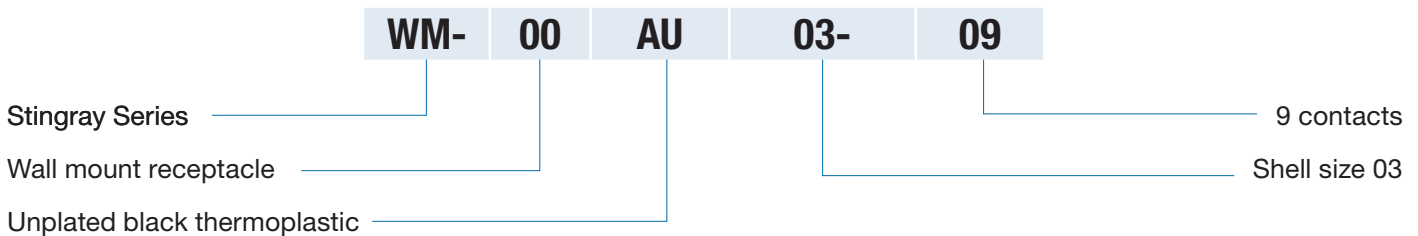

## Stingray cable harness part numbering

20GB-WM-	XX	XX	XX-	XX-	XXXX-	XXXX
<b>Series identifier</b>	<b>Style:</b> 00 = Wall mount receptacle 02 = In-line receptacle 06 = Plug	<b>Material and finish:</b> AU - Unplated Black Thermoplastic	<b>Shell size:</b> 03	<b>No. of contacts:</b> 09	<b>Length (mm):</b>	<b>Variant:</b> 0001 = Pig-tail assembly 0002 = Plug to Plug

Please note:  
Both the -0001 and -0002 variants use USB 3.0 SuperSpeed cable with high quality improved shielding.  
The cable is UL20276, OD:5.5mm with black PVC jacket.

## Stingray cable harness part number example

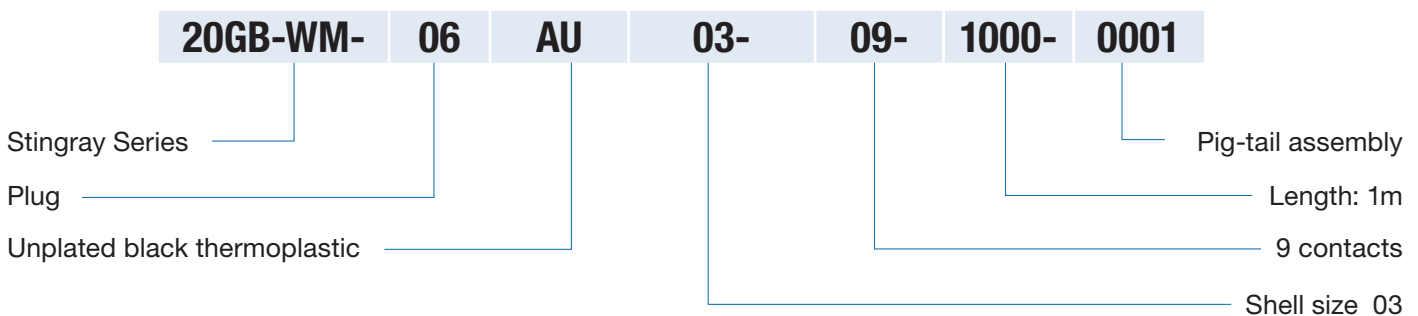

## Stingray plug assembly

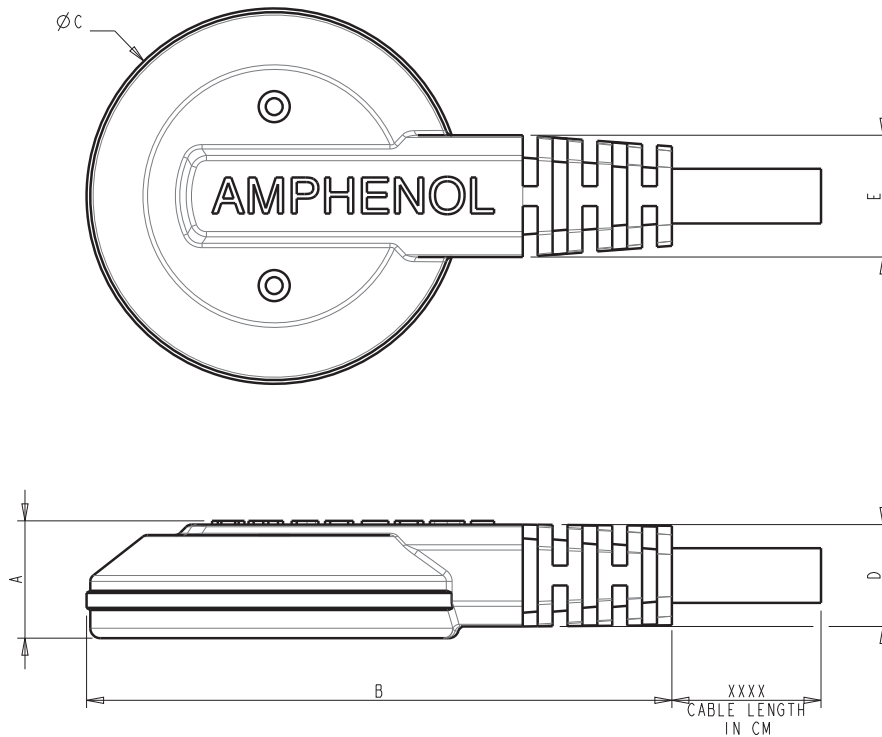

Shell size	A Nom		B Nom		$\varnothing C$ Nom		D Nom		E Nom	
	mm	inch	mm	inch	mm	inch	mm	inch	mm	inch
3	11.99	0.472	59.82	2.355	38.35	1.510	10.41	0.410	12.45	0.490

Please note:  
The plug is currently only available as an overmoulded cable harness.  
A customer terminated plug is available to order from December 2018.

## Stingray plug wiring schematic

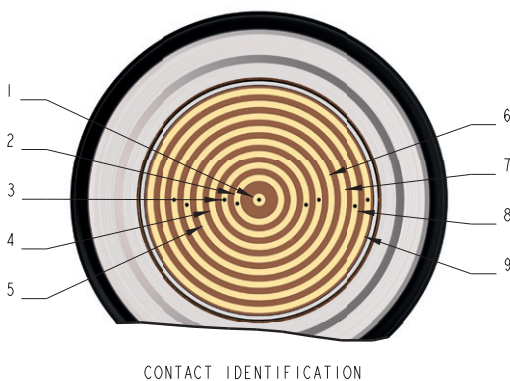

Contact number	USB identification	USB 2.0 connection	Cable colour
1	Power	Yes	Red
2	D-	Yes	White
3	D+	Yes	Green
4	SDP1-	No	Blue
5	SDP1+	No	Yellow
6	SDP2-	No	Purple
7	SDP2+	No	Orange
8	Power GND	Yes	Black
9	GND drain	Yes	Drain

## Stingray receptacle

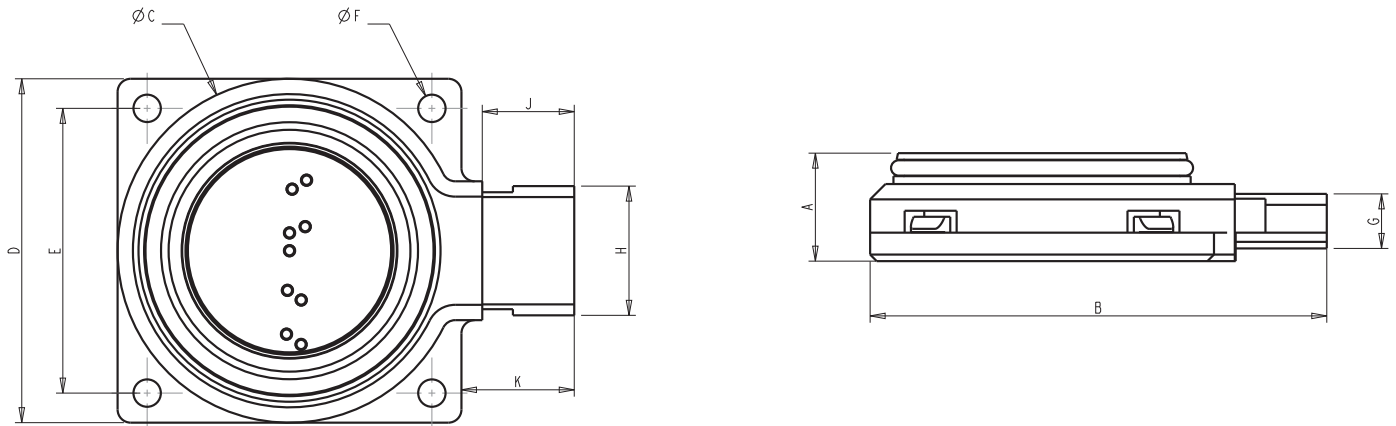

Shell size	A Nom		B Nom		$\varnothing C$ Nom		D Nom		E Nom	
	mm	inch	mm	inch	mm	inch	mm	inch	mm	inch
3	12.52	0.493	52.96	2.085	39.88	1.570	39.88	1.570	33.02	1.300
	$\varnothing F$ Nom		G Nom		H Nom		J Nom		K Nom	
	mm	inch	mm	inch	mm	inch	mm	inch	mm	inch
	3.18	0.125	6.32	0.249	14.99	0.590	10.67	0.420	13.08	0.515

Please note:  
An alternative PCB mount receptacle (WM-02) is available to order from December 2018

## Stingray receptacle wiring schematic

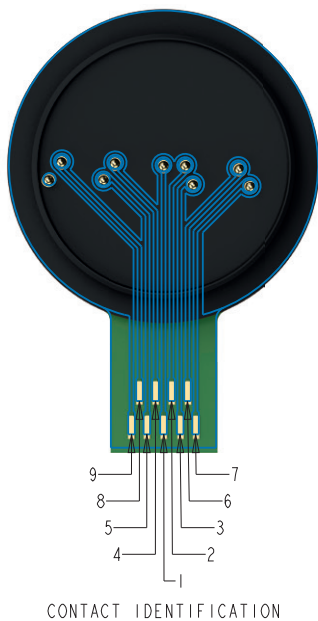

Contact number	USB identification	USB 2.0 connection
1	Power	Yes
2	D-	Yes
3	D+	Yes
4	SDP1-	No
5	SDP1+	No
6	SDP2-	No
7	SDP2+	No
8	Power GND	Yes
9	GND drain	Yes

## Stingray receptacle assembly instructions

General assembly instructions are shown below for the Stingray receptacle connector. The receptacle is supplied as three components ready for termination as shown below:

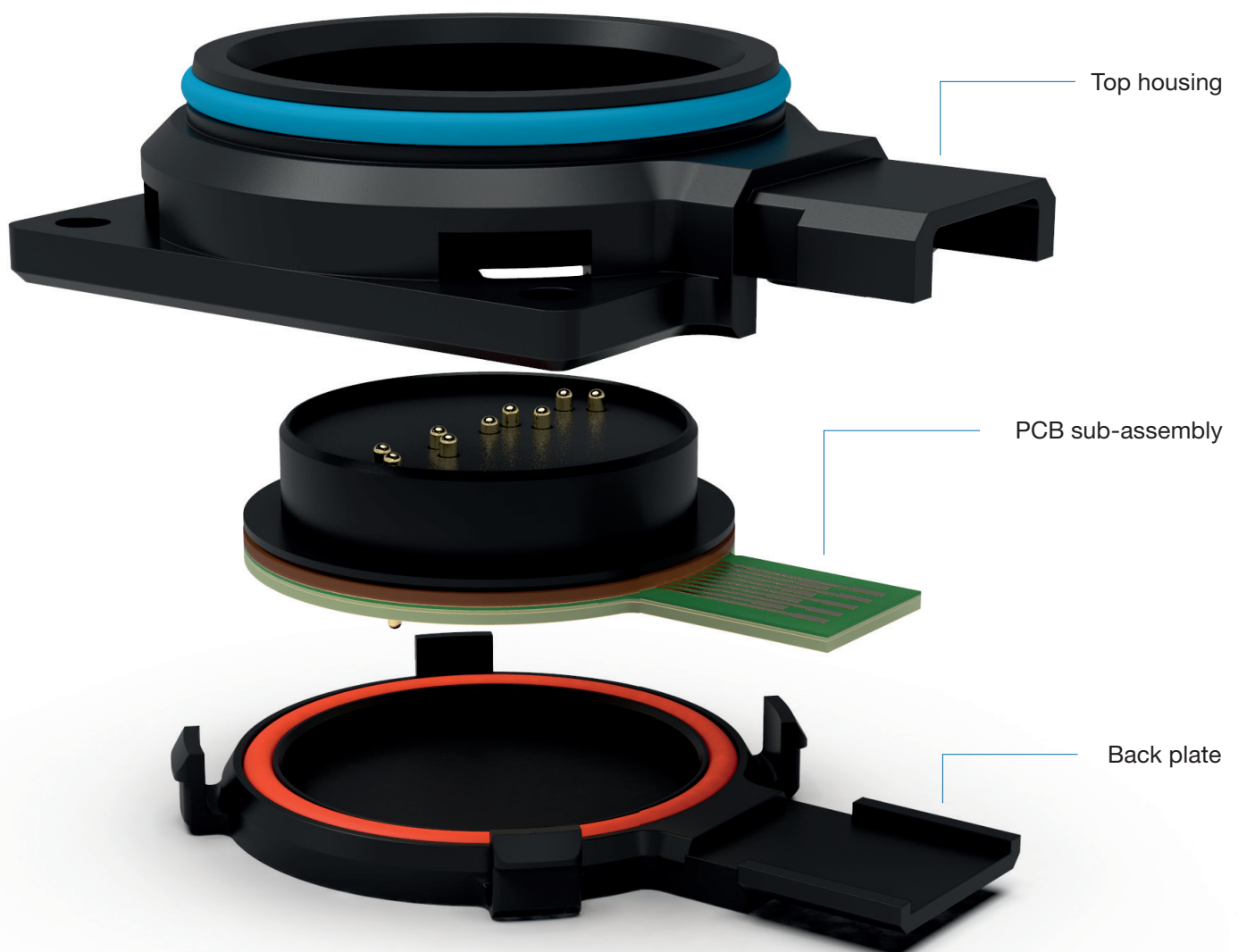

1. Terminate the cable to the PCB sub-assembly in accordance with Amphenol document 123GB-0879.
2. Lightly press the terminated PCB sub-assembly into the top housing.
3. Locate the back plate into the top housing (trapping the terminated PCB sub-assembly) and evenly apply pressure from the rear so that the clips fully engage and 'snap' into position.

Please note that ancillary components have been deleted from the above image for clarity.

# Worldwide sales contacts

## Europe

---

**Amphenol Ltd, UK**  
Thanet Way, Whitstable  
Kent, CT5 3JF  
United Kingdom  
T: +44 1227 773 200

**Amphenol Socapex, France**  
948, promenade de l'Arve BP29  
74311 Thyez Cedex  
France  
T: +33 4 50 89 28 00

**Amphenol Air LB, France**  
10 rue champ Raymond  
08110 Carignan  
France  
T: +33 3 24 22 32 70

**Amphenol AIR LB GmbH, Germany**  
Am Kleinbahnhof 4  
66740 Saarlouis  
Germany  
T: +49 6831 981 00

**Amphenol Nordic**  
T: +46 (0)702 3800104

**Amphenol Switzerland and South Centre**  
*Switzerland, Slovenia, Serbia, Montenegro, Yugoslavia, Greece, Bulgaria*  
948, promenade de l'Arve BP29  
74311 Thyez Cedex  
France  
T: +33 4 50 89 28 00

**Amphenol Italy**  
Via Barbaiana n.5  
20020 Lainate, Milano  
Italy  
T: +39 293 254 214

**Amphenol Benelux**  
Zadelmaker 121 NL  
2401 PD Alphen aan den Rijn  
The Netherlands  
T: +31 172 444 903

**Amphenol Iberica**  
Edificio Burgosol, Oficina nr 55  
Comunidad de Madrid,  
35 bis Las Rozas (Madrid)  
Spain  
T: +34 91 640 73 06

**Amphenol Poland and Central East Europe**  
*Austria, Poland, Czech Republic, Slovakia, Romania*  
Wiener gasse 68  
2380 Perchtoldsdorf  
Austria  
T: +43 699 10396 071

## North America

---

**Amphenol PCD USA**  
72 Cherry Hill Drive  
Beverly, MA. 01915-1065  
USA  
T: +1 978 624 3400

**Amphenol Canada Corporation**  
605 Milner Avenue  
Toronto, Ontario  
Canada  
M1B 5X6  
T: +1 416 291 4401

## Asia

---

**Amphenol Daeshin, Korea**  
558 SongNae-2 Dong, SoSa-Gu,  
Bucheon City, Gyeonggi-do  
422-040, Korea  
T: +82 32 610 3800

**Amphenol Interconnect India Private Limited**  
105 Bhosari Industrial Area  
Pune 411 026  
India  
T: +91 203 068 8304

**Amphenol Japan**  
471-1 Deba, Ritto-City  
Shiga 520-3041  
Japan  
T: +81 77 553 8501

**Amphenol PCD CO Ltd, China**  
Building 21, 1st Liao Keng  
Industrial Zone, Shi Yan Street  
Bao An District, Shenzhen  
518108  
China  
T: +86 755 8173 8000

## Other areas

---

**Amphenol Argentina**  
Av. Callao 930 2do piso Oficina B  
"Plaza" C1023 – AAP, Buenos  
Aires  
Argentina  
T: +54 11 4815 6886

**Amphenol Australia Pty Limited**  
22 Industry Boulevard  
Carrum Downs, Victoria 3201  
Australia  
T: +61 8796 8888

**Amphenol Do Brazil**  
Rua Diogo Moreira  
132, 20 andar, rooms 2001-2-3  
CEP: 05423 010 Sao Paulo SP  
Brazil  
T: +55 11 3815 1003

**Amphenol Bar-Tec Ltd, Israel**  
3 Hagavish Street, K fir-Barkan Bldg  
East Industrial Zone  
Kfar-Sava, 44102  
Israel  
T: +972 9 764 4100

**Amphenol Mexico**  
Prolongacion Reforma 61-6 B2  
Col Passo de las Lomas  
CP013130  
Mexico  
T: +52 55 5258 9984

**Amphenol Russia**  
Yaroslavskaja Street 8  
129164 Moscow  
Russia  
T: +7 495 937 6341

**Amphenol South Africa**  
30 Impala Road  
2196 Chislehurst  
Sandton  
South Africa  
T: +27 11 783 9517

**Amphenol Turkey**  
Sun Plaza 15 Kat:  
15 Maslak Hah. Bilim  
Sok. No.5  
Sisli/Istanbul, 34398  
Turkey  
T: +90 212 367 92 19

**Amphenol LTD**  
MILITARY & AEROSPACE

For more information call +44 (0)1227 773200  
Amphenol Ltd Thanet Way Whitstable Kent CT5 3JF | Email: [info@amphenol.co.uk](mailto:info@amphenol.co.uk) | [www.amphenol.co.uk](http://www.amphenol.co.uk)